



Price Book

- WORKSURFACES**
- BASIC ELEMENTS**
- LANDMARK SERIES**
- VIZION SERIES**
- ECONOLINE SERIES**
- Rev: 2022.1.1**



General Information

Pricing

All list prices in this price book are Single Color Standard Laminate, F.O.B. our factory, and are subject to change without notice. "Single Color" is the use of one laminate color only throughout the quoted piece. "Standard Laminate" meets three criteria: 1) It is one of the two major brands of high pressure laminate (Wilsonart or Formica). 2) It has a starting grade finish. 3) It is stocked at a local distributor. The use of two or more laminates, and/or the use of non-standard laminates, will increase the list price quoted. Prices do not include shipping or cartoning, which are considered additional charges. Any special quotation or pricing must accompany the written purchase order.

Terms

Upon approved credit, payment terms are net 30. Unpaid balances over 30 days are subject to a service charge of 1-1/2% per month. All orders are invoiced upon completion. All new customers are required to provide a 50% deposit with the order and the balance payable on a C.O.D. basis. A credit application will be provided upon request.

Order Procedure

All orders must be received in writing specifying all necessary information, i.e., model number, edge detail and finish. All orders with missing information will be put on hold until all applicable information is received. Lead time may be extended. All orders will receive an acknowledgement by email. It is the customer's responsibility to review the acknowledgement and inform Action Laminates within 24 to 48 hours of any errors or omissions. Acknowledgements act as the final agreement between the customer and Action Laminates superseding all previous communications.

Changes and Cancellation

Action Laminates must approve change orders and cancellation requests. Authorized change orders will be subject to adjustments in price and lead-time. To change or cancel standard orders, Action Laminates will, at its discretion, levy a restocking charge of 25% or the total costs incurred. Custom projects requiring special materials cannot be changed or cancelled.

Returns

No product may be returned without prior approval by an authorized agent of Action Laminates. Unauthorized returns will be refused.

Shipping

Customers may select any carrier of their choice. It is the responsibility of the carrier to inspect all furniture prior to loading. The responsibility of Action Laminates ceases once the shipment is loaded and signed for by the carrier. Signing for the shipment is acknowledgment that it was received in good condition.

Minimum Order Amount

A minimum amount of \$500 per laminate color is required on each order unless the colors are from the Action Laminates Value Collection, which includes the most common laminates colors and finishes used.

Warranty

Action Laminates warrants its products to be free of defects in materials and workmanship for a period of five years from the date of invoice. The obligation during the warranty period is limited to the repair, or at its option, the replacement of products deemed to be defective by Action Laminates. This warranty does not apply to damage in transit or damage occasioned by the customer.

Storage Charge

From the date of invoice, a 2-week grace period is allowed to pick up product. After 2 weeks, a monthly storage charge will be assessed at a minimum of \$100.00 Net per month or 5% of the total order amount, whichever is higher.



Worksurface Table of Contents

General Information	
Terms	2
Order Procedure	2
Quick Ship	2
Warranty	2
Edge Details and Finish Specifications	4-5
Worksurfaces	
Rectangular	6
Transitional	7
Corners	8-14
Batwing	15
Extended Corners	16-22
Extended Corner Bullet	23-25
Extended Corner P Shape	26-28
Peninsula	29-31
Circular Worksurfaces	
Quarter	32
Half	32
Transaction Counters	
Rectangular	33
Racetrack	33
Curved	34
L-Shaped	34
Extended L-Shaped	35-36
Marker Boards	
Panel Mount	37
Wall Mount	37



phone: (510) 259-6217
email: info@actionlaminates.com

WORKSURFACE EDGE DETAILS AND FINISH SPECIFICATIONS

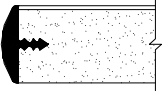
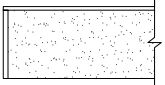
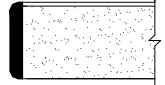
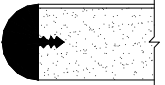
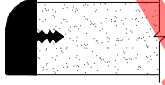
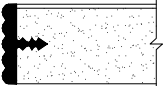
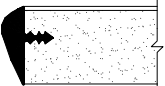

GROUP A	DESCRIPTION	STANDARD COLORS
T-Mold EDGE 1 	Core Material: 45lb high density particle board finished with high pressure laminate top, backing sheet on the bottom. Edge: T-Molding 3/16" x 1 1/8" thick T-Molding 3/16" x 1 1/4" thick.	1 1/8" Edge: Dark Tone, Medium Tone, Light Tone, Innertone-r, Light Grey. 1 1/4" Edge: Almond, Beige, Black, Brown, Charcoal, Clay, Dark Tone, Graphite, Greytone, Innertone Light, Innertone R, Light Grey, Light Tone, Medium Tone, Platinum, Putty, R-Beige, Sand, Smoke, Soft White, Taupe - Lt Tone, White.
Self Edge EDGE 2 	Core Material: 45lb high density particle board finished with high pressure laminate top, backing sheet on the bottom. Edge: High pressure laminate 1/16" x 1 1/4" thick.	High pressure laminate matching the top. Contrasting self edge consult factory for pricing.
GROUP B PVC Edge EDGE 3 	Core Material: 45lb high density particle board finished with high pressure laminate top, backing sheet on the bottom. Edge: PVC 3 mm x 1 1/4" thick.	Antique White, Beigewood, Black, Boardwalk Oak, Cocobala, Designer White, Dove Grey, Fawn Cypress, Figured Mahogany, Fonhill Pear, Frosty White, Fusion Maple, Golden Oak, Grey 1500, Hardrock Maple, Henna Cherry, HM Innertone Light, HM Innertone-R, HM Mediumtone, HW Graphite, HW Putty, HW Smoke, Kensington Maple, Manitoba Maple, Monticello Maple, Pebble, Pepperdust, Platinum, Regency Walnut, River Cherry, Skyline Walnut, Slate, Sterling Ash, Studio Teak, Walnut Heights, Wild Cherry, Windsor Mahogany, Yorkshire Cherry, Witchcraft 1.5mm Satin Chrome
Bullnose T-mold EDGE 4 	Core Material: 45lb high density particle board finished with high pressure laminate top, backing sheet on the bottom. Edge: Bullnose T-Molding 1/2" x 1 1/4" thick.	Black, Gloss Grey
Radius T-mold EDGE 5 	Core Material: 45lb high density particle board finished with high pressure laminate top, backing sheet on the bottom. Edge: Radius T-Molding 1/2" x 1 1/4" thick.	Black
5 Bead T-mold EDGE 6 	Core Material: 45lb high density particle board finished with high pressure laminate top, backing sheet on the bottom. Edge: T-Molding 1/4" x 1 1/4" thick.	Black
Sloped T-mold EDGE 7 	Core Material: 45lb high density particle board finished with high pressure laminate top, backing sheet on the bottom. Edge: T-Molding 3/8" x 1 1/4" thick.	Black

Laminates: Standard matte finishes in solid, wood grain, and patterns from Wilsonart, Formica, Nevamar, and Pionite.
Premium finishes or laminates by Abet laminati, Laminart, and others are available upon request.

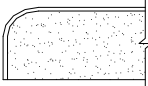

phone: (510) 259-6217
 email: info@actionlaminates.com

WORKSURFACE EDGE DETAILS AND FINISH SPECIFICATIONS

GROUP C	DESCRIPTION	STANDARD COLORS
EDGE 8.0	<p>Radius Post Formed Edge</p>  <p>Core Material: 45lb high density particle board finished with high pressure laminate top, backing sheet on the bottom.</p> <p>Edge: 90 degree, postformed edge 1-1/4".</p>	Continuous high pressure laminate from the top.
EDGE 8.2	<p>Bullnose Post Formed Edge</p>  <p>Core Material: 45lb high density particle board finished with high pressure laminate top, backing sheet on the bottom.</p> <p>Edge: 180 degree, postformed edge 1-1/4".</p>	Continuous high pressure laminate from the top.

Add 10% effective 7/1/2024

Laminates: Standard matte finishes in solid, wood grain, and patterns from Wilsonart, Formica, Nevamar, and Pionite.
 Premium finishes or laminates by Abet laminati, Laminart, and others are available upon request.



phone: (510) 259-6217
email: info@actionlaminates.com

EDGE DETAILS

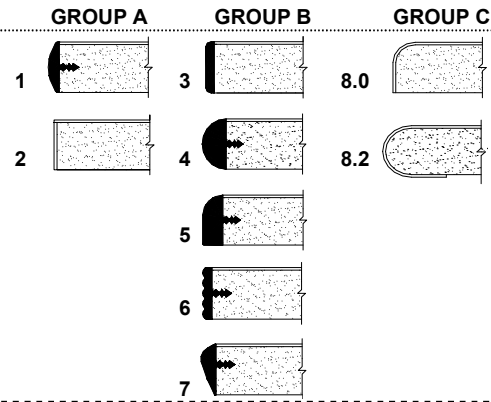

RECTANGULAR WORKSURFACES

MODEL NUMBER	SIZE	WT.	GROUP A	GROUP B	GROUP C
1-2024- □	20 x 24	15	140	150	200
1-2030- □	20 x 30	19	145	155	210
1-2036- □	20 x 36	23	155	170	215
1-2042- □	20 x 42	27	170	185	235
1-2048- □	20 x 48	30	170	185	235
1-2060- □	20 x 60	38	200	230	300
1-2072- □	20 x 72	45	240	270	355
1-2084- □	20 x 84	52	315	360	475
1-2096- □	20 x 96	60	315	360	475
1-2012- □	20 x 120	75	395	455	590
1-2014- □	20 x 144	90	475	545	705
<hr/>					
1-2424- □	24 x 24	18	140	150	200
1-2430- □	24 x 30	23	145	155	210
1-2436- □	24 x 36	27	155	170	215
1-2442- □	24 x 42	32	170	185	235
1-2448- □	24 x 48	36	170	185	235
1-2460- □	24 x 60	45	200	230	300
1-2472- □	24 x 72	54	240	270	355
1-2484- □	24 x 84	63	315	360	475
1-2496- □	24 x 96	72	315	360	475
1-2412- □	24 x 120	90	395	455	590
1-2414- □	24 x 144	108	475	545	705
<hr/>					
1-3030- □	30 x 30	28	170	195	255
1-3036- □	30 x 36	34	180	210	270
1-3042- □	30 x 42	39	195	225	300
1-3048- □	30 x 48	45	195	225	300
1-3060- □	30 x 60	56	250	285	375
1-3072- □	30 x 72	68	300	340	445
1-3084- □	30 x 84	79	395	455	590
1-3096- □	30 x 96	90	395	455	590
1-3012- □	30 x 120	112	495	565	740
1-3014- □	30 x 144	136	590	680	885

OPTIONS:

Round Grommet 3" add \$ 30 List.
For radius corners add \$150 list groups 1-3 .

NOTES:

Please specify edge detail at the end of the model number.
Edge 1, 2, 3 and 6 are perimeter edges.
Edge 4, 5, 7 and Post Formed edges are on one long edge (front edge) only; balance of edges are self edge.



phone: (510) 259-6217
email: info@actionlaminates.com

EDGE DETAILS

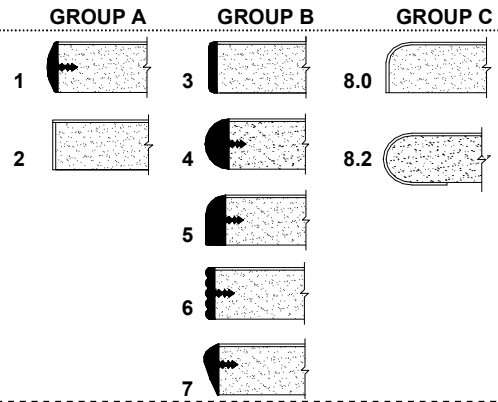

TRANSITIONAL WORKSURFACES

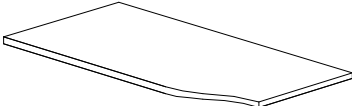
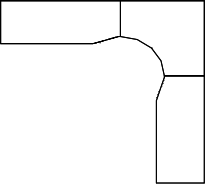
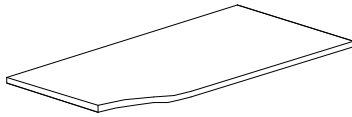
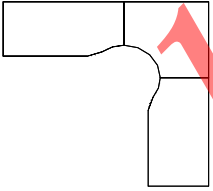
	MODEL NUMBER	SIZE	WT.	GROUP A	GROUP B	GROUP C
24" TO 20"						
 LEFT HAND	2-2436-□	24,20 x 36	27	155	180	-
	2-2442-□	24,20 x 42	32	155	180	-
	2-2448-□	24,20 x 48	36	175	200	-
	2-2460-□	24,20 x 60	45	220	250	-
	2-2472-□	24,20 x 72	54	260	300	-
	2-2484-□	24,20 x 84	63	345	395	-
	2-2496-□	24,20 x 96	72	345	395	-
30" TO 24"						
 AS SHOWN 24" TO 20"	2-3036-□	30,24 x 36	34	195	225	-
	2-3042-□	30,24 x 42	39	220	250	-
	2-3048-□	30,24 x 48	45	220	250	-
	2-3060-□	30,24 x 60	56	270	310	-
	2-3072-□	30,24 x 72	68	325	375	-
	2-3084-□	30,24 x 84	79	430	500	-
	2-3096-□	30,24 x 96	90	430	500	-
24" TO 20"						
 RIGHT HAND	3-2436-□	24,20 x 36	27	155	180	-
	3-2442-□	24,20 x 42	32	155	180	-
	3-2448-□	24,20 x 48	36	175	200	-
	3-2460-□	24,20 x 60	45	220	250	-
	3-2472-□	24,20 x 72	54	260	300	-
	3-2484-□	24,20 x 84	63	345	395	-
	3-2496-□	24,20 x 96	72	345	395	-
30" TO 24"						
 AS SHOWN 30" TO 24"	3-3036-□	30,24 x 36	34	195	225	-
	3-3042-□	30,24 x 42	39	220	250	-
	3-3048-□	30,24 x 48	45	220	250	-
	3-3060-□	30,24 x 60	56	270	310	-
	3-3072-□	30,24 x 72	68	325	375	-
	3-3084-□	30,24 x 84	79	430	500	-
	3-3096-□	30,24 x 96	90	430	500	-

OPTIONS:

Round Grommet 3" add \$ 30 List.

NOTES:

Please specify edge detail at the end of the model number.
Edge 1, 2, 3 and 6 are perimeter edges.
Edge 4, 5, and 7 edges are on one long edge (front edge) only;
balance of edges are self edge.



phone: (510) 259-6217
email: info@actionlaminates.com

EDGE DETAILS

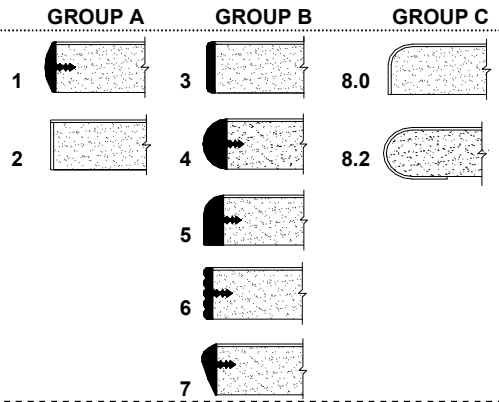

DIAGONAL CORNER WORKSURFACES

	MODEL NUMBER	SIZE	WT.	GROUP A	GROUP B	GROUP C
	4-36-2020- □	36 x 36 x 20 x 20	40	225	260	365
	4-36-2424- □	36 x 36 x 24 x 24	40	225	260	365
	4-36-2024- □	36 x 36 x 20 x 24	40	225	260	365
	4-36-2420- □	36 x 36 x 24 x 20	40	225	260	365
	4-42-2424- □	42 x 42 x 24 x 24	50	375	435	620
	4-42-3030- □	42 x 42 x 30 x 30	50	375	435	620
	4-42-2430- □	42 x 42 x 24 x 30	50	375	435	620
	4-42-3024- □	42 x 42 x 30 x 24	50	375	435	620
	4-48-2424- □	48 x 48 x 24 x 24	67	375	435	620
	4-48-3030- □	48 x 48 x 30 x 30	67	375	435	620
	4-48-2430- □	48 x 48 x 24 x 30	67	375	435	620
	4-48-3024- □	48 x 48 x 30 x 24	67	375	435	620
	4-60-2424- □	60 x 60 x 24 x 24	100	565	650	-
	4-60-3030- □	60 x 60 x 30 x 30	100	565	650	-
	4-60-2430- □	60 x 60 x 24 x 30	100	565	650	-
	4-60-3024- □	60 x 60 x 30 x 24	100	565	650	-

10% Effective 7/1/2024

OPTIONS:

Additional Round Grommet 3" add \$ 30 List.

NOTES:

Standard with one 3" round grommet at the corner.
 Please specify edge detail at the end of the model number.
 Edge 1, 2, 3 and 6 are perimeter edges.
 Edge 4, 5, 7 and Post Formed edges are on diagonal (front) edge only;
 balance of edges are self edge.



phone: (510) 259-6217
email: info@actionlaminates.com

EDGE DETAILS

GROUP A

GROUP B

GROUP C

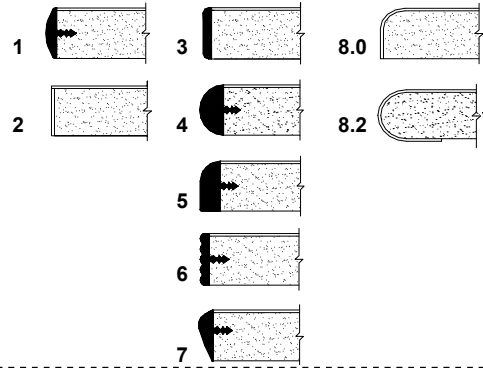

NOTCHED CORNER WORKSURFACES

	MODEL NUMBER	SIZE	WT.	GROUP A	GROUP B	GROUP C
	5-36-2020- <input type="checkbox"/>	36 x 36 x 20 x 20	40	222	257	-
	5-36-2424- <input type="checkbox"/>	36 x 36 x 24 x 24	40	222	257	-
	5-36-2024- <input type="checkbox"/>	36 x 36 x 20 x 24	40	222	257	-
	5-36-2420- <input type="checkbox"/>	36 x 36 x 24 x 20	40	222	257	-
	5-42-2424- <input type="checkbox"/>	42 x 42 x 24 x 24	50	376	433	-
	5-42-3030- <input type="checkbox"/>	42 x 42 x 30 x 30	50	376	433	-
	5-42-2430- <input type="checkbox"/>	42 x 42 x 24 x 30	50	376	433	-
	5-42-3024- <input type="checkbox"/>	42 x 42 x 30 x 24	50	376	433	-
	5-48-2424- <input type="checkbox"/>	48 x 48 x 24 x 24	67	376	433	-
	5-48-3030- <input type="checkbox"/>	48 x 48 x 30 x 30	67	376	433	-
	5-48-2430- <input type="checkbox"/>	48 x 48 x 24 x 30	67	376	433	-
	5-48-3024- <input type="checkbox"/>	48 x 48 x 30 x 24	67	376	433	-
	5-60-2424- <input type="checkbox"/>	60 x 60 x 24 x 24	100	570	656	-
	5-60-3030- <input type="checkbox"/>	60 x 60 x 30 x 30	100	570	656	-
	5-60-2430- <input type="checkbox"/>	60 x 60 x 24 x 30	100	570	656	-
	5-60-3024- <input type="checkbox"/>	60 x 60 x 30 x 24	100	570	656	-

10% Effective 7/1/2024

OPTIONS:

Additional Round Grommet 3" add \$ 30 List.

NOTES:

Standard with one 3" round grommet at the corner.
Please specify edge detail at the end of the model number.
Edge 1, 2, 3 and 6 are perimeter edges.
Edge 4, 5, and 7 edges are on notched (front) edge only;
balance of edges are self edge.



phone: (510) 259-6217
email: info@actionlaminates.com

EDGE DETAILS

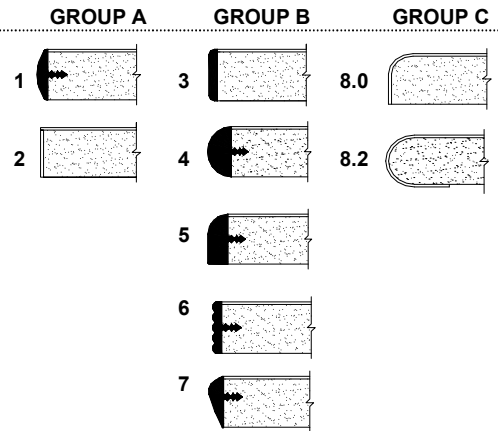

SUPER-SIZED NOTCHED CORNER WORKSURFACES

MODEL NUMBER	SIZE	WT.	GROUP A	GROUP B	GROUP C
5-72-2424 <input type="checkbox"/>	72 x 72 x 24 x 24	100	832	935	-
5-84-2424 <input type="checkbox"/>	84 x 84 x 24 x 24	126	1020	1146	-
5-96-2424 <input type="checkbox"/>	96 x 96 x 24 x 24	135	1037	1169	-

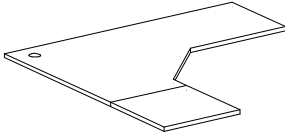

5-72-3030 <input type="checkbox"/>	72 x 72 x 30 x 30	108	844	941	-
5-84-3030 <input type="checkbox"/>	84 x 84 x 30 x 30	137	1060	1191	-
5-96-3030 <input type="checkbox"/>	96 x 96 x 30 x 30	148	1077	1214	-

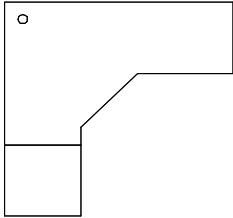

Add effective
 10% effective
 7/1/2024

OPTIONS:

Additional Round Grommet 3" add \$ 30 List.
Permanent seam: add \$60 List.

NOTES:

Standard with one 3" round grommet at the corner.
Standard 2 piece construction with draw-bolt connection at left end.
Please specify edge detail at the end of the model number.
Edge 4, 5, and 7 edges are on notched (front) edge only; balance of edges are self edge.



phone: (510) 259-6217
email: info@actionlaminates.com

EDGE DETAILS

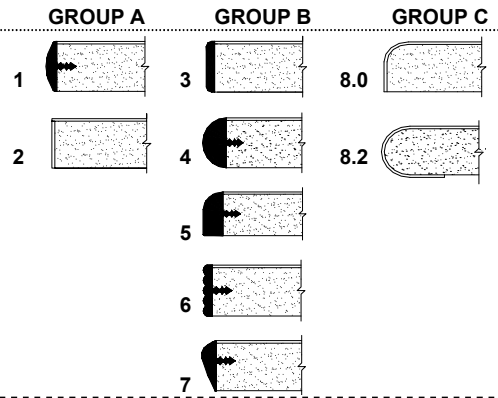

CURVED CORNER WORKSURFACES

	MODEL NUMBER	SIZE	WT.	GROUP A	GROUP B	GROUP C
	6-36-2020- <input type="checkbox"/>	36 x 36 x 20 x 20	40	222	257	-
	6-36-2424- <input type="checkbox"/>	36 x 36 x 24 x 24	40	222	257	-
	6-36-2024- <input type="checkbox"/>	36 x 36 x 20 x 24	40	222	257	-
	6-36-2420- <input type="checkbox"/>	36 x 36 x 24 x 20	40	222	257	-
	6-42-2424- <input type="checkbox"/>	42 x 42 x 24 x 24	50	376	433	-
	6-42-3030- <input type="checkbox"/>	42 x 42 x 30 x 30	50	376	433	-
	6-42-2430- <input type="checkbox"/>	42 x 42 x 24 x 30	50	376	433	-
	6-42-3024- <input type="checkbox"/>	42 x 42 x 30 x 24	50	376	433	-
	6-48-2424- <input type="checkbox"/>	48 x 48 x 24 x 24	67	376	433	-
	6-48-3030- <input type="checkbox"/>	48 x 48 x 30 x 30	67	376	433	-
	6-48-2430- <input type="checkbox"/>	48 x 48 x 24 x 30	67	376	433	-
	6-48-3024- <input type="checkbox"/>	48 x 48 x 30 x 24	67	376	433	-
	6-60-2424- <input type="checkbox"/>	60 x 60 x 24 x 24	100	570	656	-
	6-60-3030- <input type="checkbox"/>	60 x 60 x 30 x 30	100	570	656	-
	6-60-2430- <input type="checkbox"/>	60 x 60 x 24 x 30	100	570	656	-
	6-60-3024- <input type="checkbox"/>	60 x 60 x 30 x 24	100	570	656	-

10% Effective 7/1/2024

OPTIONS:

Additional Round Grommet 3" add \$ 30 List.

NOTES:

Standard with one 3" round grommet at the corner.
Please specify edge detail at the end of the model number.
Edge 1, 2, 3 and 6 are perimeter edges.
Edge 4, 5, and 7 edges are on notched (front) edge only;
balance of edges are self edge.



phone: (510) 259-6217
email: info@actionlaminates.com

EDGE DETAILS

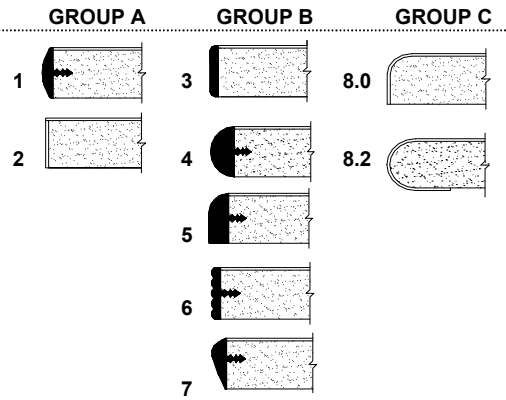

SUPER-SIZED CURVED CORNER WORKSURFACES

MODEL NUMBER	SIZE	WT.	GROUP A	GROUP B	GROUP C
--------------	------	-----	---------	---------	---------

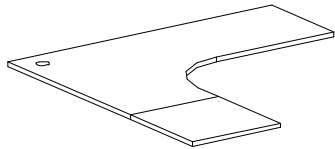

6-72-2424	72 x 72 x 24 x 24	100	832	935	-
6-84-2424	84 x 84 x 24 x 24	126	1020	1146	-
6-96-2424	96 x 96 x 24 x 24	135	1037	1169	-

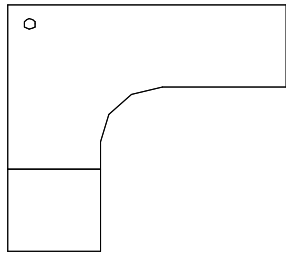

6-72-3030	72 x 72 x 30 x 30	108	844	941	-
6-84-3030	84 x 84 x 30 x 30	137	1060	1191	-
6-96-3030	96 x 96 x 30 x 30	148	1077	1214	-

Add effective 7/1/2024

OPTIONS:

Additional Round Grommet 3" add \$ 30 List.
Permanent seam: add \$60 List.

NOTES:

Standard with one 3" round grommet at the corner.
Standard 2 piece construction with draw-bolt connection at left end.
Please specify edge detail at the end of the model number.
Edge 1, 2, 3 and 6 are perimeter edges.
Edge 4, 5, and 7 edges are on notched (front) edge only; balance of edges are self edge.



phone: (510) 259-6217
email: info@actionlaminates.com

EDGE DETAILS

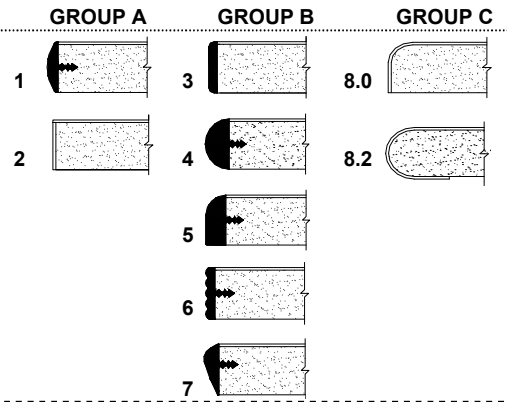

L-SHAPED CORNER WORKSURFACES

	MODEL NUMBER	SIZE	WT.	GROUP A	GROUP B	GROUP C
	39-36-2020- □	36 x 36 x 20 x 20	40	222	257	-
	39-36-2424- □	36 x 36 x 24 x 24	40	222	257	-
	39-36-2024- □	36 x 36 x 20 x 24	40	222	257	-
	39-36-2420- □	36 x 36 x 24 x 20	40	222	257	-
	39-42-2424- □	42 x 42 x 24 x 24	50	376	433	-
	39-42-3030- □	42 x 42 x 30 x 30	50	376	433	-
	39-42-2430- □	42 x 42 x 24 x 30	50	376	433	-
	39-42-3024- □	42 x 42 x 30 x 24	50	376	433	-
	39-48-2424- □	48 x 48 x 24 x 24	67	376	433	-
	39-48-3030- □	48 x 48 x 30 x 30	67	376	433	-
	39-48-2430- □	48 x 48 x 24 x 30	67	376	433	-
	39-48-3024- □	48 x 48 x 30 x 24	67	376	433	-
	39-60-2424- □	60 x 60 x 24 x 24	100	570	656	-
	39-60-3030- □	60 x 60 x 30 x 30	100	570	656	-
	39-60-2430- □	60 x 60 x 24 x 30	100	570	656	-
	39-60-3024- □	60 x 60 x 30 x 24	100	570	656	-

100% Effective 7/11/2024

OPTIONS:

Additional Round Grommet 3" add \$ 30 List.

NOTES:

Standard with one 3" round grommet at the corner.
Please specify edge detail at the end of the model number.
Edge 1, 2, 3 and 6 are perimeter edges.
Edge 4, 5, and 7 edges are on notched (front) edge only;
balance of edges are self edge.



phone: (510) 259-6217
email: info@actionlaminates.com

EDGE DETAILS

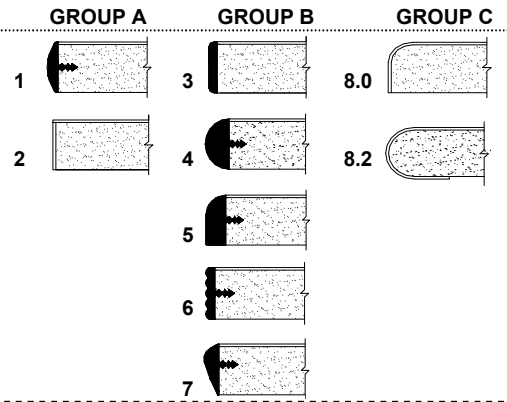

SUPER-SIZED L-SHAPED CORNER WORKSURFACES

	MODEL NUMBER	SIZE	WT.	GROUP A	GROUP B	GROUP C
	39-□72-2424-□	72 x 72 x 24 x 24	90	581	638	-
	39-□84-2424-□	84 x 84 x 24 x 24	108	701	781	-
	39-□96-2424-□	96 x 96 x 24 x 24	126	735	821	-
<hr/>						
	39-□72-3030-□	72 x 72 x 30 x 30	113	684	758	-
	39-□84-3030-□	84 x 84 x 30 x 30	135	827	918	-
	39-□96-3030-□	96 x 96 x 30 x 30	158	878	980	-

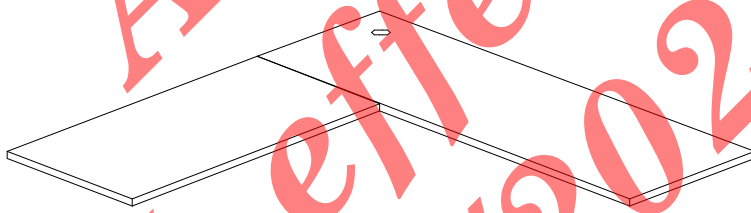

Add 10% effective 7/1/2024

OPTIONS:

Additional Round Grommet 3" add \$ 30 List.
Permanent seam: add \$60 List.

NOTES:

Standard with one 3" round grommet at the corner.
Standard 2 piece construction with draw-bolt connection at left end.
Please specify edge detail at the end of the model number.
Edge 1, 2, 3 and 6 are perimeter edges.
Edge 4, 5, and 7 edges are on front edge only;
balance of edges are self edge.



phone: (510) 259-6217
 email: info@actionlaminates.com

EDGE DETAILS

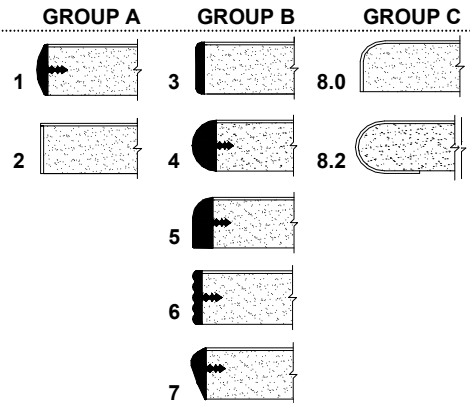

120 DEGREE BATWING WORKSURFACES

MODEL NUMBER	SIZE	WT.	GROUP A	GROUP B	GROUP C
--------------	------	-----	---------	---------	---------

	Width x Interface				
38-4824- □	48 x 24	53	690	764	-
38-4830- □	48 x 30	70	861	941	-
38-6024- □	60 x 24	74	1077	1186	-
38-6030- □	60 x 30	98	1077	1186	-

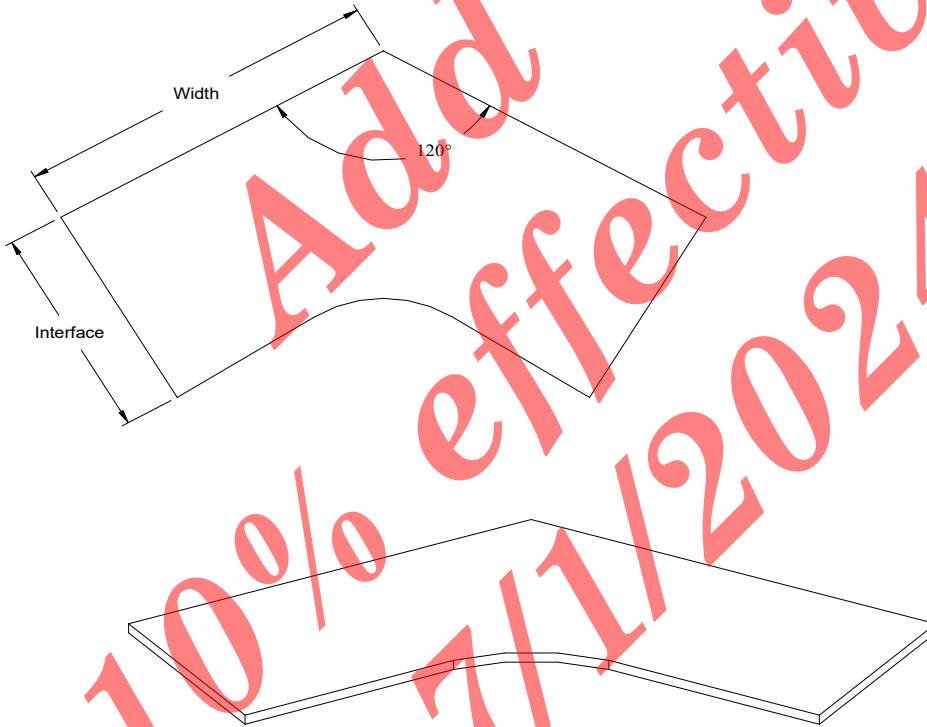

Add effective 10% 7/1/2024

OPTIONS:

Round Grommet 3" add \$ 30 List.

NOTES:

Please specify edge detail at the end of the model number.



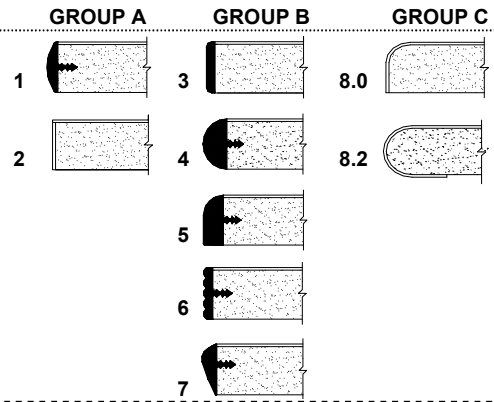

phone: (510) 259-6217
email: info@actionlaminates.com

EDGE DETAILS

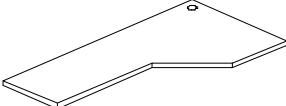
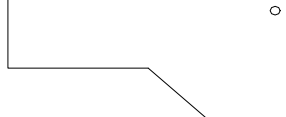
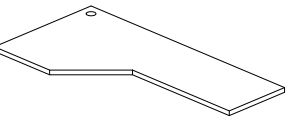
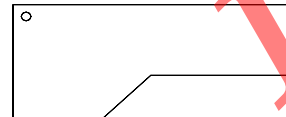
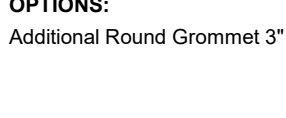

EXTENDED DIAGONAL CORNER WORKSURFACES

	MODEL NUMBER	SIZE	WT.	GROUP A	GROUP B	GROUP C
 Left Extension Shown	8-□-3648-2020- □	36 x 48 x 20 x 20	54	285	331	-
	8-□-3648-2424- □	36 x 48 x 24 x 24	54	285	331	-
	8-□-3648-2024- □	36 x 48 x 20 x 24	54	285	331	-
	8-□-3648-2420- □	36 x 48 x 24 x 20	54	285	331	-
 Left Extension Shown	8-□-3660-2020- □	36 x 60 x 20 x 20	63	353	405	-
	8-□-3660-2424- □	36 x 60 x 24 x 24	63	353	405	-
	8-□-3660-2024- □	36 x 60 x 20 x 24	63	353	405	-
	8-□-3660-2420- □	36 x 60 x 24 x 20	63	353	405	-
 Right Extension Shown	8-□-3672-2020- □	36 x 72 x 20 x 20	72	416	479	-
	8-□-3672-2424- □	36 x 72 x 24 x 24	72	416	479	-
	8-□-3672-2024- □	36 x 72 x 20 x 24	72	416	479	-
	8-□-3672-2420- □	36 x 72 x 24 x 20	72	416	479	-
 Right Extension Shown	8-□-3696-2020- □	36 x 96 x 20 x 20	90	547	627	-
	8-□-3696-2424- □	36 x 96 x 24 x 24	90	547	627	-
	8-□-3696-2024- □	36 x 96 x 20 x 24	90	547	627	-
	8-□-3696-2420- □	36 x 96 x 24 x 20	90	547	627	-
 Right Extension Shown	8-□-4860-2424- □	48 x 60 x 24 x 24	76	462	530	-
	8-□-4860-3030- □	48 x 60 x 30 x 30	76	462	530	-
	8-□-4860-2430- □	48 x 60 x 24 x 30	76	462	530	-
	8-□-4860-3024- □	48 x 60 x 30 x 24	76	462	530	-
 Right Extension Shown	8-□-4872-2424- □	48 x 72 x 24 x 24	85	547	627	-
	8-□-4872-3030- □	48 x 72 x 30 x 30	85	547	627	-
	8-□-4872-2430- □	48 x 72 x 24 x 30	85	547	627	-
	8-□-4872-3024- □	48 x 72 x 30 x 24	85	547	627	-
 Right Extension Shown	8-□-4896-2424- □	48 x 96 x 24 x 24	103	718	827	-
	8-□-4896-3030- □	48 x 96 x 30 x 30	103	718	827	-
	8-□-4896-2430- □	48 x 96 x 24 x 30	103	718	827	-
	8-□-4896-3024- □	48 x 96 x 30 x 24	103	718	827	-

OPTIONS:

Additional Round Grommet 3" add \$ 30 List.

NOTES:

Standard with one 3" round grommet at the corner.
Please specify left or right extension: add "L" or "R" after "8" in model number
Please specify edge detail at the end of the model number.
Edge 1, 2, 3 and 6 are perimeter edges.
Edge 4, 5, and 7 edges are on diagonal (front) edge only; balance of edges are self edge.



phone: (510) 259-6217
email: info@actionlaminates.com

EDGE DETAILS

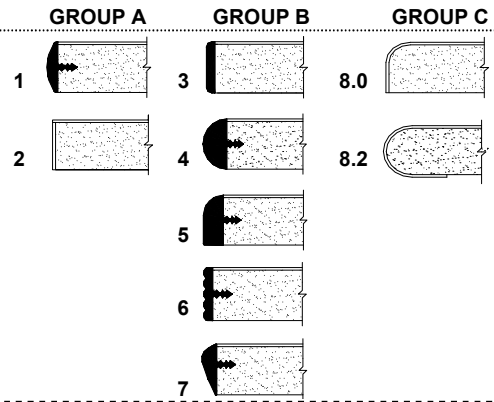

EXTENDED NOTCHED CORNER WORKSURFACES

	MODEL NUMBER	SIZE	WT.	GROUP A	GROUP B	GROUP C
<p>Left Extension Shown</p>	9-□-4860-2424- □	48 x 60 x 24 x 24	76	462	530	-
	9-□-4860-3030- □	48 x 60 x 30 x 30	76	462	530	-
	9-□-4860-2430- □	48 x 60 x 24 x 30	76	462	530	-
	9-□-4860-3024- □	48 x 60 x 30 x 24	76	462	530	-
<p>Right Extension Shown</p>	9-□-4872-2424- □	48 x 72 x 24 x 24	85	547	627	-
	9-□-4872-3030- □	48 x 72 x 30 x 30	85	547	627	-
	9-□-4872-2430- □	48 x 72 x 24 x 30	85	547	627	-
	9-□-4872-3024- □	48 x 72 x 30 x 24	85	547	627	-
	9-□-4896-2424- □	48 x 96 x 24 x 24	103	718	827	-
	9-□-4896-3030- □	48 x 96 x 30 x 30	103	718	827	-
	9-□-4896-2430- □	48 x 96 x 24 x 30	103	718	827	-
	9-□-4896-3024- □	48 x 96 x 30 x 24	103	718	827	-
	9-□-6072-2424- □	60 x 72 x 24 x 24	111	678	775	-
	9-□-6072-3030- □	60 x 72 x 30 x 30	111	678	775	-
	9-□-6072-2430- □	60 x 72 x 24 x 30	111	678	775	-
	9-□-6072-3024- □	60 x 72 x 30 x 24	111	678	775	-
	9-□-6084-2424- □	60 x 84 x 24 x 24	122	889	1026	-
	9-□-6084-3030- □	60 x 84 x 30 x 30	122	889	1026	-
	9-□-6084-2430- □	60 x 84 x 24 x 30	122	889	1026	-
	9-□-6084-3024- □	60 x 84 x 30 x 24	122	889	1026	-
	9-□-6096-2424- □	60 x 96 x 24 x 24	133	889	1026	-
	9-□-6096-3030- □	60 x 96 x 30 x 30	133	889	1026	-
	9-□-6096-2430- □	60 x 96 x 24 x 30	133	889	1026	-
	9-□-6096-3024- □	60 x 96 x 30 x 24	133	889	1026	-

OPTIONS:

Additional Round Grommet 3" add \$ 30 List.

NOTES:

Standard with one 3" round grommet at the corner.
Please specify left or right extension: add "L" or "R" after "9" in model number
Please specify edge detail at the end of the model number.
Edge 1, 2, 3 and 6 are perimeter edges.
Edge 4, 5, and 7 edges are on diagonal (front) edge only; balance of edges are self edge.



phone: (510) 259-6217
email: info@actionlaminates.com

EDGE DETAILS

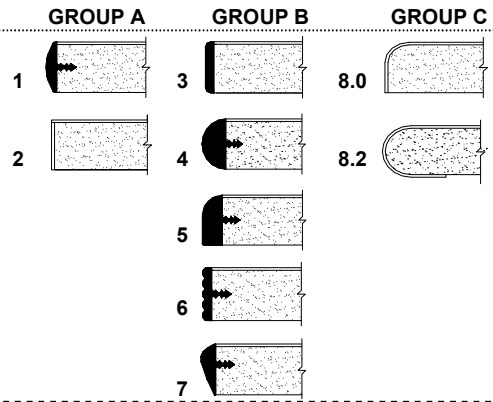

SUPER-SIZED EXTENDED NOTCHED CORNER WORKSURFACES

MODEL NUMBER	SIZE	WT.	GROUP A	GROUP B	GROUP C
--------------	------	-----	---------	---------	---------

9-□-7284-2424-□	72 x 84 x 24 x 24	108	866	958	-
9-□-7296-2424-□	72 x 96 x 24 x 24	117	866	958	-
9-□-8496-2424-□	84 x 96 x 24 x 24	135	901	992	-

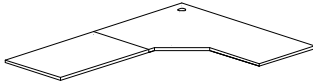

Left Extension Shown

9-□-7284-3030-□	72 x 84 x 30 x 30	119	1026	1146	-
9-□-7296-3030-□	72 x 96 x 30 x 30	130	1026	1146	-
9-□-8496-3030-□	84 x 96 x 30 x 30	148	1060	1197	-

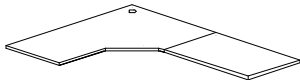
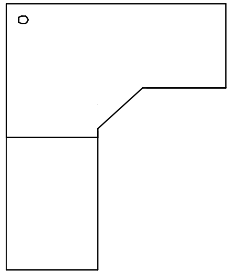

Right Extension Shown

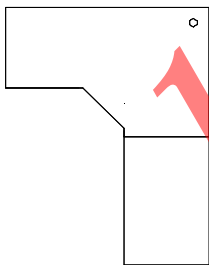

Add 10% effective 7/1/2024

OPTIONS:

Additional Round Grommet 3" add \$ 30 List.
Permanent seam: add \$60 List.

NOTES:

Standard with one 3" round grommet at the corner.
Standard 2 piece construction with draw-bolt connection at left end for left extension, right end for right extension.
Please specify left or right extension: add "L" or "R" after "9" in model number.
Please specify edge detail at the end of the model number.
Edge 1, 2, 3 and 6 are perimeter edges.
Edge 4, 5, and 7 edges are on diagonal (front) edge only; balance of edges are self edge.



phone: (510) 259-6217
email: info@actionlaminates.com

EDGE DETAILS

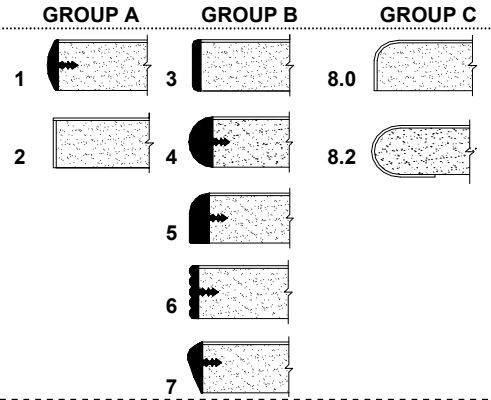

EXTENDED CURVED CORNER WORKSURFACES

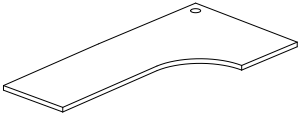
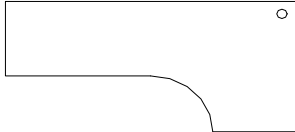
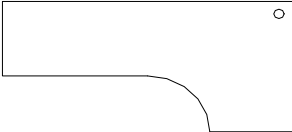
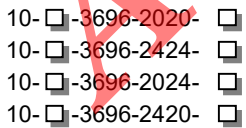
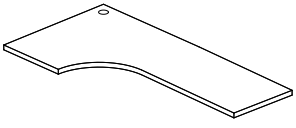
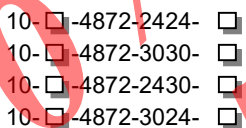
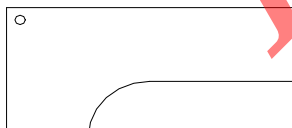
	MODEL NUMBER	SIZE	WT.	GROUP A	GROUP B	GROUP C
 Left Extension Shown	10-□-3648-2020-□	36 x 48 x 20 x 20	54	285	331	-
	10-□-3648-2424-□	36 x 48 x 24 x 24	54	285	331	-
	10-□-3648-2024-□	36 x 48 x 20 x 24	54	285	331	-
	10-□-3648-2420-□	36 x 48 x 24 x 20	54	285	331	-
 Left Extension Shown	10-□-3660-2020-□	36 x 60 x 20 x 20	63	353	405	-
	10-□-3660-2424-□	36 x 60 x 24 x 24	63	353	405	-
	10-□-3660-2024-□	36 x 60 x 20 x 24	63	353	405	-
	10-□-3660-2420-□	36 x 60 x 24 x 20	63	353	405	-
 Left Extension Shown	10-□-3672-2020-□	36 x 72 x 20 x 20	72	416	479	-
	10-□-3672-2424-□	36 x 72 x 24 x 24	72	416	479	-
	10-□-3672-2024-□	36 x 72 x 20 x 24	72	416	479	-
	10-□-3672-2420-□	36 x 72 x 24 x 20	72	416	479	-
 Left Extension Shown	10-□-3696-2020-□	36 x 96 x 20 x 20	90	547	627	-
	10-□-3696-2424-□	36 x 96 x 24 x 24	90	547	627	-
	10-□-3696-2024-□	36 x 96 x 20 x 24	90	547	627	-
	10-□-3696-2420-□	36 x 96 x 24 x 20	90	547	627	-
 Right Extension Shown	10-□-4860-2424-□	48 x 60 x 24 x 24	76	462	530	-
	10-□-4860-3030-□	48 x 60 x 30 x 30	76	462	530	-
	10-□-4860-2430-□	48 x 60 x 24 x 30	76	462	530	-
	10-□-4860-3024-□	48 x 60 x 30 x 24	76	462	530	-
 Right Extension Shown	10-□-4872-2424-□	48 x 72 x 24 x 24	85	547	627	-
	10-□-4872-3030-□	48 x 72 x 30 x 30	85	547	627	-
	10-□-4872-2430-□	48 x 72 x 24 x 30	85	547	627	-
	10-□-4872-3024-□	48 x 72 x 30 x 24	85	547	627	-
 Right Extension Shown	10-□-4896-2424-□	48 x 96 x 24 x 24	103	718	827	-
	10-□-4896-3030-□	48 x 96 x 30 x 30	103	718	827	-
	10-□-4896-2430-□	48 x 96 x 24 x 30	103	718	827	-
	10-□-4896-3024-□	48 x 96 x 30 x 24	103	718	827	-

OPTIONS:

Additional Round Grommet 3" add \$ 30 List.

NOTES:

Standard with one 3" round grommet at the corner.
 Please specify left or right extension: add "L" or "R" after "10" in model number
 Please specify edge detail at the end of the model number.
 Edge 1, 2, 3 and 6 are perimeter edges.
 Edge 4, 5, and 7 edges are on curved (front) edge only; balance of edges are self edge.



phone: (510) 259-6217
email: info@actionlaminates.com

EDGE DETAILS

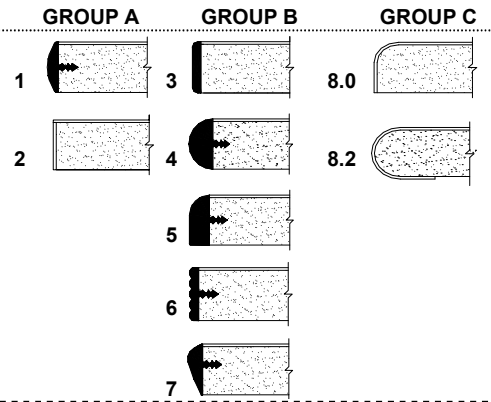

SUPER-SIZED EXTENDED CURVED CORNER WORKSURFACES

MODEL NUMBER	SIZE	WT.	GROUP A	GROUP B	GROUP C
--------------	------	-----	---------	---------	---------

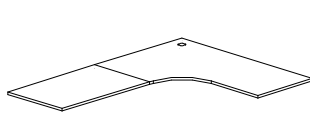

10- □-7284-2424-	□ 72 x 84 x 24 x 24	108	866	958	-
10- □-7296-2424-	□ 72 x 96 x 24 x 24	117	866	958	-
10- □-8496-2424-	□ 84 x 96 x 24 x 24	135	901	992	-

Left Extension Shown

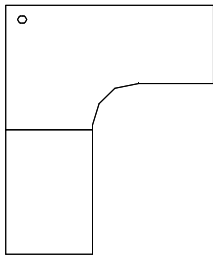

10- □-7284-3030-	□ 72 x 84 x 30 x 30	119	1026	1146	-
10- □-7296-3030-	□ 72 x 96 x 30 x 30	130	1026	1146	-
10- □-8496-3030-	□ 84 x 96 x 30 x 30	148	1060	1197	-

Add 10% effective 7/1/2024

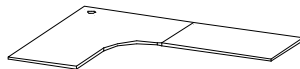

Right Extension Shown

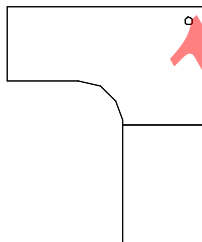

OPTIONS:

Additional Round Grommet 3" add \$ 30 List.
Permanent seam: add \$60 List.

NOTES:

Standard with one 3" round grommet at the corner.
Standard 2 piece construction with draw-bolt connection at left end for left extension, right end for right extension.
Please specify left or right extension: add "L" or "R" after "10" in model number
Please specify edge detail at the end of the model number.
Edge 1, 2, 3 and 6 are perimeter edges.
Edge 4, 5, and 7 edges are on curved (front) edge only; balance of edges are self edge.



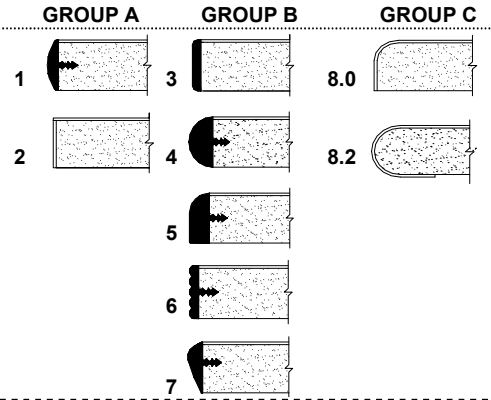

phone: (510) 259-6217
email: info@actionlaminates.com

EDGE DETAILS

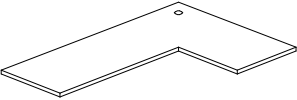
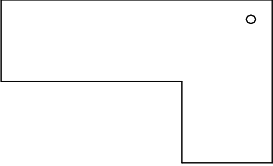
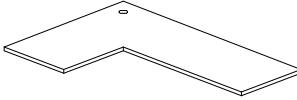
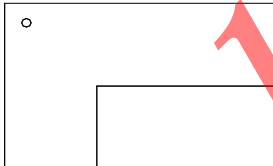
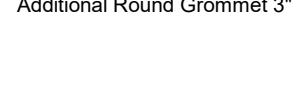

EXTENDED L-SHAPED CORNER WORKSURFACES

	MODEL NUMBER	SIZE	WT.	GROUP A	GROUP B	GROUP C
 <p>Left Extension Shown</p>	40-□-3648-2020-□	36 x 48 x 20 x 20	54	285	331	-
	40-□-3648-2424-□	36 x 48 x 24 x 24	54	285	331	-
	40-□-3648-2024-□	36 x 48 x 20 x 24	54	285	331	-
	40-□-3648-2420-□	36 x 48 x 24 x 20	54	285	331	-
 <p>Right Extension Shown</p>	40-□-3660-2020-□	36 x 60 x 20 x 20	63	353	405	-
	40-□-3660-2424-□	36 x 60 x 24 x 24	63	353	405	-
	40-□-3660-2024-□	36 x 60 x 20 x 24	63	353	405	-
	40-□-3660-2420-□	36 x 60 x 24 x 20	63	353	405	-
 <p>Left Extension Shown</p>	40-□-3672-2020-□	36 x 72 x 20 x 20	72	416	479	-
	40-□-3672-2424-□	36 x 72 x 24 x 24	72	416	479	-
	40-□-3672-2024-□	36 x 72 x 20 x 24	72	416	479	-
	40-□-3672-2420-□	36 x 72 x 24 x 20	72	416	479	-
 <p>Right Extension Shown</p>	40-□-3696-2020-□	36 x 96 x 20 x 20	90	547	627	-
	40-□-3696-2424-□	36 x 96 x 24 x 24	90	547	627	-
	40-□-3696-2024-□	36 x 96 x 20 x 24	90	547	627	-
	40-□-3696-2420-□	36 x 96 x 24 x 20	90	547	627	-
 <p>Left Extension Shown</p>	40-□-4860-2424-□	48 x 60 x 24 x 24	76	462	530	-
	40-□-4860-3030-□	48 x 60 x 30 x 30	76	462	530	-
	40-□-4860-2430-□	48 x 60 x 24 x 30	76	462	530	-
	40-□-4860-3024-□	48 x 60 x 30 x 24	76	462	530	-
 <p>Right Extension Shown</p>	40-□-4872-2424-□	48 x 72 x 24 x 24	85	547	627	-
	40-□-4872-3030-□	48 x 72 x 30 x 30	85	547	627	-
	40-□-4872-2430-□	48 x 72 x 24 x 30	85	547	627	-
	40-□-4872-3024-□	48 x 72 x 30 x 24	85	547	627	-
<p>Left Extension Shown</p>	40-□-4896-2424-□	48 x 96 x 24 x 24	103	718	827	-
	40-□-4896-3030-□	48 x 96 x 30 x 30	103	718	827	-
	40-□-4896-2430-□	48 x 96 x 24 x 30	103	718	827	-
	40-□-4896-3024-□	48 x 96 x 30 x 24	103	718	827	-

OPTIONS:

Additional Round Grommet 3" add \$ 30 List.

NOTES:

Standard with one 3" round grommet at the corner.
Please specify left or right extension: add "L" or "R" after "40" in model number
Please specify edge detail at the end of the model number.
Edge 1, 2, 3 and 6 are perimeter edges.
Edge 4, 5, and 7 edges are on curved (front) edge only; balance of edges are self edge.



phone: (510) 259-6217
email: info@actionlaminates.com

EDGE DETAILS

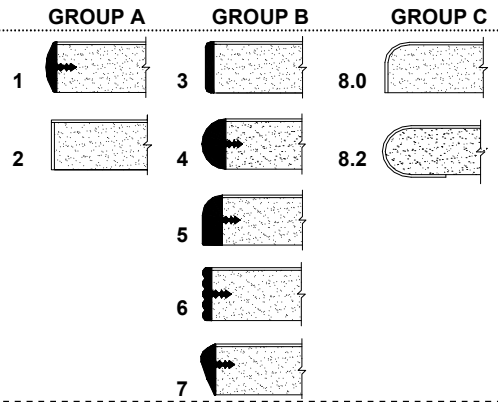

SUPER-SIZED EXTENDED L-SHAPED WORKSURFACES

	MODEL NUMBER	SIZE	WT.	GROUP A	GROUP B	GROUP C
--	--------------	------	-----	---------	---------	---------

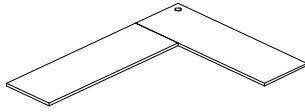

Left Extension Shown

40-□-7284-2424- □	72 x 84 x 24 x 24	100	621	690	-
40-□-7296-2424- □	72 x 96 x 24 x 24	108	661	730	-
40-□-8496-2424- □	84 x 96 x 24 x 24	117	741	821	-

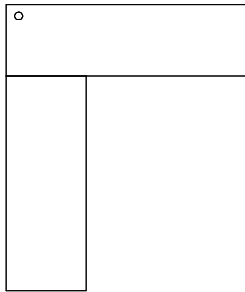

Right Extension Shown

40-□-7284-3030- □	72 x 84 x 30 x 30	124	730	809	-
40-□-7296-3030- □	72 x 96 x 30 x 30	136	781	866	-
40-□-8496-3030- □	84 x 96 x 30 x 30	147	878	980	-

Add 10% effective 7/1/2024

OPTIONS:

Additional Round Grommet 3" add \$ 30 List.
Permanent seam: add \$60 List.

NOTES:

Standard with one 3" round grommet at the corner.
Standard 2 piece construction with draw-bolt connection at left end for left extension, right end for right extension.
Please specify edge detail at the end of the model number.
Edge 1, 2, 3 and 6 are perimeter edges.
Edge 4, 5, and 7 edges are on front edge only; balance of edges are self edge.



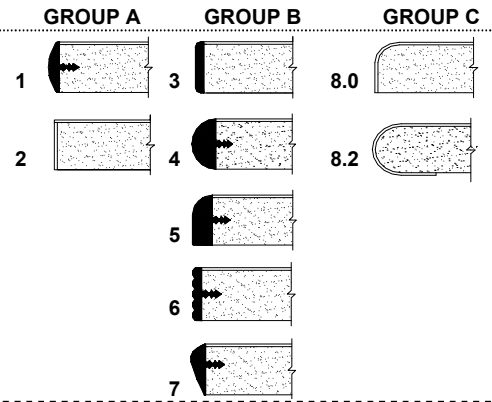

phone: (510) 259-6217
email: info@actionlaminates.com

EDGE DETAILS

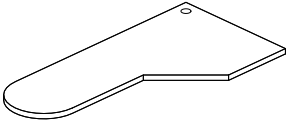
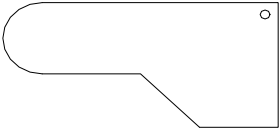
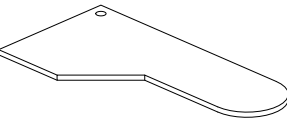
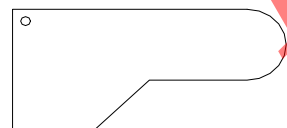

EXTENDED DIAGONAL CORNER BULLET WORKSURFACES

	MODEL NUMBER	SIZE	WT.	GROUP A	GROUP B	GROUP C
 Left Extension Shown	11-□-3660-2020-□	36 x 60 x 20 x 20	63	428	496	-
	11-□-3660-2424-□	36 x 60 x 24 x 24	63	428	496	-
	11-□-3660-2024-□	36 x 60 x 20 x 24	63	428	496	-
	11-□-3660-2420-□	36 x 60 x 24 x 20	63	428	496	-
 Right Extension Shown	11-□-3672-2020-□	36 x 72 x 20 x 20	72	490	570	-
	11-□-3672-2424-□	36 x 72 x 24 x 24	72	490	570	-
	11-□-3672-2024-□	36 x 72 x 20 x 24	72	490	570	-
	11-□-3672-2420-□	36 x 72 x 24 x 20	72	490	570	-
 Left Extension Shown	11-□-3696-2020-□	36 x 96 x 20 x 20	90	621	713	-
	11-□-3696-2424-□	36 x 96 x 24 x 24	90	621	713	-
	11-□-3696-2024-□	36 x 96 x 20 x 24	90	621	713	-
	11-□-3696-2420-□	36 x 96 x 24 x 20	90	621	713	-
 Right Extension Shown	11-□-4860-2424-□	48 x 60 x 24 x 24	76	536	616	-
	11-□-4860-3030-□	48 x 60 x 30 x 30	76	536	616	-
	11-□-4860-2430-□	48 x 60 x 24 x 30	76	536	616	-
	11-□-4860-3024-□	48 x 60 x 30 x 24	76	536	616	-
 Left Extension Shown	11-□-4872-2424-□	48 x 72 x 24 x 24	85	621	713	-
	11-□-4872-3030-□	48 x 72 x 30 x 30	85	621	713	-
	11-□-4872-2430-□	48 x 72 x 24 x 30	85	621	713	-
	11-□-4872-3024-□	48 x 72 x 30 x 24	85	621	713	-
 Right Extension Shown	11-□-4896-2424-□	48 x 96 x 24 x 24	103	792	912	-
	11-□-4896-3030-□	48 x 96 x 30 x 30	103	792	912	-
	11-□-4896-2430-□	48 x 96 x 24 x 30	103	792	912	-
	11-□-4896-3024-□	48 x 96 x 30 x 24	103	792	912	-

OPTIONS:

Additional Round Grommet 3" add \$ 30 List.

NOTES:

Standard with one 3" round grommet at the corner.
 Please specify left or right extension: add "L" or "R" after "11" in model number
 Please specify edge detail at the end of the model number.
 Edge 1, 2, 3 and 6 are perimeter edges.
 Edge 4, 5, and 7 edges are on user edges only; balance of edges are self edge.



phone: (510) 259-6217
email: info@actionlaminates.com

EDGE DETAILS

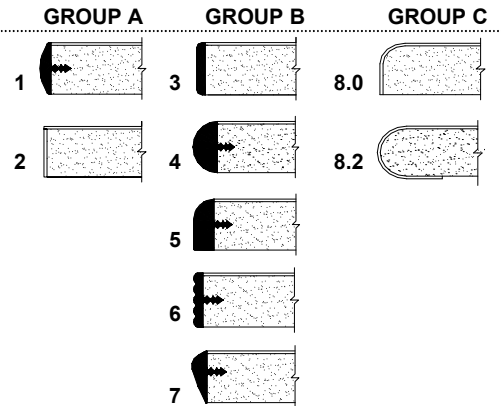

**EXTENDED NOTCHED CORNER
BULLET WORKSURFACES**

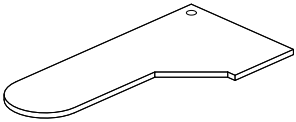
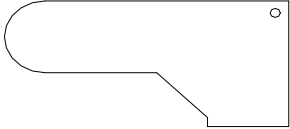
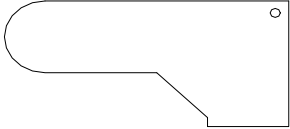
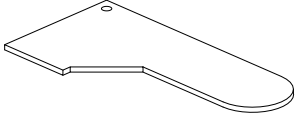
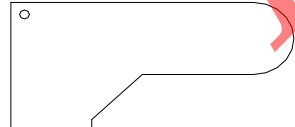
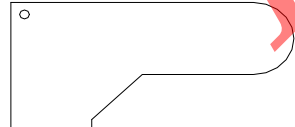
	MODEL NUMBER	SIZE	WT.	GROUP A	GROUP B	GROUP C
 Left Extension Shown	12-□-4860-2424-□	48 x 60 x 24 x 24	76	536	616	-
	12-□-4860-3030-□	48 x 60 x 30 x 30	76	536	616	-
	12-□-4860-2430-□	48 x 60 x 24 x 30	76	536	616	-
	12-□-4860-3024-□	48 x 60 x 30 x 24	76	536	616	-
 Left Extension Shown	12-□-4872-2424-□	48 x 72 x 24 x 24	85	621	713	-
	12-□-4872-3030-□	48 x 72 x 30 x 30	85	621	713	-
	12-□-4872-2430-□	48 x 72 x 24 x 30	85	621	713	-
	12-□-4872-3024-□	48 x 72 x 30 x 24	85	621	713	-
 Left Extension Shown	12-□-4896-2424-□	48 x 96 x 24 x 24	103	792	912	-
	12-□-4896-3030-□	48 x 96 x 30 x 30	103	792	912	-
	12-□-4896-2430-□	48 x 96 x 24 x 30	103	792	912	-
	12-□-4896-3024-□	48 x 96 x 30 x 24	103	792	912	-
 Right Extension Shown	12-□-6072-2424-□	60 x 72 x 24 x 24	111	752	866	-
	12-□-6072-3030-□	60 x 72 x 30 x 30	111	752	866	-
	12-□-6072-2430-□	60 x 72 x 24 x 30	111	752	866	-
	12-□-6072-3024-□	60 x 72 x 30 x 24	111	752	866	-
 Right Extension Shown	12-□-6084-2424-□	60 x 84 x 24 x 24	122	969	1112	-
	12-□-6084-3030-□	60 x 84 x 30 x 30	122	969	1112	-
	12-□-6084-2430-□	60 x 84 x 24 x 30	122	969	1112	-
	12-□-6084-3024-□	60 x 84 x 30 x 24	122	969	1112	-
 Right Extension Shown	12-□-6096-2424-□	60 x 96 x 24 x 24	133	969	1112	-
	12-□-6096-3030-□	60 x 96 x 30 x 30	133	969	1112	-
	12-□-6096-2430-□	60 x 96 x 24 x 30	133	969	1112	-
	12-□-6096-3024-□	60 x 96 x 30 x 24	133	969	1112	-

OPTIONS:

Additional Round Grommet 3" add \$ 30 List.

NOTES:

Standard with one 3" round grommet at the corner.
 Please specify left or right extension: add "L" or "R" after "12" in model number
 Please specify edge detail at the end of the model number.
 Edge 1, 2, 3 and 6 are perimeter edges.
 Edge 4, 5, and 7 edges are on user edges only;
 balance of edges are self edge.



phone: (510) 259-6217
email: info@actionlaminates.com

EDGE DETAILS

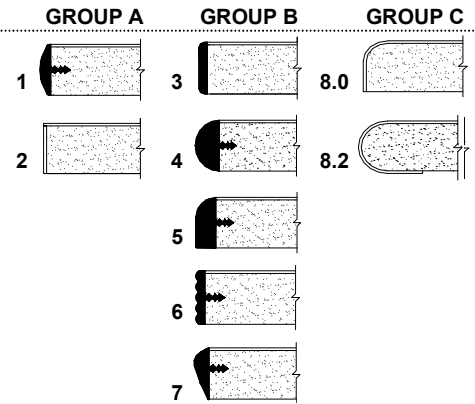

**EXTENDED CURVED CORNER
BULLET WORKSURFACES**

	MODEL NUMBER	SIZE	WT.	GROUP A	GROUP B	GROUP C
	13-□-3660-2020-□	36 x 60 x 20 x 20	63	428	496	-
	13-□-3660-2424-□	36 x 60 x 24 x 24	63	428	496	-
	13-□-3660-2024-□	36 x 60 x 20 x 24	63	428	496	-
	13-□-3660-2420-□	36 x 60 x 24 x 20	63	428	496	-
Left Extension Shown	13-□-3672-2020-□	36 x 72 x 20 x 20	72	490	570	-
	13-□-3672-2424-□	36 x 72 x 24 x 24	72	490	570	-
	13-□-3672-2024-□	36 x 72 x 20 x 24	72	490	570	-
	13-□-3672-2420-□	36 x 72 x 24 x 20	72	490	570	-
	13-□-3696-2020-□	36 x 96 x 20 x 20	90	621	713	-
	13-□-3696-2424-□	36 x 96 x 24 x 24	90	621	713	-
	13-□-3696-2024-□	36 x 96 x 20 x 24	90	621	713	-
	13-□-3696-2420-□	36 x 96 x 24 x 20	90	621	713	-
	13-□-4860-2424-□	48 x 60 x 24 x 24	76	536	621	-
	13-□-4860-3030-□	48 x 60 x 30 x 30	76	536	621	-
	13-□-4860-2430-□	48 x 60 x 24 x 30	76	536	621	-
	13-□-4860-3024-□	48 x 60 x 30 x 24	76	536	621	-
Right Extension Shown	13-□-4872-2424-□	48 x 72 x 24 x 24	85	621	713	-
	13-□-4872-3030-□	48 x 72 x 30 x 30	85	621	713	-
	13-□-4872-2430-□	48 x 72 x 24 x 30	85	621	713	-
	13-□-4872-3024-□	48 x 72 x 30 x 24	85	621	713	-
	13-□-4896-2424-□	48 x 96 x 24 x 24	103	792	912	-
	13-□-4896-3030-□	48 x 96 x 30 x 30	103	792	912	-
	13-□-4896-2430-□	48 x 96 x 24 x 30	103	792	912	-
	13-□-4896-3024-□	48 x 96 x 30 x 24	103	792	912	-

OPTIONS:

Additional Round Grommet 3" add \$ 30 List.

NOTES:

Standard with one 3" round grommet at the corner.
Please specify left or right extension: add "L" or "R" after "13" in model number.
Please specify edge detail at the end of the model number.
Edge 1, 2, 3 and 6 are perimeter edges.
Edge 4, 5, and 7 edges are on user edges only; balance of edges are self edge.



phone: (510) 259-6217
email: info@actionlaminates.com

EDGE DETAILS

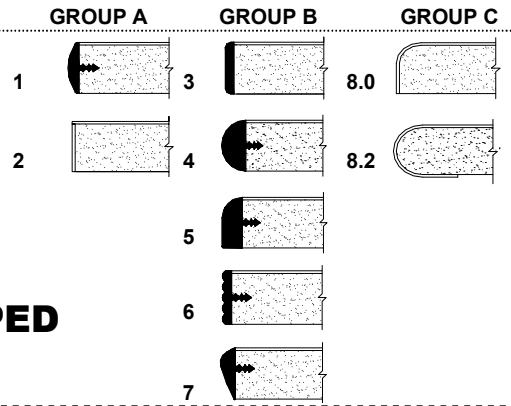

EXTENDED DIAGONAL CORNER P-SHAPED WORKSURFACES

MODEL NUMBER	SIZE	WT.	GROUP A	GROUP B	GROUP C
	A X B X C X D X E				
14-□-3672-2424-36-□	36 x 72 x 24 x 24 x 36	80	621	713	-
14-□-3684-2424-36-□	36 x 84 x 24 x 24 x 36	95	792	912	-
14-□-3696-2424-36-□	36 x 96 x 24 x 24 x 36	108	792	912	-
14-□-4272-2424-36-□	42 x 72 x 24 x 24 x 36	95	752	866	-
14-□-4272-3024-36-□	42 x 72 x 30 x 24 x 36	95	752	866	-
14-□-4296-2424-36-□	42 x 96 x 24 x 24 x 36	95	969	1112	-
14-□-4296-3024-36-□	42 x 96 x 30 x 24 x 36	95	969	1112	-
14-□-4284-2424-42-□	42 x 84 x 24 x 24 x 42	110	969	1112	-
14-□-4284-3030-42-□	42 x 84 x 30 x 30 x 42	110	969	1112	-
14-□-4296-2424-42-□	42 x 96 x 24 x 24 x 42	126	969	1112	-
14-□-4296-3030-42-□	42 x 96 x 30 x 30 x 42	126	969	1112	-
14-□-4896-3030-42-□	48 x 96 x 30 x 30 x 42	144	969	1112	-

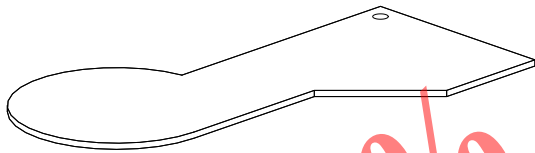

Left Extension Shown

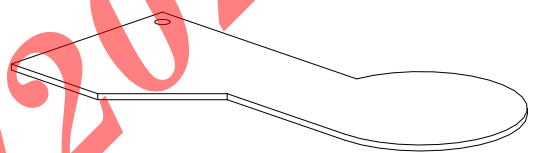

Right Extension Shown

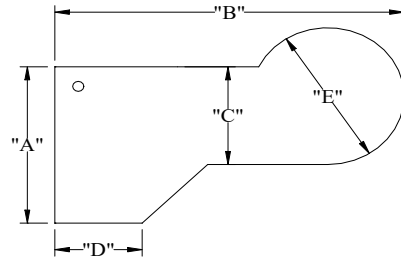
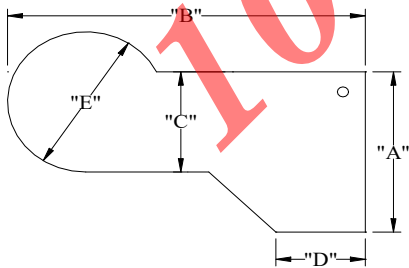

OPTIONS:

Additional Round Grommet 3" add \$ 30 List.

NOTES:

- Standard with one 3" grommet at the corner.
- Please specify left or right extension: add "L" or "R" after "14" in model number.
- Please specify edge detail at the end of the model number.
- Edge 1, 2, 3 and 6 are perimeter edges.
- Edge 4, 5, and 7 edges are on user edges only; balance of edges are self edge.



phone: (510) 259-6217
email: info@actionlaminates.com

EDGE DETAILS

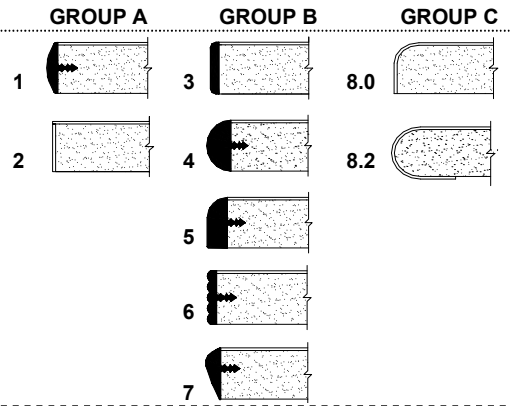

**EXTENDED NOTCHED CORNER
P-SHAPED WORKSURFACES**

MODEL NUMBER	SIZE	WT.	GROUP A	GROUP B	GROUP C
	A X B X C X D X E				
15-□-3672-2424-36-□	36 x 72 x 24 x 24 x 36	80	621	713	-
15-□-3684-2424-36-□	36 x 84 x 24 x 24 x 36	95	792	912	-
15-□-3696-2424-36-□	36 x 96 x 24 x 24 x 36	108	792	912	-
15-□-4272-2424-36-□	42 x 72 x 24 x 24 x 36	95	752	866	-
15-□-4272-3024-36-□	42 x 72 x 30 x 24 x 36	95	752	866	-
15-□-4296-2424-36-□	42 x 96 x 24 x 24 x 36	95	969	1112	-
15-□-4296-3024-36-□	42 x 96 x 30 x 24 x 36	95	969	1112	-
15-□-4284-2424-42-□	42 x 84 x 24 x 24 x 42	110	969	1112	-
15-□-4284-3030-42-□	42 x 84 x 30 x 30 x 42	110	969	1112	-
15-□-4296-2424-42-□	42 x 96 x 24 x 24 x 42	126	969	1112	-
15-□-4296-3030-42-□	42 x 96 x 30 x 30 x 42	126	969	1112	-
15-□-4896-3030-42-□	48 x 96 x 30 x 30 x 42	144	969	1112	-

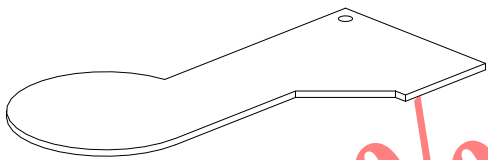

Left Extension Shown

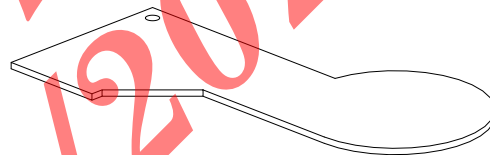

Right Extension Shown

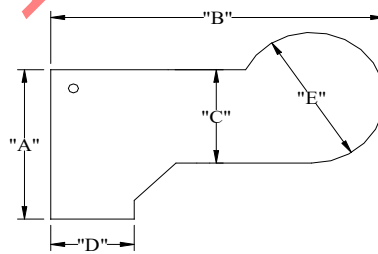
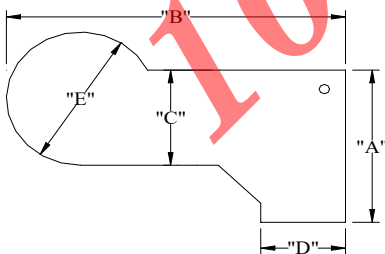

OPTIONS:

Additional Round Grommet 3" add \$ 30 List.

NOTES:

Standard with one 3" grommet at the corner.

Please specify left or right extension: add "L" or "R" after "15" in model number.

Please specify edge detail at the end of the model number.

Edge 1, 2, 3 and 6 are perimeter edges.

Edge 4, 5, and 7 edges are on user edges only; balance of edges are self edge.



phone: (510) 259-6217
email: info@actionlaminates.com

EDGE DETAILS

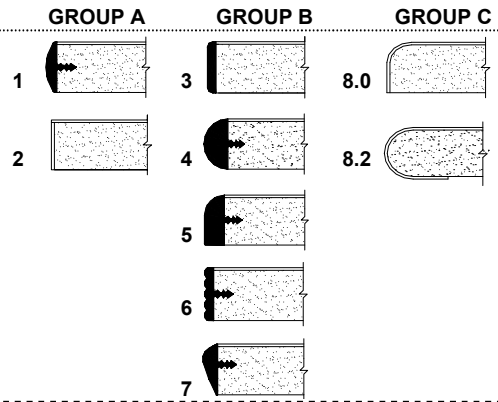

**EXTENDED CURVED CORNER
P- SHAPED WORKSURFACES**

MODEL NUMBER	SIZE	WT.	GROUP A	GROUP B	GROUP C
	A X B X C X D X E				
16-□-3672-2424-36-□	36 x 72 x 24 x 24 x 36	80	621	713	-
16-□-3684-2424-36-□	36 x 84 x 24 x 24 x 36	95	792	912	-
16-□-3696-2424-36-□	36 x 96 x 24 x 24 x 36	108	792	912	-
16-□-4272-2424-36-□	42 x 72 x 24 x 24 x 36	95	752	866	-
16-□-4272-3024-36-□	42 x 72 x 30 x 24 x 36	95	752	866	-
16-□-4296-2424-36-□	42 x 96 x 24 x 24 x 36	95	969	1112	-
16-□-4296-3024-36-□	42 x 96 x 30 x 24 x 36	95	969	1112	-
16-□-4284-2424-42-□	42 x 84 x 24 x 24 x 42	110	969	1112	-
16-□-4284-3030-42-□	42 x 84 x 30 x 30 x 42	110	969	1112	-
16-□-4296-2424-42-□	42 x 96 x 24 x 24 x 42	126	969	1112	-
16-□-4296-3030-42-□	42 x 96 x 30 x 30 x 42	126	969	1112	-
16-□-4896-3030-42-□	48 x 96 x 30 x 30 x 42	144	969	1112	-

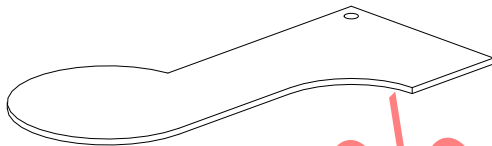

Left Extension Shown

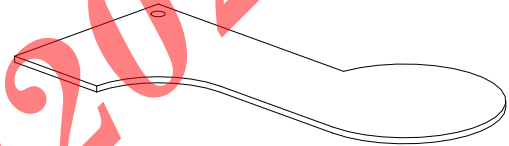

Right Extension Shown

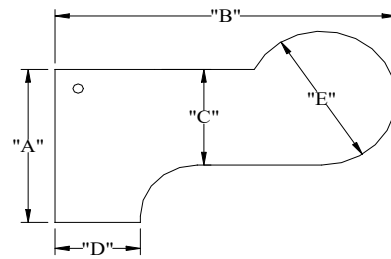
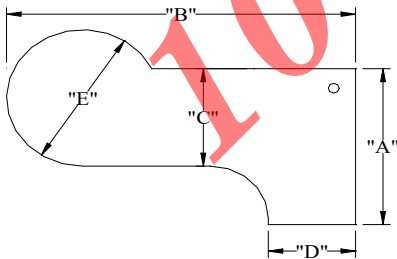

OPTIONS:

Additional Round Grommet 3" add \$ 30 List.

NOTES:

Standard with one 3" grommet at the corner.

Please specify left or right extension: add "L" or "R" after "16" in model number.

Please specify edge detail at the end of the model number.

Edge 1, 2, 3 and 6 are perimeter edges.

Edge 4, 5, and 7 edges are on user edges only; balance of edges are self edge.



phone: (510) 259-6217
email: info@actionlaminates.com

EDGE DETAILS

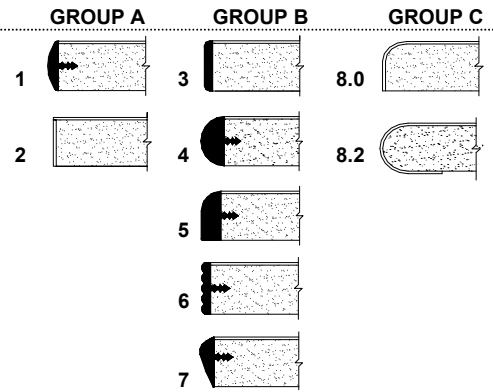

**PENINSULA WORKSURFACES
BULLET WORKSURFACES**

BULLET SHAPE	MODEL NUMBER	SIZE	WT.	GROUP A	GROUP B	GROUP C
	17-2030- <input type="checkbox"/>	20 x 30	19	211	245	-
	17-2036- <input type="checkbox"/>	20 x 36	23	217	251	-
	17-2042- <input type="checkbox"/>	20 x 42	27	234	268	-
	17-2048- <input type="checkbox"/>	20 x 48	31	234	268	-
	17-2436- <input type="checkbox"/>	24 x 36	28	217	251	-
	17-2442- <input type="checkbox"/>	24 x 42	32	234	268	-
	17-2448- <input type="checkbox"/>	24 x 48	37	234	268	-
	17-2460- <input type="checkbox"/>	24 x 60	46	274	314	-
	17-2472- <input type="checkbox"/>	24 x 72	55	314	359	-
	17-2484- <input type="checkbox"/>	24 x 84	65	388	450	-
	17-2496- <input type="checkbox"/>	24 x 96	74	388	450	-
		17-3036- <input type="checkbox"/>	30 x 36	35	251	291
17-3042- <input type="checkbox"/>		30 x 42	40	274	314	-
17-3048- <input type="checkbox"/>		30 x 48	46	274	314	-
17-3060- <input type="checkbox"/>		30 x 60	58	319	371	-
17-3072- <input type="checkbox"/>		30 x 72	69	371	428	-
17-3084- <input type="checkbox"/>		30 x 84	81	467	536	-
17-3096- <input type="checkbox"/>		30 x 96	92	467	536	-
		17-3660- <input type="checkbox"/>	36 x 60	69	382	445
	17-3672- <input type="checkbox"/>	36 x 72	83	445	513	-
	17-3684- <input type="checkbox"/>	36 x 84	97	564	644	-
	17-3696- <input type="checkbox"/>	36 x 96	110	564	644	-
	17-4860- <input type="checkbox"/>	48 x 60	92	507	542	-
	17-4872- <input type="checkbox"/>	48 x 72	110	593	638	-
	17-4884- <input type="checkbox"/>	48 x 84	130	747	821	-
	17-4896- <input type="checkbox"/>	48 x 96	148	747	821	-
	17-6084- <input type="checkbox"/>	60 x 84	138	923	1003	-
	17-6096- <input type="checkbox"/>	60 x 96	162	923	1003	-
	17-60120- <input type="checkbox"/>	60 x 120	250	1123	1231	-
	17-60144- <input type="checkbox"/>	60 x 144	300	1334	1465	-

OPTIONS:

Round Grommet 3" add \$ 30 List.

NOTES:

Please specify edge detail at the end of model number.
Edge 1, 2, 3 and 6 are perimeter edges.
Edge 4, 5, and 7 edges are on user edges only;
balance of edges are self edge.
Edge 8.0 and 8.2 are long edges only
balance of edges are self edge.



phone: (510) 259-6217
email: info@actionlaminates.com

EDGE DETAILS

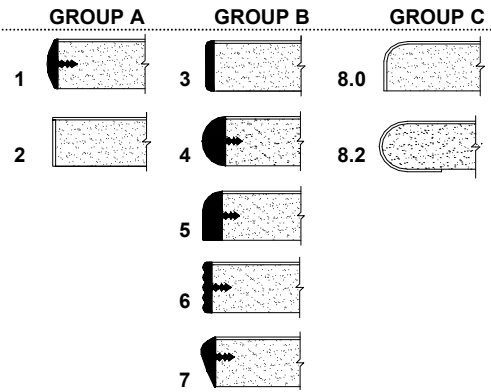

**PENINSULA WORKSURFACES
CONVEX WORKSURFACES**

	MODEL NUMBER	SIZE	WT.	GROUP A	GROUP B	GROUP C
	18-2030- <input type="checkbox"/>	20 x 30	19	211	245	319
	18-2036- <input type="checkbox"/>	20 x 36	23	217	251	325
	18-2042- <input type="checkbox"/>	20 x 42	27	234	268	348
	18-2048- <input type="checkbox"/>	20 x 48	31	234	268	348
	18-2436- <input type="checkbox"/>	24 x 36	28	217	251	325
	18-2442- <input type="checkbox"/>	24 x 42	32	234	268	348
	18-2448- <input type="checkbox"/>	24 x 48	37	234	268	348
	18-2460- <input type="checkbox"/>	24 x 60	46	274	314	410
	18-2472- <input type="checkbox"/>	24 x 72	55	314	359	467
	18-2484- <input type="checkbox"/>	24 x 84	65	388	450	587
	18-2496- <input type="checkbox"/>	24 x 96	74	388	450	581
		18-3036- <input type="checkbox"/>	30 x 36	35	251	291
18-3042- <input type="checkbox"/>		30 x 42	40	274	314	410
18-3048- <input type="checkbox"/>		30 x 48	46	274	314	410
18-3060- <input type="checkbox"/>		30 x 60	58	319	371	485
18-3072- <input type="checkbox"/>		30 x 72	69	371	428	553
18-3084- <input type="checkbox"/>		30 x 84	81	467	536	701
18-3096- <input type="checkbox"/>		30 x 96	92	467	536	701
		18-3660- <input type="checkbox"/>	36 x 60	69	382	445
	18-3672- <input type="checkbox"/>	36 x 72	83	445	513	661
	18-3684- <input type="checkbox"/>	36 x 84	97	564	644	844
	18-3696- <input type="checkbox"/>	36 x 96	110	564	644	844
	18-4860- <input type="checkbox"/>	48 x 60	92	507	542	599
	18-4872- <input type="checkbox"/>	48 x 72	110	593	638	695
	18-4884- <input type="checkbox"/>	48 x 84	130	747	821	901
	18-4896- <input type="checkbox"/>	48 x 96	148	747	821	901
	18-6084- <input type="checkbox"/>	60 x 84	138	923	1003	1100
	18-6096- <input type="checkbox"/>	60 x 96	162	923	1003	1100
	18-60120- <input type="checkbox"/>	60 x 120	250	1123	1231	1334
	18-60144- <input type="checkbox"/>	60 x 144	300	1334	1465	1602

OPTIONS:

Round Grommet 3" add \$ 30 List.

NOTES:

Please specify edge detail at the end of model number.
Edge 1, 2, 3 and 6 are perimeter edges.
Edge 4, 5, and 7 edges are on user edges only;
balance of edges are self edge.
Edge 8.0 and 8.2 are long edges only
balance of edges are self edge.





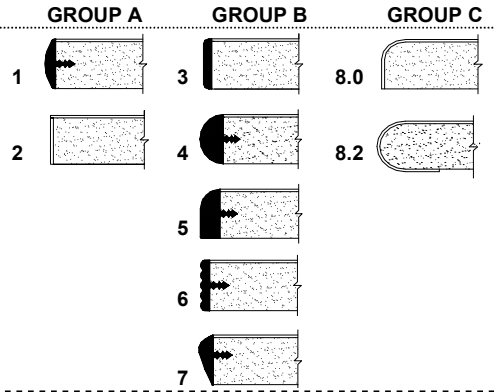

phone: (510) 259-6217
email: info@actionlaminates.com

EDGE DETAILS

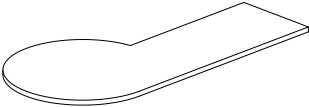

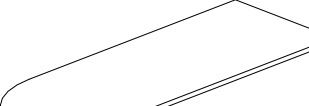
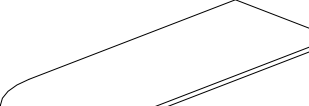
PENINSULA WORKSURFACES

	MODEL NUMBER	SIZE	WT.	GROUP A	GROUP B	GROUP C
P SHAPE						
		D, DIA. x W				
 Left Extension Shown	19-□-2472-□	24, 36 x 72	81	462	530	-
	19-□-2484-□	24, 36 x 84	95	587	678	-
	19-□-2496-□	24, 36 x 96	108	587	678	-
 Right Extension Shown	19-□-3072-□	30, 42 x 72	95	587	678	-
	19-□-3084-□	30, 42 x 84	110	770	884	-
	19-□-3096-□	30, 42 x 96	126	770	884	-
 Right Extension Shown	19-□-3672-□	36, 48 x 72	108	587	678	-
	19-□-3684-□	36, 48 x 84	126	770	884	-
	19-□-3696-□	36, 48 x 96	144	770	884	-
J SHAPE						
		D, DIA. x W				
 Left Extension Shown	20-□-2472-□	24, 36 x 72	81	462	530	-
	20-□-2484-□	24, 36 x 84	95	587	678	-
	20-□-2496-□	24, 36 x 96	108	587	678	-
 Left Extension Shown	20-□-3072-□	30, 42 x 72	95	587	678	-
	20-□-3084-□	30, 42 x 84	110	770	884	-
	20-□-3096-□	30, 42 x 96	126	770	884	-
 Right Extension Shown	20-□-3672-□	36, 48 x 72	108	587	678	-
	20-□-3684-□	36, 48 x 84	126	770	884	-
	20-□-3696-□	36, 48 x 96	144	770	884	-

OPTIONS:

Round Grommet 3" add \$ 30 List.

NOTES:

Please specify left or right extension: add "L" or "R" after "19" or "20" in model number.
Please specify edge detail at the end of the model number.
Edge 1, 2, 3 and 6 are perimeter edges.
Edge 4, 5, and 7 edges are on user edges only;
balance of edges are self edge.



phone: (510) 259-6217
email: info@actionlaminates.com

EDGE DETAILS

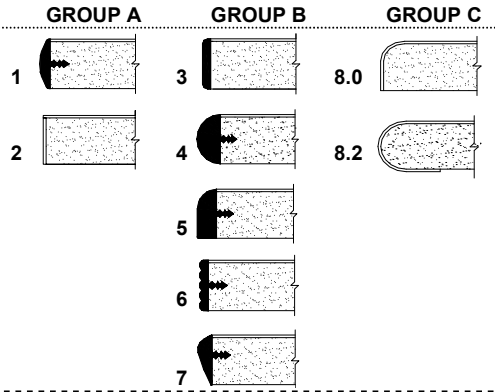

CIRCULAR WORKSURFACES

	MODEL NUMBER	SIZE	WT.	GROUP A	GROUP B	GROUP C
--	--------------	------	-----	---------	---------	---------

QUARTER ROUND

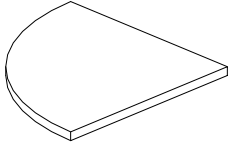

21-24-☐	24 x 24	18	205	234	-
21-30-☐	30 x 30	28	239	279	-
21-36-☐	36 x 36	41	251	291	-
21-48-☐	48 x 48	72	388	450	-

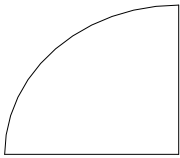

HALF ROUND

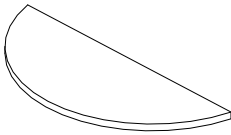

22-2448-☐	24 x 48	36	234	268	-
22-2460-☐	24 x 60	45	274	314	-
22-3060-☐	30 x 60	56	319	371	-
22-3072-☐	30 x 72	68	371	428	-

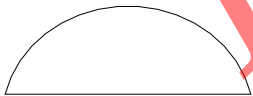

OPTIONS:

Round Grommet 3" add \$ 30 List.

NOTES:

Please specify edge detail at the end of the model number.

Edge 1, 2, 3 and 6 are perimeter edges.

Edge 4, 5, and 7 edges are on curved edge only; balance of edges are self edge.



phone: (510) 259-6217
email: info@actionlaminates.com

EDGE DETAILS

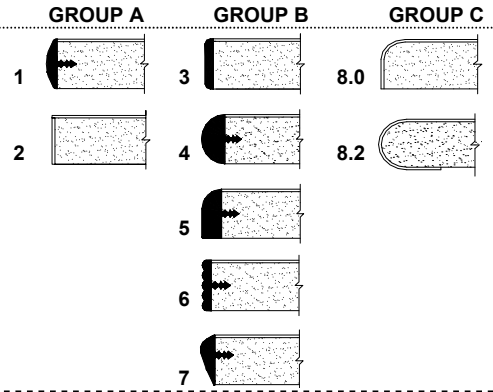

TRANSACTION COUNTER TOPS

	MODEL NUMBER	SIZE	WT.	GROUP A	GROUP B	GROUP C
RECTANGULAR						
	23-1224- <input type="checkbox"/>	12 x 24	9	103	114	148
	23-1230- <input type="checkbox"/>	12 x 30	11	108	125	165
	23-1236- <input type="checkbox"/>	12 x 36	14	114	131	171
	23-1242- <input type="checkbox"/>	12 x 42	16	125	148	194
	23-1248- <input type="checkbox"/>	12 x 48	18	125	148	194
	23-1260- <input type="checkbox"/>	12 x 60	18	154	177	228
	23-1272- <input type="checkbox"/>	12 x 72	27	188	217	279
	23-1284- <input type="checkbox"/>	12 x 84	32	257	296	382
	23-1296- <input type="checkbox"/>	12 x 96	36	257	296	382
	23-12120- <input type="checkbox"/>	12 x 120	45	319	371	479
	23-12144- <input type="checkbox"/>	12 x 144	54	382	445	576

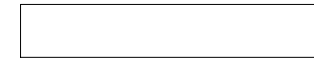

RACETRACK

	24-1224- <input type="checkbox"/>	12 x 24	9	143	165	-
	24-1230- <input type="checkbox"/>	12 x 30	11	154	177	-
	24-1236- <input type="checkbox"/>	12 x 36	14	160	182	-
	24-1242- <input type="checkbox"/>	12 x 42	16	171	200	-
	24-1248- <input type="checkbox"/>	12 x 48	18	171	200	-
	24-1260- <input type="checkbox"/>	12 x 60	18	200	228	-
	24-1272- <input type="checkbox"/>	12 x 72	27	234	268	-
	24-1284- <input type="checkbox"/>	12 x 84	32	302	348	-
	24-1296- <input type="checkbox"/>	12 x 96	36	302	348	-
	24-12120- <input type="checkbox"/>	12 x 120	45	365	422	-
	24-12144- <input type="checkbox"/>	12 x 144	54	428	496	-



OPTIONS:

Round Grommet 3" add \$ 30 List.

NOTES:

Please specify edge detail at the end of the model number.

Rectangular: Edge 1, 2, 3 and 6 are perimeter edges.

Rectangular: Edge 4, 5, 7 and Post Formed edges are on one long edge (front edge) only; balance of edges are self edge.

Racetrack: Edge 1, 2, 3, 4, 5, 6, and 7 are perimeter edges.



phone: (510) 259-6217
email: info@actionlaminates.com

EDGE DETAILS

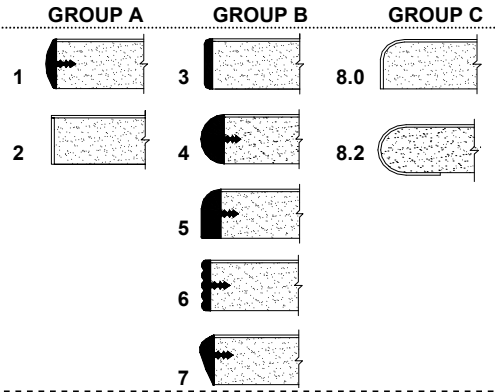

TRANSACTION COUNTER TOPS

	MODEL NUMBER	SIZE	WT.	GROUP A	GROUP B	GROUP C
L-SHAPED						
	25-1232- <input type="checkbox"/>	12 x 31.5	20	194	222	-
	25-1238- <input type="checkbox"/>	12 x 37.5	23	348	399	-
	25-1244- <input type="checkbox"/>	12 x 43.5	26	348	365	-
	25-1256- <input type="checkbox"/>	12 x 55.5	33	536	616	-
L-SHAPED W/ RADIUS						
	26-1232- <input type="checkbox"/>	12 x 31.5	20	239	274	-
	26-1238- <input type="checkbox"/>	12 x 37.5	23	388	450	-
	26-1244- <input type="checkbox"/>	12 x 43.5	26	388	450	-
	26-1256- <input type="checkbox"/>	12 x 55.5	33	581	673	-
CURVED						
	27-1232- <input type="checkbox"/>	12 x 31.5	23	239	274	-
	27-1238- <input type="checkbox"/>	12 x 37.5	25	388	450	-

OPTIONS:

Round Grommet 3" add \$ 30 List.

NOTES:

Please specify edge detail at the end of the model number.
Edge 1, 2, 3 and 6 are perimeter edges.
Edge 4, 5, and 7 edges are on outside edges only;
balance of edges are self edge.

L-SHAPED W/ RADIUS: standard with 6" radius corner.



phone: (510) 259-6217
email: info@actionlaminates.com

EDGE DETAILS

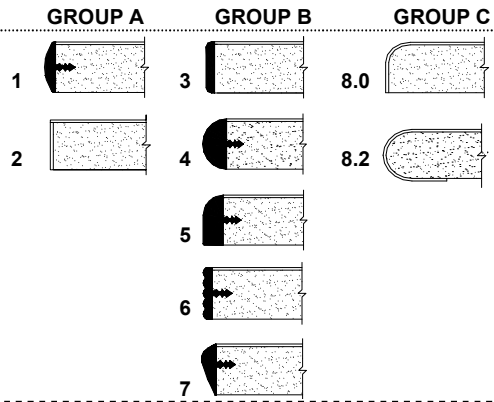

TRANSACTION COUNTER TOPS

	MODEL NUMBER	SIZE	WT.	GROUP A	GROUP B	GROUP C
EXTENDED L-SHAPED						
	25-□-12-3238-□	12 x 31.5 x 37.5	20	257	296	-
	25-□-12-3244-□	12 x 31.5 x 43.5	22	257	296	-
	25-□-12-3256-□	12 x 31.5 x 55.5	27	319	371	-
	25-□-12-3268-□	12 x 31.5 x 67.5	32	382	445	-
	25-□-12-3280-□	12 x 31.5 x 79.5	37	513	587	-
	25-□-12-3288-□	12 x 31.5 x 87.5	42	513	587	-
	25-□-12-3210-□	12 x 31.5 x 103.5	47	656	752	-
<hr/>						
	25-□-12-3844-□	12 x 37.5 x 43.5	26	348	399	-
	25-□-12-3856-□	12 x 37.5 x 55.5	30	428	496	-
	25-□-12-3868-□	12 x 37.5 x 67.5	34	513	587	-
	25-□-12-3880-□	12 x 37.5 x 79.5	40	690	792	-
	25-□-12-3888-□	12 x 37.5 x 87.5	45	690	792	-
	25-□-12-3810-□	12 x 37.5 x 103.5	50	872	1003	-
	<hr/>					
LEFT EXTENSION SHOWN ABOVE						
	25-□-12-4456-□	12 x 43.5 x 55.5	33	428	496	-
	25-□-12-4468-□	12 x 43.5 x 67.5	37	513	587	-
	25-□-12-4480-□	12 x 43.5 x 79.5	43	690	792	-
	25-□-12-4488-□	12 x 43.5 x 87.5	48	690	792	-
	25-□-12-4410-□	12 x 43.5 x 103.5	53	872	1003	-
<hr/>						
	25-□-12-5668-□	12 x 55.5 x 67.5	41	644	741	-
	25-□-12-5680-□	12 x 55.5 x 79.5	47	861	986	-
	25-□-12-5688-□	12 x 55.5 x 87.5	52	861	986	-
	25-□-12-5610-□	12 x 55.5 x 103.5	57	1083	1243	-

OPTIONS:
Round Grommet 3" add \$ 30 List.

NOTES:
Please specify left or right extension: add "L" or "R" after "25" in model number.
Please specify edge detail at the end of the model number.
Edge 1, 2, 3 and 6 are perimeter edges.
Edge 4, 5, and 7 edges are on outside edges only; balance of edges are self edge.



phone: (510) 259-6217
email: info@actionlaminates.com

EDGE DETAILS

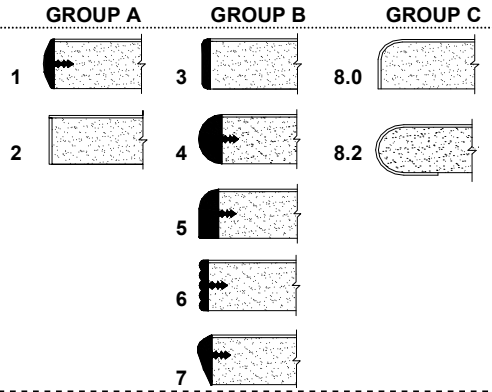

TRANSACTION COUNTER TOPS

	MODEL NUMBER	SIZE	WT.	GROUP A	GROUP B	GROUP C
EXTENDED L-SHAPED w/ RADIUS						
	26-□-12-3238-□	12 x 31.5 x 37.5	20	302	348	-
	26-□-12-3244-□	12 x 31.5 x 43.5	22	302	348	-
	26-□-12-3256-□	12 x 31.5 x 55.5	27	365	422	-
	26-□-12-3268-□	12 x 31.5 x 67.5	32	428	496	-
	26-□-12-3280-□	12 x 31.5 x 79.5	37	559	638	-
	26-□-12-3288-□	12 x 31.5 x 87.5	42	559	638	-
	26-□-12-3210-□	12 x 31.5 x 103.5	47	695	804	-
	26-□-12-3844-□	12 x 37.5 x 43.5	26	388	450	-
	26-□-12-3856-□	12 x 37.5 x 55.5	30	473	547	-
	26-□-12-3868-□	12 x 37.5 x 67.5	34	559	638	-
	26-□-12-3880-□	12 x 37.5 x 79.5	40	735	849	-
	26-□-12-3888-□	12 x 37.5 x 87.5	45	735	849	-
	26-□-12-3810-□	12 x 37.5 x 103.5	50	918	1055	-
	LEFT EXTENSION SHOWN ABOVE					
	26-□-12-4456-□	12 x 43.5 x 55.5	33	473	547	-
	26-□-12-4468-□	12 x 43.5 x 67.5	37	559	638	-
	26-□-12-4480-□	12 x 43.5 x 79.5	43	735	849	-
	26-□-12-4488-□	12 x 43.5 x 87.5	48	735	849	-
	26-□-12-4410-□	12 x 43.5 x 103.5	53	918	1055	-
	RIGHT EXTENSION SHOWN ABOVE					
	26-□-12-5668-□	12 x 55.5 x 67.5	41	690	792	-
	26-□-12-5680-□	12 x 55.5 x 79.5	47	901	1037	-
	26-□-12-5688-□	12 x 55.5 x 87.5	52	901	1037	-
	26-□-12-5610-□	12 x 55.5 x 103.5	57	1129	1294	-

OPTIONS:

Round Grommet 3" add \$ 30 List.

NOTES:

Please specify left or right extension: add "L" or "R" after "26" in model number.

Please specify edge detail at the end of the model number.

Edge 1, 2, 3 and 6 are perimeter edges.

Edge 4, 5, and 7 edges are on outside edges only; balance of edges are self edge.

EXTENDED L-SHAPED W/ RADIUS: standard with 6" radius corner.



phone: (510) 259-6217
email: info@actionlaminates.com

1/2 mm PVC

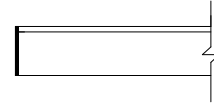

T-Mold

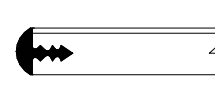

MARKER BOARDS WALL MOUNT

	MODEL NUMBER	SIZE	WT.	LIST PRICE
	28-1824- <input type="checkbox"/>	18 x 24	9	81
	28-1830- <input type="checkbox"/>	18 x 30	10	92
	28-1836- <input type="checkbox"/>	18 x 36	11	98
	28-1842- <input type="checkbox"/>	18 x 42	13	121
	28-1848- <input type="checkbox"/>	18 x 48	15	121
	28-1860- <input type="checkbox"/>	18 x 60	19	150
	28-1872- <input type="checkbox"/>	18 x 72	23	173
	28-1884- <input type="checkbox"/>	18 x 84	26	224
	28-1896- <input type="checkbox"/>	18 x 96	30	224
	<hr/>			
	28-2424- <input type="checkbox"/>	24 x 24	10	92
	28-2430- <input type="checkbox"/>	24 x 30	13	104
	28-2436- <input type="checkbox"/>	24 x 36	15	121
	28-2442- <input type="checkbox"/>	24 x 42	18	155
	28-2448- <input type="checkbox"/>	24 x 48	20	155
	28-2460- <input type="checkbox"/>	24 x 60	25	184
	28-2472- <input type="checkbox"/>	24 x 72	30	224
	28-2484- <input type="checkbox"/>	24 x 84	35	293
	28-2496- <input type="checkbox"/>	24 x 96	40	293
<hr/>				
	28-3030- <input type="checkbox"/>	30 x 30	16	127
	28-3036- <input type="checkbox"/>	30 x 36	19	150
	28-3042- <input type="checkbox"/>	30 x 42	22	184
	28-3048- <input type="checkbox"/>	30 x 48	25	184
	28-3060- <input type="checkbox"/>	30 x 60	31	230
	28-3072- <input type="checkbox"/>	30 x 72	38	276
	28-3084- <input type="checkbox"/>	30 x 84	44	357
	28-3096- <input type="checkbox"/>	30 x 96	50	357

OPTIONS:

PVC available in white or black.
T-Mold available in black only.

NOTES:

For Wall mount add - W to the end of the model number.
Standard 7/8" thick PVC or T-Mold. Please specify,
see options.
Standard metal mounting brackets included.



phone: (510) 259-6217
 email: info@actionlaminates.com

Basic Elements Table of Contents

Edge Details and Finish Specifications	41-42
Accessories	
Door and Drawer Pulls	123
Fabric Tack Boards - Wall Mount	119
Fabric Tack Boards - Hutch Mount	119
Flat Brackets, L-Brackets	122
Grommets	124
Locker Locks	105
Pencil Drawers, Keyboard Drawers	120
Task Lights	119
Wire Management	120
Worksurface Wall Brackets	121
Commercial Cabinets	
Base Cabinets	112-115
Upper Cabinets	106-111
Hutch Units	
Bookcase/hutch	90
Open Without Top	86
Open With Top	87
With Hinged Doors	88
With Lid Doors	89
Lateral Files	
Freestanding Lateral files	91
Mail Organizers	
Hutch-style	117
Wall Mount	116
Overhead Storage Modules	
Wall Mount - Open w/o Top	82
Wall Mount - Open w/ Top	83
Wall Mount - Hinged Door	84
Wall Mount - Lid Door	85
Speciality Components	
Corner Cabinets	118
Mobile Cabinets	118
Recycle Cabinets	118



phone: (510) 259-6217
 email: info@actionlaminates.com

Basic Elements Table of Contents, continued

Storage Components

Laminate Doors, Glass Doors	97-99
Open Bookcases	95-96
Storage Cabinets	101-102
Wardrobe Cabinets	100
Cubbies	103
Lockers	104

Support Panels

Corner L Supports	121
End Panels	121
Mid Supports	121
Modesty panels	122

Support & Mobile Pedestals

Floor Support BBF, FF	92
Mobile BBF, FF	92
Mobile BBB, BF	92
Mobile BF with Cushion	92
Floor Support Lateral, File Center	93
Floor Support Hinged Door Cabinets	94
Floor Support Open Cubbies	94

Workstation Components

Bridge Units	76
Bullet Units	61
Convex Units	61
Corner units	43-45
Credenza - Shell	69
Credenza - Single Pedestal	70
Credenza - Twin Pedestal	71
Credenza - Lateral File	72
Credenza - Lateral/ Pedestal	73
Credenza - Hinged Door	74-75
Credenza - Buffet	74-75
Desk - Shell	69
Desk - Single Pedestal	70
Desk - Twin Pedestal	71
Desk - Lateral File	72
Desk - Lateral/ Pedestal	73
Extended Corner Units - Bullet	63-65
Extended Corner Units - Open	46-48
Extended Corner Units - P-shape	66-68
Extended Corner Units - Single Pedestal	49-51
Extended Corner Units - Twin Pedestal	52-54
Extended Corner Units - Lateral File	55-57



phone: (510) 259-6217
email: info@actionlaminates.com

Basic Elements Table of Contents, continued

Workstation Components, Continued

Extended Corner Units - Lateral/ Pedestal	58-60
J-shape Units	62
P-shape Units	62
Returns - Open	77
Returns - Single Pedestal	78
Returns - Twin Pedestal	79
Returns - Lateral File	80
Returns - Lateral/ Pedestal	81

Add
10% effective
7/1/2024



phone: (510) 259-6217
email: info@actionlaminates.com

BASIC ELEMENTS

EDGE DETAILS AND FINISH SPECIFICATIONS

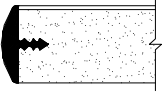
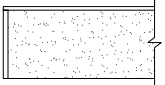
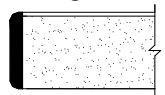
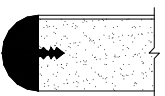
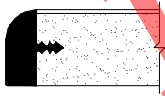
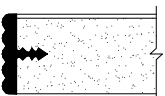
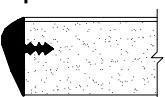
GROUP A	DESCRIPTION	STANDARD COLORS
EDGE 1	<p>T-Mold</p>  <p>Core Material: 45lb high density particle board finished with high pressure laminate top, backing sheet on the bottom.</p> <p>Edge: T-Molding 3/16" x 1 1/8"thick T-Molding 3/16" x 1 1/4"thick.</p>	<p>1 1/8" Edge: Dark Tone, Medium Tone, Light Tone, Innertone-r, Light Grey.</p> <p>1 1/4" Edge: Almond, Beige, Black, Brown, Charcoal, Clay, Dark Tone, Graphite, Greytone, Innertone Light, Innertone R, Light Grey, Light Tone, Medium Tone, Platinum, Putty, R-Beige, Sand, Smoke, Soft White, Taupe - Lt Tone, White.</p>
EDGE 2	<p>Self Edge</p>  <p>Core Material: 45lb high density particle board finished with high pressure laminate top, backing sheet on the bottom.</p> <p>Edge: High pressure laminate 1/16" x 1 1/4"thick.</p>	<p>High pressure laminate matching the top. Contrasting self edge consult factory for pricing.</p>
EDGE 3	<p>PVC Edge</p>  <p>Core Material: 45lb high density particle board finished with high pressure laminate top, backing sheet on the bottom.</p> <p>Edge: PVC 3 mm x 1 1/4"thick.</p>	<p>Antique White, Beigewood, Black, Boardwalk Oak, Cocobala, Designer White, Dove Grey, Fawn Cypress, Figured Mahogany, Fonthill Pear, Frosty White, Fusion Maple, Golden Oak, Grey 1500, Hardrock Maple, Henna Cherry, HM Innertone Light, HM Innertone-R, HM Mediumtone, HW Graphite, HW Putty, HW Smoke, Kensington Maple, Manitoba Maple, Monticello Maple, Pebble, Pepperdust, Platinum, Regency Walnut, River Cherry, Skyline Walnut, Slate, Sterling Ash, Studio Teak, Walnut Heights, Wild Cherry, Windsor Mahogany, Yorkshire Cherry, Witchcraft</p>
EDGE 4	<p>Bullnose T-mold</p>  <p>Core Material: 45lb high density particle board finished with high pressure laminate top, backing sheet on the bottom.</p> <p>Edge: Bullnose T-Molding 1/2" x 1 1/4" thick.</p>	<p>Black, Gloss Grey</p>
EDGE 5	<p>Radius T-mold</p>  <p>Core Material: 45lb high density particle board finished with high pressure laminate top, backing sheet on the bottom.</p> <p>Edge: Radius T-Molding 1/2" x 1 1/4"thick.</p>	<p>Black</p>
EDGE 6	<p>5 Bead T-mold</p>  <p>Core Material: 45lb high density particle board finished with high pressure laminate top, backing sheet on the bottom.</p> <p>Edge: T-Molding 1/4" x 1 1/4"thick.</p>	<p>Black</p>
EDGE 7	<p>Sloped T-mold</p>  <p>Core Material: 45lb high density particle board finished with high pressure laminate top, backing sheet on the bottom.</p> <p>Edge: T-Molding 3/8" x 1 1/4"thick.</p>	<p>Black</p>



Laminates: Standard matte finishes in solid, wood grain, and patterns from Wilsonart, Formica, Nevamar, and Pionite.
Premium finishes or laminates by Abet laminati, Laminart, and others are available upon request.



phone: (510) 259-6217
 email: info@actionlaminates.com

BASIC ELEMENTS

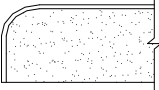
EDGE DETAILS AND FINISH SPECIFICATIONS

GROUP C	DESCRIPTION	STANDARD COLORS
EDGE 8.0	<p>Radius Post Formed Edge</p>  <p>Core Material: 45lb high density particle board finished with high pressure laminate top, backing sheet on the bottom.</p> <p>Edge: 90 degree, postformed edge 1-1/4".</p>	Continuous high pressure laminate from the top.
EDGE 8.2	<p>Bullnose Post Formed Edge</p>  <p>Core Material: 45lb high density particle board finished with high pressure laminate top, backing sheet on the bottom.</p> <p>Edge: 180 degree, postformed edge 1-1/4".</p>	Continuous high pressure laminate from the top.

Add 10% effective 7/1/2024

Laminates: Standard matte finishes in solid, wood grain, and patterns from Wilsonart, Formica, Nevamar, and Pionite.
 Premium finishes or laminates by Abet laminati, Laminart, and others are available upon request.



phone: (510) 259-6217
email: info@actionlaminates.com

EDGE DETAILS

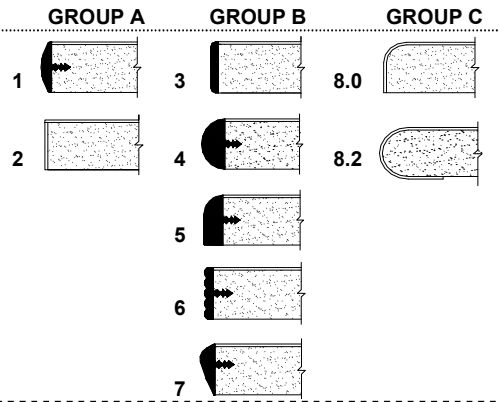

**BASIC ELEMENTS
DIAGONAL CORNER UNITS**

	MODEL NUMBER	SIZE	WT.	GROUP A	GROUP B	GROUP C
	350-36-2020- □	36 x 36 x 20 x 20	85	811	845	960
	350-36-2424- □	36 x 36 x 24 x 24	85	811	845	960
	350-36-2024- □	36 x 36 x 20 x 24	85	811	845	960
	350-36-2420- □	36 x 36 x 24 x 20	85	811	845	960
	350-42-2424- □	42 x 42 x 24 x 24	95	972	1029	1242
	350-42-3030- □	42 x 42 x 30 x 30	95	972	1029	1242
	350-42-2430- □	42 x 42 x 24 x 30	95	972	1029	1242
	350-42-3024- □	42 x 42 x 30 x 24	95	972	1029	1242
	350-48-2424- □	48 x 48 x 24 x 24	110	972	1029	1242
	350-48-3030- □	48 x 48 x 30 x 30	110	972	1029	1242
	350-48-2430- □	48 x 48 x 24 x 30	110	972	1029	1242
	350-48-3024- □	48 x 48 x 30 x 24	110	972	1029	1242
	350-60-2424- □	60 x 60 x 24 x 24	145	1179	1271	-
	350-60-3030- □	60 x 60 x 30 x 30	145	1179	1271	-
	350-60-2430- □	60 x 60 x 24 x 30	145	1179	1271	-
	350-60-3024- □	60 x 60 x 30 x 24	145	1179	1271	-

100% Effective
7/11/2024

OPTIONS:

Additional Round Grommet 3" add \$ 30 List.

NOTES:

Please specify edge detail at the end of the model number.

Standard with one 3" round grommet at the corner.



phone: (510) 259-6217
email: info@actionlaminates.com

EDGE DETAILS

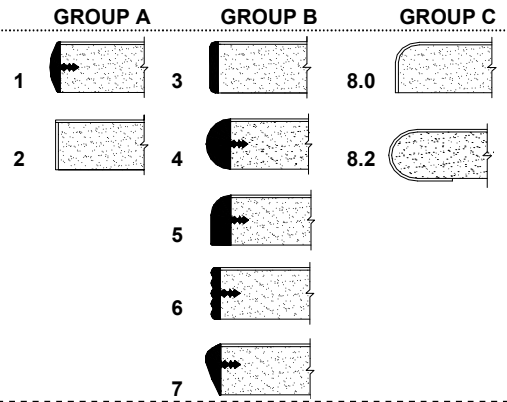

**BASIC ELEMENTS
NOTCHED CORNER UNITS**

	MODEL NUMBER	SIZE	WT.	GROUP A	GROUP B	GROUP C
	351-36-2020- □	36 x 36 x 20 x 20	85	811	845	-
	351-36-2424- □	36 x 36 x 24 x 24	85	811	845	-
	351-36-2024- □	36 x 36 x 20 x 24	85	811	845	-
	351-36-2420- □	36 x 36 x 24 x 20	85	811	845	-
	351-42-2424- □	42 x 42 x 24 x 24	95	972	1029	-
	351-42-3030- □	42 x 42 x 30 x 30	95	972	1029	-
	351-42-2430- □	42 x 42 x 24 x 30	95	972	1029	-
	351-42-3024- □	42 x 42 x 30 x 24	95	972	1029	-
	351-48-2424- □	48 x 48 x 24 x 24	110	972	1029	-
	351-48-3030- □	48 x 48 x 30 x 30	110	972	1029	-
	351-48-2430- □	48 x 48 x 24 x 30	110	972	1029	-
	351-48-3024- □	48 x 48 x 30 x 24	110	972	1029	-
	351-60-2424- □	60 x 60 x 24 x 24	145	1179	1271	-
	351-60-3030- □	60 x 60 x 30 x 30	145	1179	1271	-
	351-60-2430- □	60 x 60 x 24 x 30	145	1179	1271	-
	351-60-3024- □	60 x 60 x 30 x 24	145	1179	1271	-

100% Effective 7/1/2024

OPTIONS:

Additional Round Grommet 3" add \$ 30 List.

NOTES:

Please specify edge detail at the end of the model number.

Standard with one 3" round grommet at the corner.



phone: (510) 259-6217
email: info@actionlaminates.com

EDGE DETAILS

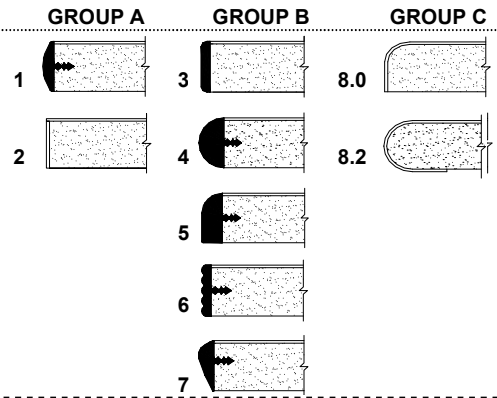

**BASIC ELEMENTS
CURVED CORNER UNITS**

	MODEL NUMBER	SIZE	WT.	GROUP A	GROUP B	GROUP C
	352-36-2020- <input type="checkbox"/>	36 x 36 x 20 x 20	85	811	845	-
	352-36-2424- <input type="checkbox"/>	36 x 36 x 24 x 24	85	811	845	-
	352-36-2024- <input type="checkbox"/>	36 x 36 x 20 x 24	85	811	845	-
	352-36-2420- <input type="checkbox"/>	36 x 36 x 24 x 20	85	811	845	-
	352-42-2424- <input type="checkbox"/>	42 x 42 x 24 x 24	95	972	1029	-
	352-42-3030- <input type="checkbox"/>	42 x 42 x 30 x 30	95	972	1029	-
	352-42-2430- <input type="checkbox"/>	42 x 42 x 24 x 30	95	972	1029	-
	352-42-3024- <input type="checkbox"/>	42 x 42 x 30 x 24	95	972	1029	-
	352-48-2424- <input type="checkbox"/>	48 x 48 x 24 x 24	110	972	1029	-
	352-48-3030- <input type="checkbox"/>	48 x 48 x 30 x 30	110	972	1029	-
	352-48-2430- <input type="checkbox"/>	48 x 48 x 24 x 30	110	972	1029	-
	352-48-3024- <input type="checkbox"/>	48 x 48 x 30 x 24	110	972	1029	-
	352-60-2424- <input type="checkbox"/>	60 x 60 x 24 x 24	145	1179	1271	-
	352-60-3030- <input type="checkbox"/>	60 x 60 x 30 x 30	145	1179	1271	-
	352-60-2430- <input type="checkbox"/>	60 x 60 x 24 x 30	145	1179	1271	-
	352-60-3024- <input type="checkbox"/>	60 x 60 x 30 x 24	145	1179	1271	-

100% Effective 7/11/2024

OPTIONS:

Additional Round Grommet 3" add \$ 30 List.

NOTES:

Please specify edge detail at the end of the model number.

Standard with one 3" round grommet at the corner.



phone: (510) 259-6217
email: info@actionlaminates.com

EDGE DETAILS

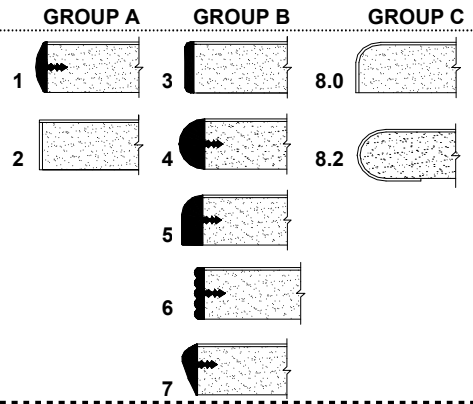

**BASIC ELEMENTS
EXTENDED DIAGONAL CORNER UNITS**

	MODEL NUMBER	SIZE	WT.	GROUP A	GROUP B	GROUP C
	353-□3648-2020- □	36 x 48 x 20 x 20	110	949	989	-
	353-□3648-2424- □	36 x 48 x 24 x 24	110	949	989	-
	353-□3648-2024- □	36 x 48 x 20 x 24	110	949	989	-
	353-□3648-2420- □	36 x 48 x 24 x 20	110	949	989	-
	353-□3660-2020- □	36 x 60 x 20 x 20	120	1012	1070	-
	353-□3660-2424- □	36 x 60 x 24 x 24	120	1012	1070	-
	353-□3660-2024- □	36 x 60 x 20 x 24	120	1012	1070	-
	353-□3660-2420- □	36 x 60 x 24 x 20	120	1012	1070	-
	353-□3672-2020- □	36 x 72 x 20 x 20	140	1231	1300	-
	353-□3672-2424- □	36 x 72 x 24 x 24	140	1231	1300	-
	353-□3672-2024- □	36 x 72 x 20 x 24	140	1231	1300	-
	353-□3672-2420- □	36 x 72 x 24 x 20	140	1231	1300	-
<p>Left Extension Shown</p>	353-□3696-2020- □	36 x 96 x 20 x 20	160	1374	1466	-
	353-□3696-2424- □	36 x 96 x 24 x 24	160	1374	1466	-
	353-□3696-2024- □	36 x 96 x 20 x 24	160	1374	1466	-
	353-□3696-2420- □	36 x 96 x 24 x 20	160	1374	1466	-
	353-□4860-2424- □	48 x 60 x 24 x 24	130	1133	1202	-
	353-□4860-3030- □	48 x 60 x 30 x 30	130	1133	1202	-
	353-□4860-2430- □	48 x 60 x 24 x 30	130	1133	1202	-
	353-□4860-3024- □	48 x 60 x 30 x 24	130	1133	1202	-
	353-□4872-2424- □	48 x 72 x 24 x 24	150	1374	1466	-
	353-□4872-3030- □	48 x 72 x 30 x 30	150	1374	1466	-
	353-□4872-2430- □	48 x 72 x 24 x 30	150	1374	1466	-
	353-□4872-3024- □	48 x 72 x 30 x 24	150	1374	1466	-
<p>Right Extension Shown</p>	353-□4896-2424- □	48 x 96 x 24 x 24	165	1564	1673	-
	353-□4896-3030- □	48 x 96 x 30 x 30	165	1564	1673	-
	353-□4896-2430- □	48 x 96 x 24 x 30	165	1564	1673	-
	353-□4896-3024- □	48 x 96 x 30 x 24	165	1564	1673	-

OPTIONS:

Additional Round Grommet 3" add \$ 30 List.

NOTES:

Standard with one 3" round grommet at the corner.
Please specify left or right extension: add "L" or "R" after "353" in model number
Please specify edge detail at end of model number.
Edge 1, 2, 3 and 6 are perimeter edges.
Edge 4, 5, and 7 are on front (user) edge only; balance of edges are self edge.
Units less than 72" wide do not require mid support panel.



phone: (510) 259-6217
email: info@actionlaminates.com

EDGE DETAILS

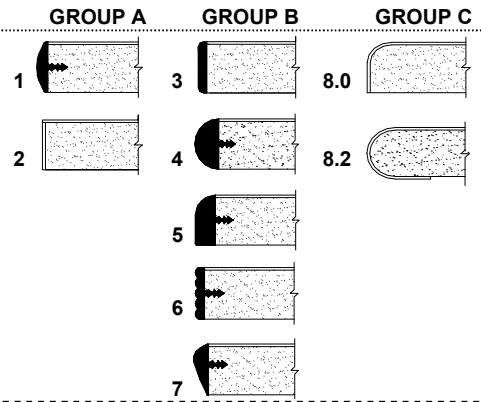

**BASIC ELEMENTS
EXTENDED NOTCHED CORNER UNITS**

	MODEL NUMBER	SIZE	WT.	GROUP A	GROUP B	GROUP C
	354-□4860-2424- □	48 x 60 x 24 x 24	130	1133	1202	-
	354-□4860-3030- □	48 x 60 x 30 x 30	130	1133	1202	-
	354-□4860-2430- □	48 x 60 x 24 x 30	130	1133	1202	-
	354-□4860-3024- □	48 x 60 x 30 x 24	130	1133	1202	-
	354-□4872-2424- □	48 x 72 x 24 x 24	150	1374	1466	-
	354-□4872-3030- □	48 x 72 x 30 x 30	150	1374	1466	-
	354-□4872-2430- □	48 x 72 x 24 x 30	150	1374	1466	-
	354-□4872-3024- □	48 x 72 x 30 x 24	150	1374	1466	-
	354-□4896-2424- □	48 x 96 x 24 x 24	165	1564	1673	-
	354-□4896-3030- □	48 x 96 x 30 x 30	165	1564	1673	-
	354-□4896-2430- □	48 x 96 x 24 x 30	165	1564	1673	-
	354-□4896-3024- □	48 x 96 x 30 x 24	165	1564	1673	-
Left Extension Shown						
	354-□6072-2424- □	60 x 72 x 24 x 24	160	1507	1622	-
	354-□6072-3030- □	60 x 72 x 30 x 30	160	1507	1622	-
	354-□6072-2430- □	60 x 72 x 24 x 30	160	1507	1622	-
	354-□6072-3024- □	60 x 72 x 30 x 24	160	1507	1622	-
	354-□6084-2424- □	60 x 84 x 24 x 24	180	1742	1892	-
	354-□6084-3030- □	60 x 84 x 30 x 30	180	1742	1892	-
	354-□6084-2430- □	60 x 84 x 24 x 30	180	1742	1892	-
	354-□6084-3024- □	60 x 84 x 30 x 24	180	1742	1892	-
	354-□6096-2424- □	60 x 96 x 24 x 24	190	1742	1892	-
	354-□6096-3030- □	60 x 96 x 30 x 30	190	1742	1892	-
	354-□6096-2430- □	60 x 96 x 24 x 30	190	1742	1892	-
	354-□6096-3024- □	60 x 96 x 30 x 24	190	1742	1892	-

Right Extension Shown

OPTIONS:

Additional Round Grommet 3" add \$ 30 List.

NOTES:

Standard with one 3" round grommet at the corner.
Please specify left or right extension: add "L" or "R" after "354" in model number
Please specify edge detail at end of model number.
Edge 1, 2, 3 and 6 are perimeter edges.
Edge 4, 5, and 7 are on front (user) edge only; balance of edges are self edge.
Units less than 72" wide do not require mid support panel.



phone: (510) 259-6217
email: info@actionlaminates.com

EDGE DETAILS

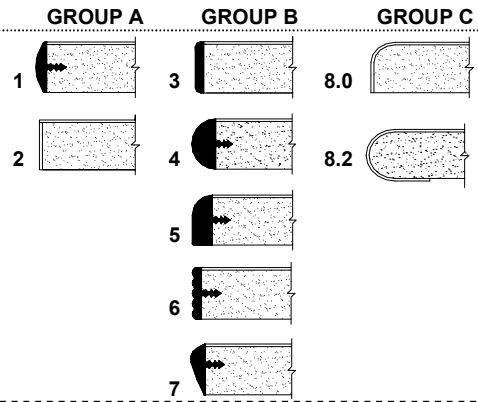

**BASIC ELEMENTS
EXTENDED CURVED CORNER UNITS**

	MODEL NUMBER	SIZE	WT.	GROUP A	GROUP B	GROUP C
	355-□3648-2020- □	36 x 48 x 20 x 20	110	949	989	-
	355-□3648-2424- □	36 x 48 x 24 x 24	110	949	989	-
	355-□3648-2024 □	36 x 48 x 20 x 24	110	949	989	-
	355-□3648-2420- □	36 x 48 x 24 x 20	110	949	989	-
	355-□3660-2020- □	36 x 60 x 20 x 20	120	1012	1070	-
	355-□3660-2424- □	36 x 60 x 24 x 24	120	1012	1070	-
	355-□3660-2024 □	36 x 60 x 20 x 24	120	1012	1070	-
	355-□3660-2420- □	36 x 60 x 24 x 20	120	1012	1070	-
	355-□3672-2020- □	36 x 72 x 20 x 20	140	1231	1300	-
	355-□3672-2424- □	36 x 72 x 24 x 24	140	1231	1300	-
	355-□3672-2024 □	36 x 72 x 20 x 24	140	1231	1300	-
	355-□3672-2420- □	36 x 72 x 24 x 20	140	1231	1300	-
Left Extension Shown	355-□3696-2020- □	36 x 96 x 20 x 20	160	1374	1466	-
	355-□3696-2424- □	36 x 96 x 24 x 24	160	1374	1466	-
	355-□3696-2024 □	36 x 96 x 20 x 24	160	1374	1466	-
	355-□3696-2420- □	36 x 96 x 24 x 20	160	1374	1466	-
	355-□4860-2424- □	48 x 60 x 24 x 24	130	1133	1202	-
	355-□4860-3030- □	48 x 60 x 30 x 30	130	1133	1202	-
	355-□4860-2430- □	48 x 60 x 24 x 30	130	1133	1202	-
	355-□4860-3024- □	48 x 60 x 30 x 24	130	1133	1202	-
	355-□4872-2424- □	48 x 72 x 24 x 24	150	1374	1466	-
	355-□4872-3030- □	48 x 72 x 30 x 30	150	1374	1466	-
	355-□4872-2430- □	48 x 72 x 24 x 30	150	1374	1466	-
	355-□4872-3024- □	48 x 72 x 30 x 24	150	1374	1466	-
Right Extension Shown	355-□4896-2424- □	48 x 96 x 24 x 24	165	1564	1673	-
	355-□4896-3030- □	48 x 96 x 30 x 30	165	1564	1673	-
	355-□4896-2430- □	48 x 96 x 24 x 30	165	1564	1673	-
	355-□4896-3024- □	48 x 96 x 30 x 24	165	1564	1673	-

OPTIONS:

Additional Round Grommet 3" add \$ 30 List.

NOTES:

Standard with one 3" round grommet at the corner.
Please specify left or right extension: add "L" or "R" after "355" in model number
Please specify edge detail at end of model number.
Edge 1, 2, 3 and 6 are perimeter edges.
Edge 4, 5, and 7 are on front (user) edge only; balance of edges are self edge.
Units less than 72" wide do not require mid support panel.



phone: (510) 259-6217
email: info@actionlaminates.com

EDGE DETAILS

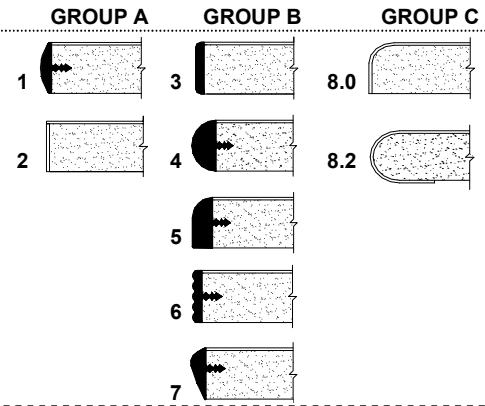

BASIC ELEMENTS
EXTENDED DIAGONAL CORNER UNITS
W/ PEDESTAL

	MODEL NUMBER	SIZE	WT.	GROUP A	GROUP B	GROUP C
	356-□-3660-2020- □	36 x 60 x 20 x 20	190	1645	1702	-
	356-□-3660-2424- □	36 x 60 x 24 x 24	190	1645	1702	-
	356-□-3660-2024- □	36 x 60 x 20 x 24	190	1645	1702	-
	356-□-3660-2420- □	36 x 60 x 24 x 20	190	1645	1702	-
	356-□-3672-2020- □	36 x 72 x 20 x 20	200	1714	1771	-
	356-□-3672-2424- □	36 x 72 x 24 x 24	200	1714	1771	-
	356-□-3672-2024- □	36 x 72 x 20 x 24	200	1714	1771	-
	356-□-3672-2420- □	36 x 72 x 24 x 20	200	1714	1771	-
	356-□-3696-2020- □	36 x 96 x 20 x 20	220	1995	2087	-
	356-□-3696-2424- □	36 x 96 x 24 x 24	220	1995	2087	-
	356-□-3696-2024- □	36 x 96 x 20 x 24	220	1995	2087	-
	356-□-3696-2420- □	36 x 96 x 24 x 20	220	1995	2087	-
Left Extension Shown						
	356-□-4860-2424- □	48 x 60 x 24 x 24	200	1753	1834	-
	356-□-4860-3030- □	48 x 60 x 30 x 30	200	1753	1834	-
	356-□-4860-2430- □	48 x 60 x 24 x 30	200	1753	1834	-
	356-□-4860-3024- □	48 x 60 x 30 x 24	200	1753	1834	-
	356-□-4872-2424- □	48 x 72 x 24 x 24	220	1846	1938	-
	356-□-4872-3030- □	48 x 72 x 30 x 30	220	1846	1938	-
	356-□-4872-2430- □	48 x 72 x 24 x 30	220	1846	1938	-
	356-□-4872-3024- □	48 x 72 x 30 x 24	200	1846	1938	-
	356-□-4896-2424- □	48 x 96 x 24 x 24	240	2185	2294	-
	356-□-4896-3030- □	48 x 96 x 30 x 30	240	2185	2294	-
	356-□-4896-2430- □	48 x 96 x 24 x 30	240	2185	2294	-
	356-□-4896-3024- □	48 x 96 x 30 x 24	240	2185	2294	-
Right Extension Shown						

OPTIONS:

Additional Round Grommet 3" add \$ 30 List.
Substitute laminate F/F pedestal in place of B/B/F pedestal: N/C

NOTES:

Standard with one 3" round grommet at the corner.
Please specify left or right extension: add "L" or "R" after "356" in model number
Please specify edge detail at end of model number.
Edge 1, 2, 3 and 6 are perimeter edges.
Edge 4, 5, and 7 are on front (user) edge only;
balance of edges are self edge.
Units 96"w include one additional center mid support.
Standard laminate B/B/F pedestal includes lock.



phone: (510) 259-6217
email: info@actionlaminates.com

EDGE DETAILS

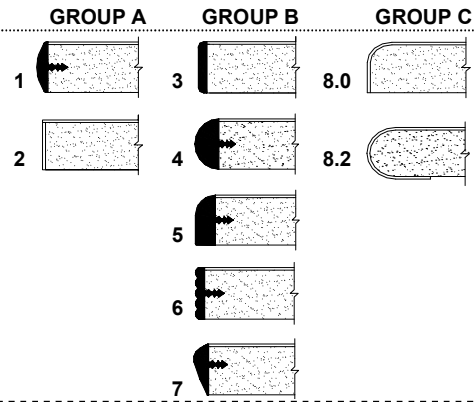

**BASIC ELEMENTS
EXTENDED NOTCHED CORNER UNITS
W/ PEDESTAL**

	MODEL NUMBER	SIZE	WT.	GROUP A	GROUP B	GROUP C
	357-□-4860-2424-□	48 x 60 x 24 x 24	200	1753	1834	-
	357-□-4860-3030-□	48 x 60 x 30 x 30	200	1753	1834	-
	357-□-4860-2430-□	48 x 60 x 24 x 30	200	1753	1834	-
	357-□-4860-3024-□	48 x 60 x 30 x 24	200	1753	1834	-
	357-□-4872-2424-□	48 x 72 x 24 x 24	220	1846	1938	-
	357-□-4872-3030-□	48 x 72 x 30 x 30	220	1846	1938	-
	357-□-4872-2430-□	48 x 72 x 24 x 30	220	1846	1938	-
	357-□-4872-3024-□	48 x 72 x 30 x 24	220	1846	1938	-
	357-□-4896-2424-□	48 x 96 x 24 x 24	240	2185	2294	-
	357-□-4896-3030-□	48 x 96 x 30 x 30	240	2185	2294	-
	357-□-4896-2430-□	48 x 96 x 24 x 30	240	2185	2294	-
	357-□-4896-3024-□	48 x 96 x 30 x 24	240	2185	2294	-
Left Extension Shown Above						
	357-□-6072-2424-□	60 x 72 x 24 x 24	230	1990	2093	-
	357-□-6072-3030-□	60 x 72 x 30 x 30	230	1990	2093	-
	357-□-6072-2430-□	60 x 72 x 24 x 30	230	1990	2093	-
	357-□-6072-3024-□	60 x 72 x 30 x 24	230	1990	2093	-
	357-□-6084-2424-□	60 x 84 x 24 x 24	250	2369	2513	-
	357-□-6084-3030-□	60 x 84 x 30 x 30	250	2369	2513	-
	357-□-6084-2430-□	60 x 84 x 24 x 30	250	2369	2513	-
	357-□-6084-3024-□	60 x 84 x 30 x 24	250	2369	2513	-
	357-□-6096-2424-□	60 x 96 x 24 x 24	260	2369	2513	-
	357-□-6096-3030-□	60 x 96 x 30 x 30	260	2369	2513	-
	357-□-6096-2430-□	60 x 96 x 24 x 30	260	2369	2513	-
	357-□-6096-3024-□	60 x 96 x 30 x 24	260	2369	2513	-

Right Extension Shown Above

OPTIONS:

Additional Round Grommet 3" add \$ 30 List.
Substitute laminate F/F pedestal in place of B/B/F pedestal: N/C

NOTES:

Standard with one 3" round grommet at the corner.
Please specify left or right extension: add "L" or "R" after "357" in model number
Please specify edge detail at end of model number.
Edge 1, 2, 3 and 6 are perimeter edges.
Edge 4, 5, and 7 are on front (user) edge only; balance of edges are self edge.
Units 96"w include one additional center mid support.
Standard laminate B/B/F pedestal includes lock.



phone: (510) 259-6217
email: info@actionlaminates.com

EDGE DETAILS

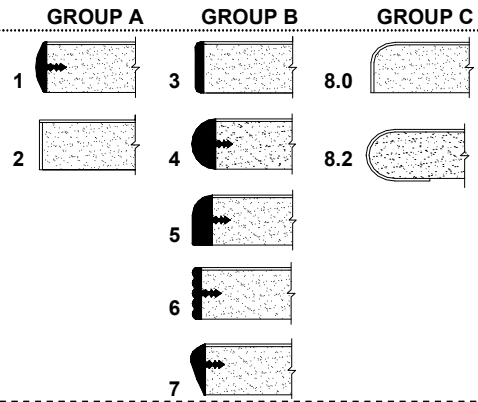

**BASIC ELEMENTS
EXTENDED CURVED CORNER UNITS
W/ PEDESTAL**

	MODEL NUMBER	SIZE	WT.	GROUP A	GROUP B	GROUP C
	358-□3660-2020- □	36 x 60 x 20 x 20	190	1645	1702	-
	358-□3660-2424- □	36 x 60 x 24 x 24	190	1645	1702	-
	358-□3660-2024- □	36 x 60 x 20 x 24	190	1645	1702	-
	358-□3660-2420- □	36 x 60 x 24 x 20	190	1645	1702	-
	358-□3672-2020- □	36 x 72 x 20 x 20	200	1714	1771	-
	358-□3672-2424 □	36 x 72 x 24 x 24	200	1714	1771	-
	358-□3672-2024- □	36 x 72 x 20 x 24	200	1714	1771	-
	358-□3672-2420- □	36 x 72 x 24 x 20	200	1714	1771	-
	358-□3696-2020- □	36 x 96 x 20 x 20	220	1995	2087	-
	358-□3696-2424- □	36 x 96 x 24 x 24	220	1995	2087	-
	358-□3696-2024- □	36 x 96 x 20 x 24	220	1995	2087	-
	358-□3696-2420- □	36 x 96 x 24 x 20	220	1995	2087	-
	358-□4860-2424- □	48 x 60 x 24 x 24	200	1753	1834	-
	358-□4860-3030- □	48 x 60 x 30 x 30	200	1753	1834	-
	358-□4860-2430- □	48 x 60 x 24 x 30	200	1753	1834	-
	358-□4860-3024- □	48 x 60 x 30 x 24	200	1753	1834	-
	358-□4872-2424- □	48 x 72 x 24 x 24	220	1846	1938	-
	358-□4872-3030- □	48 x 72 x 30 x 30	220	1846	1938	-
	358-□4872-2430- □	48 x 72 x 24 x 30	220	1846	1938	-
	358-□4872-3024- □	48 x 72 x 30 x 24	220	1846	1938	-
	358-□4896-2424- □	48 x 96 x 24 x 24	240	2185	2294	-
	358-□4896-3030- □	48 x 96 x 30 x 30	240	2185	2294	-
	358-□4896-2430- □	48 x 96 x 24 x 30	240	2185	2294	-
	358-□4896-3024- □	48 x 96 x 30 x 24	240	2185	2294	-

Left Extension Shown Above

Right Extension Shown Above

OPTIONS:

Additional Round Grommet 3" add \$ 30 List.
Substitute laminate F/F pedestal in place of B/B/F pedestal: N/C

NOTES:

Standard with one 3" round grommet at the corner.
Please specify left or right extension: add "L" or "R" after "358" in model number
Please specify edge detail at end of model number.
Edge 1, 2, 3 and 6 are perimeter edges.
Edge 4, 5, and 7 are on front (user) edge only; balance of edges are self edge.
Units 96"w include one additional center mid support.
Standard laminate B/B/F pedestal includes lock.



phone: (510) 259-6217
email: info@actionlaminates.com

EDGE DETAILS

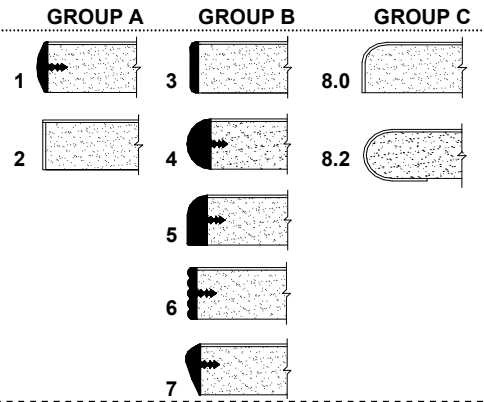

**BASIC ELEMENTS
EXTENDED DIAGONAL CORNER UNITS
W/ DOUBLE PEDESTALS**

	MODEL NUMBER	SIZE	WT.	GROUP A	GROUP B	GROUP C
	359-□3672-2020- □	36 x 72 x 20 x 20	275	2547	2616	-
	359-□3672-2424- □	36 x 72 x 24 x 24	275	2547	2616	-
	359-□3672-2024- □	36 x 72 x 20 x 24	275	2547	2616	-
	359-□3672-2420- □	36 x 72 x 24 x 20	275	2547	2616	-
	359-□3684-2020- □	36 x 84 x 20 x 20	285	2691	2777	-
	359-□3684-2424- □	36 x 84 x 24 x 24	285	2691	2777	-
	359-□3684-2024- □	36 x 84 x 20 x 24	285	2691	2777	-
	359-□3684-2420- □	36 x 84 x 24 x 20	285	2691	2777	-
<p>Left Extension Shown Above</p>	359-□3696-2020- □	36 x 96 x 20 x 20	305	2691	2777	-
	359-□3696-2424- □	36 x 96 x 24 x 24	305	2691	2777	-
	359-□3696-2024- □	36 x 96 x 20 x 24	305	2691	2777	-
	359-□3696-2420- □	36 x 96 x 24 x 20	305	2691	2777	-
<p>Right Extension Shown Above</p>	359-□4884-2424- □	48 x 84 x 24 x 24	310	2869	2990	-
	359-□4884-3030- □	48 x 84 x 30 x 30	310	2869	2990	-
	359-□4884-2430- □	48 x 84 x 24 x 30	310	2869	2990	-
	359-□4884-3024- □	48 x 84 x 30 x 24	310	2869	2990	-
	359-□4896-2424- □	48 x 96 x 24 x 24	320	2869	2990	-
	359-□4896-3030- □	48 x 96 x 30 x 30	320	2869	2990	-
	359-□4896-2430- □	48 x 96 x 24 x 30	320	2869	2990	-
	359-□4896-3024- □	48 x 96 x 30 x 24	320	2869	2990	-

OPTIONS:

Additional Round Grommet 3" add \$ 30 List.

NOTES:

Standard with one 3" round grommet at the corner.
Please specify left or right extension: add "L" or "R" after "359" in model number
Please specify edge detail at end of model number.
Edge 1, 2, 3 and 6 are perimeter edges.
Edge 4, 5, and 7 are on front (user) edge only; balance of edges are self edge.
Standard laminate pedestal includes lock.
Standard pedestal configuration is as shown, to interchange please specify.



phone: (510) 259-6217
email: info@actionlaminates.com

EDGE DETAILS

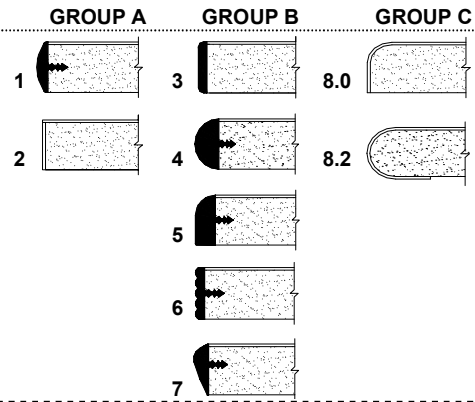

**BASIC ELEMENTS
EXTENDED NOTCHED CORNER UNITS
W/ DOUBLE PEDESTALS**

	MODEL NUMBER	SIZE	WT.	GROUP A	GROUP B	GROUP C
	360-□4884-2424- □	48 x 84 x 24 x 24	310	2869	2984	-
	360-□4884-3030- □	48 x 84 x 30 x 30	310	2869	2984	-
	360-□4884-2430- □	48 x 84 x 24 x 30	310	2869	2984	-
	360-□4884-3024- □	48 x 84 x 30 x 24	310	2869	2984	-
	360-□4896-2424- □	48 x 96 x 24 x 24	320	2869	2984	-
	360-□4896-3030- □	48 x 96 x 30 x 30	320	2869	2984	-
	360-□4896-2430- □	48 x 96 x 24 x 30	320	2869	2984	-
	360-□4896-3024- □	48 x 96 x 30 x 24	320	2869	2984	-
<p>Left Extension Shown Above</p>	360-□6084-2424- □	60 x 84 x 24 x 24	335	3053	3191	-
	360-□6084-3030- □	60 x 84 x 30 x 30	335	3053	3191	-
	360-□6084-2430- □	60 x 84 x 24 x 30	335	3053	3191	-
	360-□6084-3024- □	60 x 84 x 30 x 24	335	3053	3191	-
<p>Right Extension Shown Above</p>	360-□6096-2424- □	60 x 96 x 24 x 24	345	3053	3191	-
	360-□6096-3030- □	60 x 96 x 30 x 30	345	3053	3191	-
	360-□6096-2430- □	60 x 96 x 24 x 30	345	3053	3191	-
	360-□6096-3024- □	60 x 96 x 30 x 24	345	3053	3191	-

OPTIONS:

Additional Round Grommet 3" add \$ 30 List.

NOTES:

Standard with one 3" round grommet at the corner.
Please specify left or right extension: add "L" or "R" after "360" in model number
Please specify edge detail at end of model number.
Edge 1, 2, 3 and 6 are perimeter edges.
Edge 4, 5, and 7 are on front (user) edge only; balance of edges are self edge.
Standard laminate pedestal includes lock.
Standard pedestal configuration is as shown, to interchange please specify.



phone: (510) 259-6217
email: info@actionlaminates.com

EDGE DETAILS

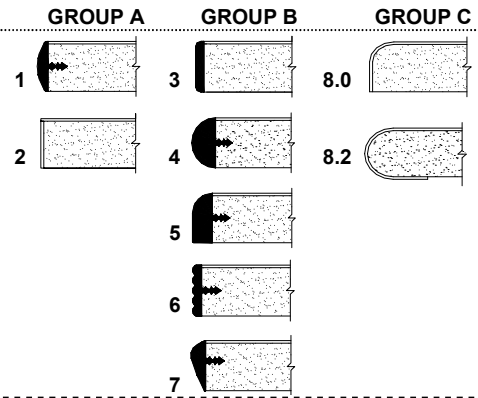

**BASIC ELEMENTS
EXTENDED CURVED CORNER UNITS
W/ DOUBLE PEDESTALS**

	MODEL NUMBER	SIZE	WT.	GROUP A	GROUP B	GROUP C
	361-□-3672-2020-□	36 x 72 x 20 x 20	275	2547	2616	-
	361-□-3672-2424-□	36 x 72 x 24 x 24	275	2547	2616	-
	361-□-3672-2024-□	36 x 72 x 20 x 24	275	2547	2616	-
	361-□-3672-2420-□	36 x 72 x 24 x 20	275	2547	2616	-
	361-□-3684-2020-□	36 x 84 x 20 x 20	285	2691	2777	-
	361-□-3684-2424-□	36 x 84 x 24 x 24	285	2691	2777	-
	361-□-3684-2024-□	36 x 84 x 20 x 24	285	2691	2777	-
	361-□-3684-2420-□	36 x 84 x 24 x 20	285	2691	2777	-
	361-□-3696-2020-□	36 x 96 x 20 x 20	305	2691	2777	-
	361-□-3696-2424-□	36 x 96 x 24 x 24	305	2691	2777	-
	361-□-3696-2024-□	36 x 96 x 20 x 24	305	2691	2777	-
	361-□-3696-2420-□	36 x 96 x 24 x 20	305	2691	2777	-
Left Extension Shown Above						
	361-□-4884-2424-□	48 x 84 x 24 x 24	310	2869	2984	-
	361-□-4884-3030-□	48 x 84 x 30 x 30	310	2869	2984	-
	361-□-4884-2430-□	48 x 84 x 24 x 30	310	2869	2984	-
	361-□-4884-3024-□	48 x 84 x 30 x 24	310	2869	2984	-
	361-□-4896-2424-□	48 x 96 x 24 x 24	320	2869	2984	-
	361-□-4896-3030-□	48 x 96 x 30 x 30	320	2869	2984	-
	361-□-4896-2430-□	48 x 96 x 24 x 30	320	2869	2984	-
	361-□-4896-3024-□	48 x 96 x 30 x 24	320	2869	2984	-
Right Extension Shown Above						

OPTIONS:

Additional Round Grommet 3" add \$ 30 List.

NOTES:

Standard with one 3" round grommet at the corner.
Please specify left or right extension: add "L" or "R" after "361" in model number
Please specify edge detail at end of model number.
Edge 1, 2, 3 and 6 are perimeter edges.
Edge 4, 5, and 7 are on front (user) edge only;
balance of edges are self edge.
Standard laminate pedestal includes lock.
Standard pedestal configuration is as shown,
to interchange please specify.



phone: (510) 259-6217
email: info@actionlaminates.com

EDGE DETAILS

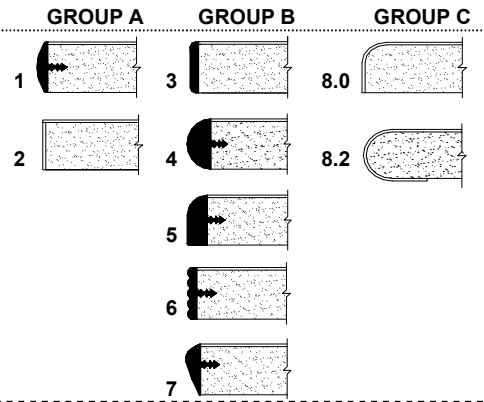

**BASIC ELEMENTS
EXTENDED DIAGONAL CORNER UNITS
W/ LATERAL FILE**

	MODEL NUMBER	SIZE	WT.	GROUP A	GROUP B	GROUP C
	362-□-3672-2020-□	36 x 72 x 20 x 20	230	2162	2220	-
	362-□-3672-2424-□	36 x 72 x 24 x 24	230	2162	2220	-
	362-□-3672-2024-□	36 x 72 x 20 x 24	230	2162	2220	-
	362-□-3672-2420-□	36 x 72 x 24 x 20	230	2162	2220	-
	362-□-3684-2020-□	36 x 84 x 20 x 20	240	2294	2386	-
	362-□-3684-2424-□	36 x 84 x 24 x 24	240	2294	2386	-
	362-□-3684-2024-□	36 x 84 x 20 x 24	240	2294	2386	-
	362-□-3684-2420-□	36 x 84 x 24 x 20	240	2294	2386	-
	362-□-3696-2020-□	36 x 96 x 20 x 20	260	2294	2386	-
	362-□-3696-2424-□	36 x 96 x 24 x 24	260	2294	2386	-
	362-□-3696-2024-□	36 x 96 x 20 x 24	260	2294	2386	-
	362-□-3696-2420-□	36 x 96 x 24 x 20	260	2294	2386	-
Left Extension Shown Above						
	362-□-4884-2424-□	48 x 84 x 24 x 24	265	2484	2599	-
	362-□-4884-3030-□	48 x 84 x 30 x 30	265	2484	2599	-
	362-□-4884-2430-□	48 x 84 x 24 x 30	265	2484	2599	-
	362-□-4884-3024-□	48 x 84 x 30 x 24	265	2484	2599	-
	362-□-4896-2424-□	48 x 96 x 24 x 24	275	2484	2599	-
	362-□-4896-3030-□	48 x 96 x 30 x 30	275	2484	2599	-
	362-□-4896-2430-□	48 x 96 x 24 x 30	275	2484	2599	-
	362-□-4896-3024-□	48 x 96 x 30 x 24	275	2484	2599	-
Right Extension Shown Above						

OPTIONS:

Additional Round Grommet 3" Add \$ 30 List

NOTES:

Standard with one 3" round grommet at the corner.
Please specify left or right extension: add "L" or "R" after "362" in model number
Please specify edge detail at end of model number.
Edge 1, 2, 3 and 6 are perimeter edges.
Edge 4, 5, and 7 are on front (user) edge only; balance of edges are self edge.
Standard laminate lateral file is 18"D x 30" wide, includes lock.



phone: (510) 259-6217
email: info@actionlaminates.com

EDGE DETAILS

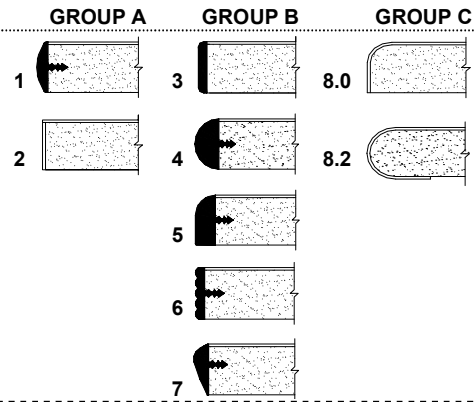

**BASIC ELEMENTS
EXTENDED NOTCHED CORNER UNITS
W/ LATERAL FILE**

	MODEL NUMBER	SIZE	WT.	GROUP A	GROUP B	GROUP C
	363-□-4884-2424-□	48 x 84 x 24 x 24	265	2484	2599	-
	363-□-4884-3030-□	48 x 84 x 30 x 30	265	2484	2599	-
	363-□-4884-2430-□	48 x 84 x 24 x 30	265	2484	2599	-
	363-□-4884-3024-□	48 x 84 x 30 x 24	265	2484	2599	-
	363-□-4896-2424-□	48 x 96 x 24 x 24	275	2484	2599	-
	363-□-4896-3030-□	48 x 96 x 30 x 30	275	2484	2599	-
	363-□-4896-2430-□	48 x 96 x 24 x 30	275	2484	2599	-
	363-□-4896-3024-□	48 x 96 x 30 x 24	275	2484	2599	-
<p>Left Extension Shown Above</p>	363-□-6084-2424-□	60 x 84 x 24 x 24	290	2668	2812	-
	363-□-6084-3030-□	60 x 84 x 30 x 30	290	2668	2812	-
	363-□-6084-2430-□	60 x 84 x 24 x 30	290	2668	2812	-
	363-□-6084-3024-□	60 x 84 x 30 x 24	290	2668	2812	-
<p>Right Extension Shown Above</p>	363-□-6096-2424-□	60 x 96 x 24 x 24	300	2668	2812	-
	363-□-6096-3030-□	60 x 96 x 30 x 30	300	2668	2812	-
	363-□-6096-2430-□	60 x 96 x 24 x 30	300	2668	2812	-
	363-□-6096-3024-□	60 x 96 x 30 x 24	300	2668	2812	-

OPTIONS:

Additional Round Grommet 3" add \$ 30 List.

NOTES:

Standard with one 3" round grommet at the corner.
Please specify left or right extension: add "L" or "R" after "63" in model number
Please specify edge detail at end of model number.
Edge 1, 2, 3 and 6 are perimeter edges.
Edge 4, 5, and 7 are on front (user) edge only; balance of edges are self edge.
Standard laminate lateral file is 18"D x 30" wide, includes lock.



phone: (510) 259-6217
email: info@actionlaminates.com

EDGE DETAILS

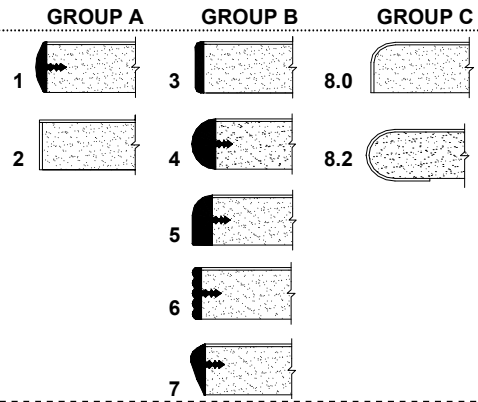

**BASIC ELEMENTS
EXTENDED CURVED CORNER UNITS
W/ LATERAL FILE**

	MODEL NUMBER	SIZE	WT.	GROUP A	GROUP B	GROUP C
	364-□-3672-2020-□	36 x 72 x 20 x 20	230	2162	2220	-
	364-□-3672-2424-□	36 x 72 x 24 x 24	230	2162	2220	-
	364-□-3672-2024-□	36 x 72 x 20 x 24	230	2162	2220	-
	364-□-3672-2420-□	36 x 72 x 24 x 20	230	2162	2220	-
	364-□-3684-2020-□	36 x 84 x 20 x 20	240	2294	2386	-
	364-□-3684-2424-□	36 x 84 x 24 x 24	240	2294	2386	-
	364-□-3684-2024-□	36 x 84 x 20 x 24	240	2294	2386	-
	364-□-3684-2420-□	36 x 84 x 24 x 20	240	2294	2386	-
	364-□-3696-2020-□	36 x 96 x 20 x 20	260	2294	2386	-
	364-□-3696-2424-□	36 x 96 x 24 x 24	260	2294	2386	-
	364-□-3696-2024-□	36 x 96 x 20 x 24	260	2294	2386	-
	364-□-3696-2420-□	36 x 96 x 24 x 20	260	2294	2386	-
Left Extension Shown Above						
	364-□-4884-2424-□	48 x 84 x 24 x 24	265	2484	2599	-
	364-□-4884-3030-□	48 x 84 x 30 x 30	265	2484	2599	-
	364-□-4884-2430-□	48 x 84 x 24 x 30	265	2484	2599	-
	364-□-4884-3024-□	48 x 84 x 30 x 24	265	2484	2599	-
	364-□-4896-2424-□	48 x 96 x 24 x 24	275	2484	2599	-
	364-□-4896-3030-□	48 x 96 x 30 x 30	275	2484	2599	-
	364-□-4896-2430-□	48 x 96 x 24 x 30	275	2484	2599	-
	364-□-4896-3024-□	48 x 96 x 30 x 24	275	2484	2599	-
Right Extension Shown Above						

OPTIONS:

Additional Round Grommet 3" add \$ 30 List.

NOTES:

Standard with one 3" round grommet at the corner.
Please specify left or right extension: add "L" or "R" after "364" in model number
Please specify edge detail at end of model number.
Edge 1, 2, 3 and 6 are perimeter edges.
Edge 4, 5, and 7 are on front (user) edge only; balance of edges are self edge.
Standard laminate lateral file is 18"D x 30" wide, includes lock.



phone: (510) 259-6217
email: info@actionlaminates.com

EDGE DETAILS

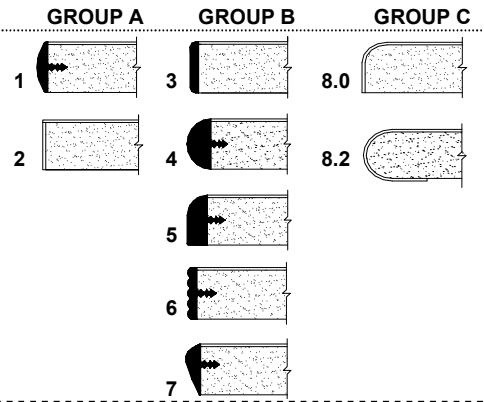

**BASIC ELEMENTS
EXTENDED DIAGONAL CORNER UNITS
W/ LATERAL FILE AND PEDESTAL**

	MODEL NUMBER	SIZE	WT.	GROUP A	GROUP B	GROUP C
	365-□3684-2020- □	36 x 84 x 20 x 20	335	3140	3226	-
	365-□3684-2424- □	36 x 84 x 24 x 24	335	3140	3226	-
	365-□3684-2024- □	36 x 84 x 20 x 24	335	3140	3226	-
	365-□3684-2420- □	36 x 84 x 24 x 20	335	3140	3226	-
	365-□3696-2020- □	36 x 96 x 20 x 20	355	3140	3226	-
	365-□3696-2424- □	36 x 96 x 24 x 24	355	3140	3226	-
	365-□3696-2024- □	36 x 96 x 20 x 24	355	3140	3226	-
	365-□3696-2420- □	36 x 96 x 24 x 20	355	3140	3226	-
Left Extension Shown Above						
	365-□4896-2424- □	48 x 96 x 24 x 24	370	3324	3439	-
	365-□4896-3030- □	48 x 96 x 30 x 30	370	3324	3439	-
	365-□4896-2430- □	48 x 96 x 24 x 30	370	3324	3439	-
	365-□4896-3024- □	48 x 96 x 30 x 24	370	3324	3439	-
Right Extension Shown Above						

Add effective 10% 7/1/2024

OPTIONS:

Additional Round Grommet 3" add \$ 30 List.
Substitute laminate F/F pedestal in place of B/B/F pedestal: N/C

NOTES:

Standard with one 3" round grommet at the corner.
Please specify left or right extension: add "L" or "R" after "365" in model number
Please specify edge detail at end of model number.
Edge 1, 2, 3 and 6 are perimeter edges.
Edge 4, 5, and 7 are on front (user) edge only; balance of edges are self edge.
Standard laminate lateral file is 18"D x 30" wide, includes lock.
Standard pedestal configuration as shown.



phone: (510) 259-6217
email: info@actionlaminates.com

EDGE DETAILS

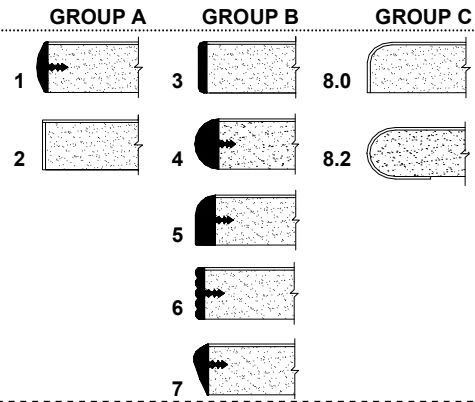

**BASIC ELEMENTS
EXTENDED NOTCHED CORNER UNITS
W/ LATERAL FILE AND PEDESTAL**

	MODEL NUMBER	SIZE	WT.	GROUP A	GROUP B	GROUP C
	366-□3684-2020-□	36 x 84 x 20 x 20	335	3140	3226	-
	366-□3684-2424-□	36 x 84 x 24 x 24	335	3140	3226	-
	366-□3684-2024-□	36 x 84 x 20 x 24	335	3140	3226	-
	366-□3684-2420-□	36 x 84 x 24 x 20	335	3140	3226	-
	366-□3696-2020-□	36 x 96 x 20 x 20	355	3140	3226	-
	366-□3696-2424-□	36 x 96 x 24 x 24	355	3140	3226	-
	366-□3696-2024-□	36 x 96 x 20 x 24	355	3140	3226	-
	366-□3696-2420-□	36 x 96 x 24 x 20	355	3140	3226	-
Left Extension Shown Above						
	366-□4896-2424-□	48 x 96 x 24 x 24	370	3324	3439	-
	366-□4896-3030-□	48 x 96 x 30 x 30	370	3324	3439	-
	366-□4896-2430-□	48 x 96 x 24 x 30	370	3324	3439	-
	366-□4896-3024-□	48 x 96 x 30 x 24	370	3324	3439	-
Right Extension Shown Above						

Add effective 10% 7/11/2024

OPTIONS:

Additional Round Grommet 3" add \$ 30 List.
Substitute laminate F/F pedestal in place of B/B/F pedestal: N/C

NOTES:

Standard with one 3" round grommet at the corner.
Please specify left or right extension: add "L" or "R" after "366" in model number
Please specify edge detail at end of model number.
Edge 1, 2, 3 and 6 are perimeter edges.
Edge 4, 5, and 7 are on front (user) edge only; balance of edges are self edge.
Standard laminate lateral file is 18"D x 30" wide, includes lock.
Standard pedestal configuration as shown.



phone: (510) 259-6217
email: info@actionlaminates.com

EDGE DETAILS

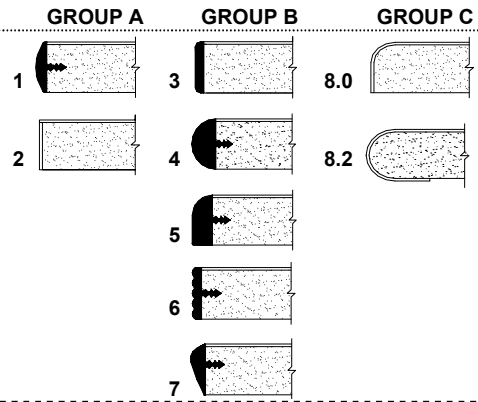

**BASIC ELEMENTS
EXTENDED CURVED CORNER UNITS
W/ LATERAL FILE AND PEDESTAL**

	MODEL NUMBER	SIZE	WT.	GROUP A	GROUP B	GROUP C
	367-□3684-2020-□	36 x 84 x 20 x 20	335	3140	3226	-
	367-□3684-2424-□	36 x 84 x 24 x 24	335	3140	3226	-
	367-□3684-2024-□	36 x 84 x 20 x 24	335	3140	3226	-
	367-□3684-2420-□	36 x 84 x 24 x 20	335	3140	3226	-
	367-□3696-2020-□	36 x 96 x 20 x 20	355	3140	3226	-
	367-□3696-2424-□	36 x 96 x 24 x 24	355	3140	3226	-
	367-□3696-2024-□	36 x 96 x 20 x 24	355	3140	3226	-
	367-□3696-2420-□	36 x 96 x 24 x 20	355	3140	3226	-
Left Extension Shown Above						
	367-□4896-2424-□	48 x 96 x 24 x 24	370	3324	3439	-
	367-□4896-3030-□	48 x 96 x 30 x 30	370	3324	3439	-
	367-□4896-2430-□	48 x 96 x 24 x 30	370	3324	3439	-
	367-□4896-3024-□	48 x 96 x 30 x 24	370	3324	3439	-
Right Extension Shown Above						

Add effective 10% 7/1/2024

OPTIONS:

Additional Round Grommet 3" add \$ 30 List.
Substitute laminate F/F pedestal in place of B/B/F pedestal: N/C

NOTES:

Standard with one 3" round grommet at the corner.
Please specify left or right extension: add "L" or "R" after "367" in model number
Please specify edge detail at end of model number.
Edge 1, 2, 3 and 6 are perimeter edges.
Edge 4, 5, and 7 are on front (user) edge only; balance of edges are self edge.
Standard laminate lateral file is 18"D x 30" wide, includes lock.
Standard pedestal configuration as shown.



phone: (510) 259-6217
email: info@actionlaminates.com

EDGE DETAILS

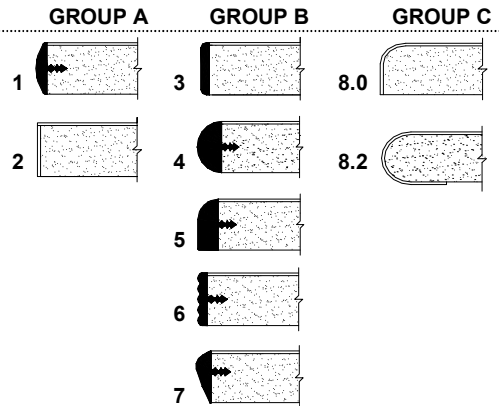

**BASIC ELEMENTS
PENINSULA UNITS**

	MODEL NUMBE	SIZE	WT.	GROUP A	GROUP B	GROUP C
BULLET SHAPE						
	368-2460- □	24 x 60	73	679	725	-
	368-2472- □	24 x 72	82	725	771	-
	368-2484- □	24 x 84	92	799	868	-
	368-2496- □	24 x 96	101	799	868	-
	368-3060- □	30 x 60	89	771	822	-
	368-3072- □	30 x 72	100	822	880	-
	368-3084- □	30 x 84	112	926	995	-
	368-3096- □	30 x 96	123	926	995	-
	368-3660- □	36 x 60	104	886	955	-
	368-3672- □	36 x 72	118	955	1024	-
	368-3684- □	36 x 84	132	1081	1167	-
	368-3696- □	36 x 96	145	1081	1167	-
CONVEX SHAPE						
	369-2460- □	24 x 60	73	679	725	828
	369-2472- □	24 x 72	82	725	771	886
	369-2484- □	24 x 84	92	799	868	1006
	369-2496- □	24 x 96	101	799	868	1006
	369-3060- □	30 x 60	89	771	822	943
	369-3072- □	30 x 72	100	822	880	1018
	369-3084- □	30 x 84	112	926	995	1173
	369-3096- □	30 x 96	123	926	995	1173
	369-3660- □	36 x 60	104	886	955	1093
	369-3672- □	36 x 72	118	955	1024	1190
	369-3684- □	36 x 84	132	1081	1167	1386
	369-3696- □	36 x 96	145	1081	1167	1386

OPTIONS:

Round Grommet 3" add \$ 30 List.
To up-grade to a 4" base add \$ 60 List.
To up-grade to a 6" base add \$ 135 List.

NOTES:

Please specify edge detail at the end of the model number.
Edge 1, 2, 3 and 6 are perimeter edges.
Edge 4, 5, 7, 8.0, and 8.2 are on front and rear edges only; balance of edges are self edge.
Standard 3" black column base.
Standard 6" mid-support panel.



phone: (510) 259-6217
email: info@actionlaminates.com

EDGE DETAILS

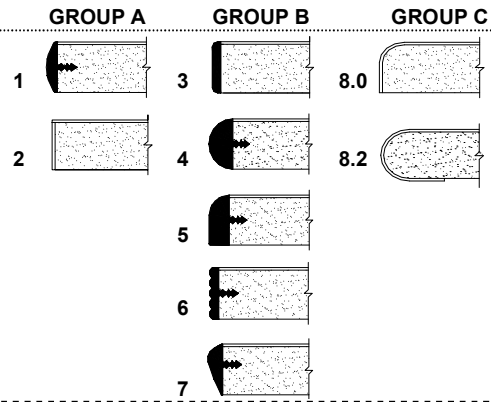

**BASIC ELEMENTS
PENINSULA UNITS**

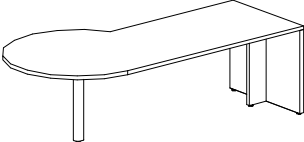
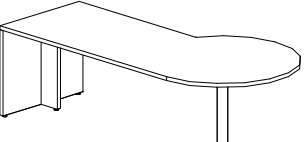
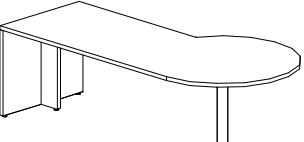
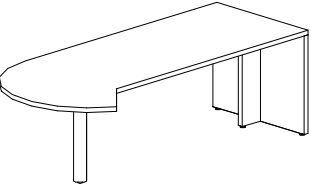
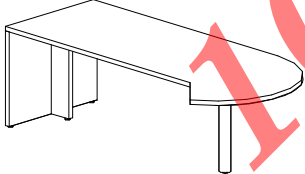
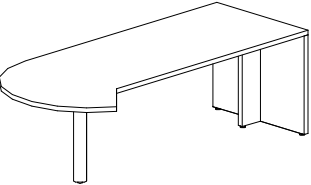
	MODEL NUMBER	SIZE	WT.	GROUP A	GROUP B	GROUP C
P SHAPE						
		D, DIA. x W				
 Left Extension Shown Above	370-□2472-□	24, 36 x 72	108	943	1018	-
	370-□2484-□	24, 36 x 84	122	1075	1173	-
	370-□2496-□	24, 36 x 96	135	1075	1173	-
 Right Extension Shown Above	370-□3072-□	30, 42 x 72	126	1116	1208	-
	370-□3084-□	30, 42 x 84	141	1305	1426	-
	370-□3096-□	30, 42 x 96	157	1305	1426	-
 Left Extension Shown Above	370-□3672-□	36, 48 x 72	143	1167	1259	-
	370-□3684-□	36, 48 x 84	161	1357	1484	-
	370-□3696-□	36, 48 x 96	179	1357	1484	-
J SHAPE						
		D, DIA. x W				
 Left Extension Shown Above	371-□-2472-□	24, 36 x 72	108	943	1018	-
	371-□-2484-□	24, 36 x 84	122	1075	1173	-
	371-□-2496-□	24, 36 x 96	135	1075	1173	-
 Right Extension Shown Above	371-□-3072-□	30, 42 x 72	126	1116	1208	-
	371-□-3084-□	30, 42 x 84	141	1305	1426	-
	371-□-3096-□	30, 42 x 96	157	1305	1426	-
 Left Extension Shown Above	371-□-3672-□	36, 48 x 72	143	1167	1259	-
	371-□-3684-□	36, 48 x 84	161	1357	1484	-
	371-□-3696-□	36, 48 x 96	179	1357	1484	-

OPTIONS:

Round Grommet 3" add \$ 30 List.
To up-grade to a 6" base add \$ 80 List.

NOTES:

Please specify left or right extension: add "L" or "R" after "370" or "371" in model number.
Please specify edge detail at the end of the model number.
Edge 1, 2, 3 and 6 are perimeter edges.
Edge 4, 5, and 7 are on front (user) edge only; balance of edges are self edge.
Standard 4" black column base.



phone: (510) 259-6217
email: info@actionlaminates.com

BASIC ELEMENTS

EXTENDED DIAGONAL CORNER

BULLET UNITS

EDGE DETAILS

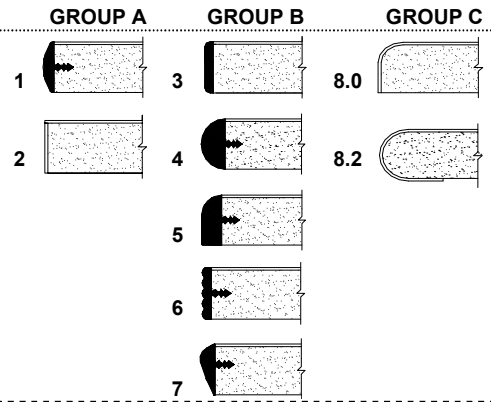

	MODEL NUMBER	SIZE	WT.	GROUP A	GROUP B	GROUP C
	372-□-3660-2020-□	36 x 60 x 20 x 20	98	937	1001	-
	372-□-3660-2424-□	36 x 60 x 24 x 24	98	937	1001	-
	372-□-3660-2024-□	36 x 60 x 20 x 24	98	937	1001	-
	372-□-3660-2420-□	36 x 60 x 24 x 20	98	937	1001	-
	372-□-3672-2020-□	36 x 72 x 20 x 20	107	1001	1081	-
	372-□-3672-2424-□	36 x 72 x 24 x 24	107	1001	1081	-
	372-□-3672-2024-□	36 x 72 x 20 x 24	107	1001	1081	-
	372-□-3672-2420-□	36 x 72 x 24 x 20	107	1001	1081	-
	372-□-3696-2020-□	36 x 96 x 20 x 20	125	1139	1236	-
	372-□-3696-2424-□	36 x 96 x 24 x 24	125	1139	1236	-
	372-□-3696-2024-□	36 x 96 x 20 x 24	125	1139	1236	-
	372-□-3696-2420-□	36 x 96 x 24 x 20	125	1139	1236	-
Left Extension Shown Above						
	372-□-4860-2424-□	48 x 60 x 24 x 24	116	1150	1231	-
	372-□-4860-3030-□	48 x 60 x 30 x 30	116	1150	1231	-
	372-□-4860-2430-□	48 x 60 x 24 x 30	116	1150	1231	-
	372-□-4860-3024-□	48 x 60 x 30 x 24	116	1150	1231	-
	372-□-4872-2424-□	48 x 72 x 24 x 24	125	1236	1334	-
	372-□-4872-3030-□	48 x 72 x 30 x 30	125	1236	1334	-
	372-□-4872-2430-□	48 x 72 x 24 x 30	125	1236	1334	-
	372-□-4872-3024-□	48 x 72 x 30 x 24	125	1236	1334	-
	372-□-4896-2424-□	48 x 96 x 24 x 24	143	1420	1553	-
	372-□-4896-3030-□	48 x 96 x 30 x 30	143	1420	1553	-
	372-□-4896-2430-□	48 x 96 x 24 x 30	143	1420	1553	-
	372-□-4896-3024-□	48 x 96 x 30 x 24	143	1420	1553	-
Right Extension Shown Above						

OPTIONS:

- Additional Round Grommet 3" add \$ 30 List.
- To up-grade to a 4" base add \$ 60 List.
- To up-grade to a 6" base add \$ 135 List.

NOTES:

- Please specify left or right extension: add "L" or "R" after "372" in model number
- Please specify edge detail at the end of the model number.
- Edge 1, 2, 3 and 6 are perimeter edges.
- Edge 4, 5, and 7 are on front (user) edge only; balance of edges are self edge.
- Standard with one 3" grommet at the corner.
- Standard 3" black column base.



phone: (510) 259-6217
email: info@actionlaminates.com

EDGE DETAILS

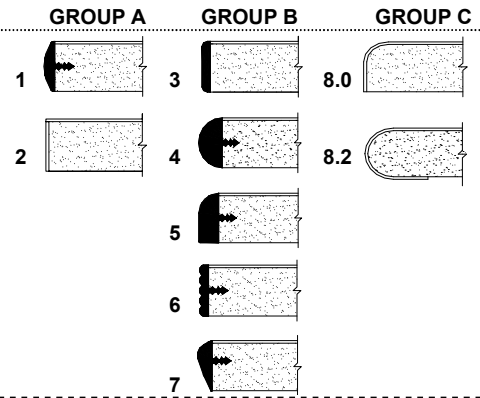

**BASIC ELEMENTS
EXTENDED NOTCHED CORNER
BULLET UNITS**

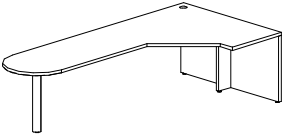
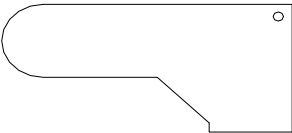
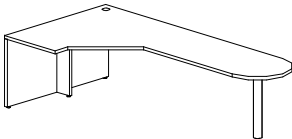
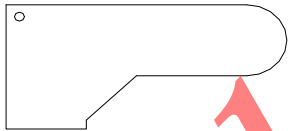
	MODEL NUMBER	SIZE	WT.	GROUP A	GROUP B	GROUP C
	373-□-4872-2424-□	48 x 72 x 24 x 24	125	1236	1334	-
	373-□-4872-3030-□	48 x 72 x 30 x 30	125	1236	1334	-
	373-□-4872-2430-□	48 x 72 x 24 x 30	125	1236	1334	-
	373-□-4872-3024-□	48 x 72 x 30 x 24	125	1236	1334	-
	373-□-4896-2424-□	48 x 96 x 24 x 24	143	1420	1553	-
	373-□-4896-3030-□	48 x 96 x 30 x 30	143	1420	1553	-
	373-□-4896-2430-□	48 x 96 x 24 x 30	143	1420	1553	-
	373-□-4896-3024-□	48 x 96 x 30 x 24	143	1420	1553	-
<p>Left Extension Shown Above</p> 	373-□-6072-2424-□	60 x 72 x 24 x 24	166	1478	1599	-
	373-□-6072-3030-□	60 x 72 x 30 x 30	166	1478	1599	-
	373-□-6072-2430-□	60 x 72 x 24 x 30	166	1478	1599	-
	373-□-6072-3024-□	60 x 72 x 30 x 24	166	1478	1599	-
<p>Right Extension Shown Above</p> 	373-□-6096-2424-□	60 x 96 x 24 x 24	188	1708	1863	-
	373-□-6096-3030-□	60 x 96 x 30 x 30	188	1708	1863	-
	373-□-6096-2430-□	60 x 96 x 24 x 30	188	1708	1863	-
	373-□-6096-3024-□	60 x 96 x 30 x 24	188	1708	1863	-

OPTIONS:

- Additional Round Grommet 3" add \$ 30 List.
- To up-grade to a 4" base add \$ 60 List.
- To up-grade to a 6" base add \$ 135 List.

NOTES:

- Please specify left or right extension: add "L" or "R" after "373" in model number
- Please specify edge detail at the end of the model number.
- Edge 1, 2, 3 and 6 are perimeter edges.
- Edge 4, 5, and 7 are on front (user) edge only; balance of edges are self edge.
- Standard with one 3" grommet at the corner.
- Standard 3" black column base.



phone: (510) 259-6217
email: info@actionlaminates.com

BASIC ELEMENTS EXTENDED CURVED CORNER BULLET UNITS

EDGE DETAILS

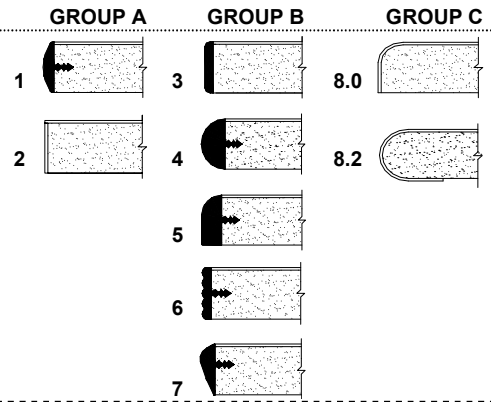

	MODEL NUMBER	SIZE	WT.	GROUP A	GROUP B	GROUP C
	374-□-3660-2020-□	36 x 60 x 20 x 20	98	937	1001	-
	374-□-3660-2424-□	36 x 60 x 24 x 24	98	937	1001	-
	374-□-3660-2024-□	36 x 60 x 20 x 24	98	937	1001	-
	374-□-3660-2420-□	36 x 60 x 24 x 20	98	937	1001	-
	374-□-3672-2020-□	36 x 72 x 20 x 20	107	1001	1081	-
	374-□-3672-2424-□	36 x 72 x 24 x 24	107	1001	1081	-
	374-□-3672-2024-□	36 x 72 x 20 x 24	107	1001	1081	-
	374-□-3672-2420-□	36 x 72 x 24 x 20	107	1001	1081	-
	374-□-3696-2020-□	36 x 96 x 20 x 20	125	1139	1236	-
	374-□-3696-2424-□	36 x 96 x 24 x 24	125	1139	1236	-
	374-□-3696-2024-□	36 x 96 x 20 x 24	125	1139	1236	-
	374-□-3696-2420-□	36 x 96 x 24 x 20	125	1139	1236	-
Left Extension Shown Above						
	374-□-4860-2424-□	48 x 60 x 24 x 24	116	1150	1231	-
	374-□-4860-3030-□	48 x 60 x 30 x 30	116	1150	1231	-
	374-□-4860-2430-□	48 x 60 x 24 x 30	116	1150	1231	-
	374-□-4860-3024-□	48 x 60 x 30 x 24	116	1150	1231	-
	374-□-4872-2424-□	48 x 72 x 24 x 24	125	1236	1334	-
	374-□-4872-3030-□	48 x 72 x 30 x 30	125	1236	1334	-
	374-□-4872-2430-□	48 x 72 x 24 x 30	125	1236	1334	-
	374-□-4872-3024-□	48 x 72 x 30 x 24	125	1236	1334	-
	374-□-4896-2424-□	48 x 96 x 24 x 24	143	1420	1553	-
	374-□-4896-3030-□	48 x 96 x 30 x 30	143	1420	1553	-
	374-□-4896-2430-□	48 x 96 x 24 x 30	143	1420	1553	-
	374-□-4896-3024-□	48 x 96 x 30 x 24	143	1420	1553	-

Right Extension Shown Above

OPTIONS:

- Additional Round Grommet 3" add \$ 30 List.
- To up-grade to a 4" base add \$ 60 List.
- To up-grade to a 6" base add \$ 135 List.

NOTES:

- Please specify left or right extension: add "L" or "R" after "374" in model number.
- Please specify edge detail at the end of the model number.
- Edge 1, 2, 3 and 6 are perimeter edges.
- Edge 4, 5, and 7 are on front (user) edge only; balance of edges are self edge.
- Standard with one 3" grommet at the corner.
- Standard 3" black column base.



phone: (510) 259-6217
email: info@actionlaminates.com

EDGE DETAILS

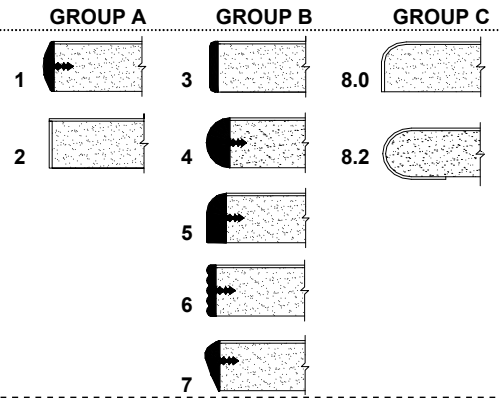

**BASIC ELEMENTS
EXTENDED DIAGONAL CORNER P UNITS**

MODEL NUMBER	SIZE	WT.	GROUP A	GROUP B	GROUP C
A X B X C X D X E					
375-□3672-2424-36- □	36 x 72 x 24 x 24 x 36	116	1202	1305	-
375-□3684-2424-36- □	36 x 84 x 24 x 24 x 36	131	1386	1512	-
375-□3696-2424-36- □	36 x 96 x 24 x 24 x 36	144	1386	1512	-
375-□4272-2424-36- □	42 x 72 x 24 x 24 x 36	136	1438	1558	-
375-□4272-3024-36- □	42 x 72 x 30 x 24 x 36	136	1438	1558	-
375-□4296-2424-36- □	42 x 96 x 24 x 24 x 36	136	1668	1823	-
375-□4296-3024-36- □	42 x 96 x 30 x 24 x 36	136	1668	1823	-
375-□4284-2424-42- □	42 x 84 x 24 x 24 x 42	151	1668	1823	-
375-□4284-3030-42- □	42 x 84 x 30 x 30 x 42	151	1668	1823	-
375-□4296-2424-42- □	42 x 96 x 24 x 24 x 42	167	1668	1823	-
375-□4296-3030-42- □	42 x 96 x 30 x 30 x 42	167	1668	1823	-
375-□4896-3030-42- □	48 x 96 x 30 x 30 x 42	185	1668	1823	-

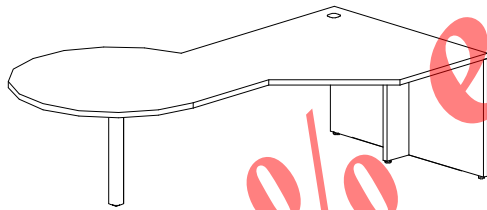

Left Extension Shown

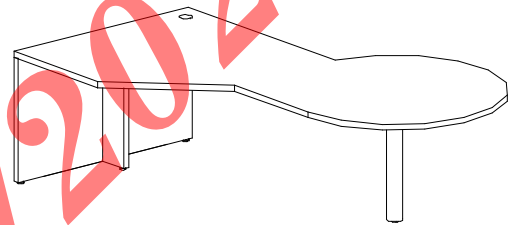

Right Extension Shown

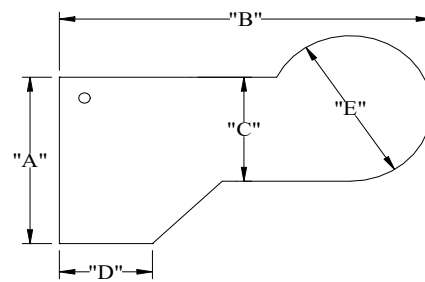
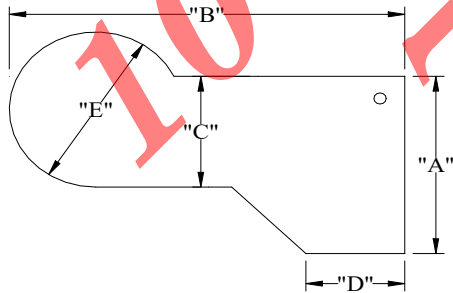

OPTIONS:

Additional Round Grommet 3" add \$ 30 List.
To up-grade to a 6" base add \$80 List.

NOTES:

Please specify left or right extension: add "L" or "R" after "375" in model number.
Please specify edge detail at the end of the model number.
Edge 1, 2, 3 and 6 are perimeter edges.
Edge 4, 5, and 7 are on front (user) edge only;
balance of edges are self edge.
Standard 4" black column base.



phone: (510) 259-6217
email: info@actionlaminates.com

EDGE DETAILS

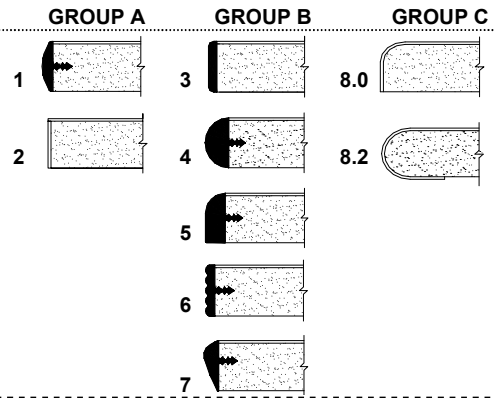

**BASIC ELEMENTS
EXTENDED NOTCHED CORNER P UNITS**

MODEL NUMBER	SIZE	WT.	GROUP A	GROUP B	GROUP C
A X B X C X D X E					
376-□3672-2424-36- □	36 x 72 x 24 x 24 x 36	116	1202	1305	-
376-□3684-2424-36- □	36 x 84 x 24 x 24 x 36	131	1386	1512	-
376-□3696-2424-36- □	36 x 96 x 24 x 24 x 36	144	1386	1512	-
376-□4272-2424-36- □	42 x 72 x 24 x 24 x 36	136	1438	1558	-
376-□4272-3024-36- □	42 x 72 x 30 x 24 x 36	136	1438	1558	-
376-□4296-2424-36- □	42 x 96 x 24 x 24 x 36	136	1668	1823	-
376-□4296-3024-36- □	42 x 96 x 30 x 24 x 36	136	1668	1823	-
376-□4284-2424-42- □	42 x 84 x 24 x 24 x 42	151	1668	1823	-
376-□4284-3030-42- □	42 x 84 x 30 x 30 x 42	151	1668	1823	-
376-□4296-2424-42- □	42 x 96 x 24 x 24 x 42	167	1668	1823	-
376-□4296-3030-42- □	42 x 96 x 30 x 30 x 42	167	1668	1823	-
376-□4896-3030-42- □	48 x 96 x 30 x 30 x 42	185	1668	1823	-

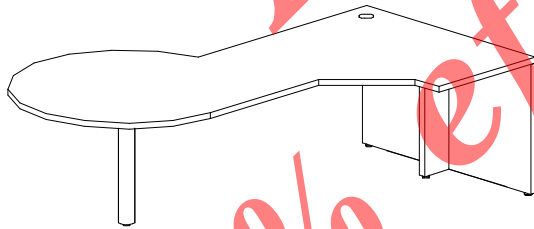

Left Extension Shown

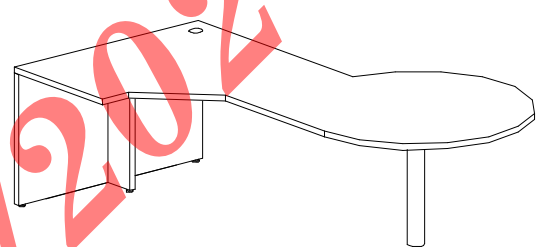

Right Extension Shown

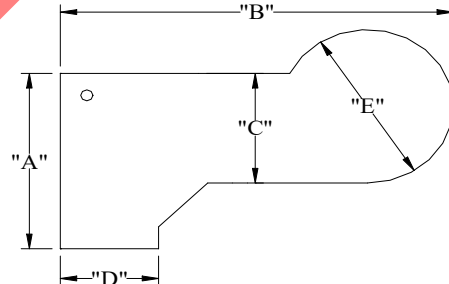
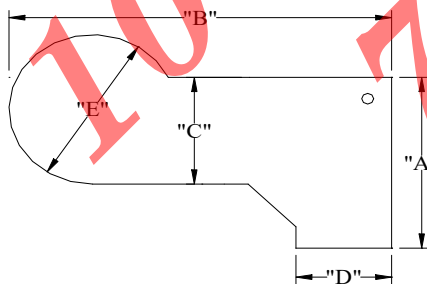

OPTIONS:

Additional Round Grommet 3" add \$ 30 List.
To up-grade to a 6" base add \$80 List.

NOTES:

Please specify left or right extension: add "L" or "R" after "376" in model number.
Please specify edge detail at the end of the model number.
Edge 1, 2, 3 and 6 are perimeter edges.
Edge 4, 5, and 7 are on front (user) edge only; balance of edges are self edge.
Standard 4" black column base.



phone: (510) 259-6217
email: info@actionlaminates.com

EDGE DETAILS

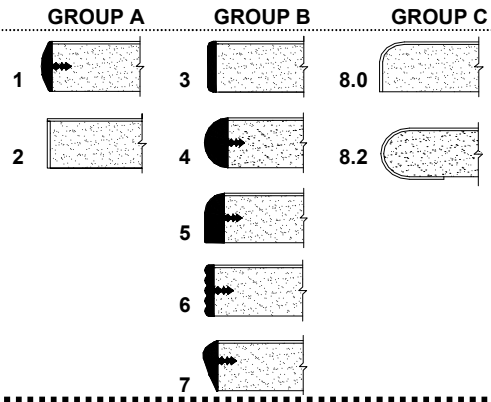

**BASIC ELEMENTS
EXTENDED CURVED CORNER P UNITS**

MODEL NUMBER	SIZE	WT.	GROUP A	GROUP B	GROUP C
A X B X C X D X E					
377-□3672-2424-36- □	36 x 72 x 24 x 24 x 36	116	1202	1305	-
377-□3684-2424-36- □	36 x 84 x 24 x 24 x 36	131	1386	1512	-
377-□3696-2424-36- □	36 x 96 x 24 x 24 x 36	144	1386	1512	-
377-□4272-2424-36- □	42 x 72 x 24 x 24 x 36	136	1438	1558	-
377-□4272-3024-36- □	42 x 72 x 30 x 24 x 36	136	1438	1558	-
377-□4296-2424-36- □	42 x 96 x 24 x 24 x 36	136	1668	1823	-
377-□4296-3024-36- □	42 x 96 x 30 x 24 x 36	136	1668	1823	-
377-□4284-2424-42- □	42 x 84 x 24 x 24 x 42	151	1668	1823	-
377-□4284-3030-42- □	42 x 84 x 30 x 30 x 42	151	1668	1823	-
377-□4296-2424-42- □	42 x 96 x 24 x 24 x 42	167	1668	1823	-
377-□4296-3030-42- □	42 x 96 x 30 x 30 x 42	167	1668	1823	-
377-□4896-3030-42- □	48 x 96 x 30 x 30 x 42	185	1668	1823	-

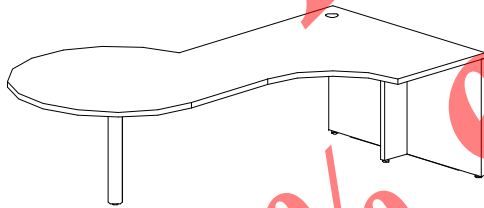

Left Extension Shown

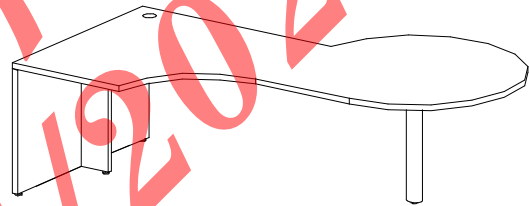

Right Extension Shown

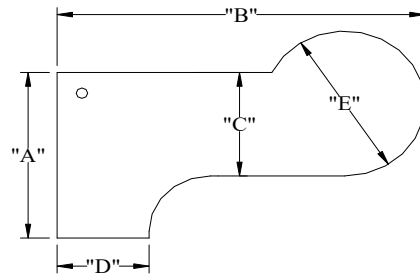
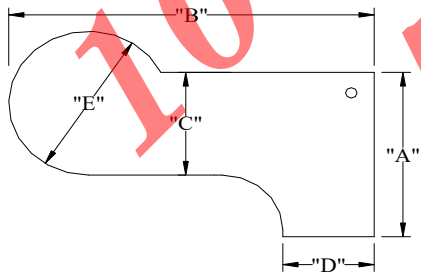

OPTIONS:

Additional Round Grommet 3" add \$ 30 List.
To up-grade to a 6" base add \$80 List.

NOTES:

Please specify left or right extension: add "L" or "R" after "377" in model number.
Please specify edge detail at the end of the model number.
Edge 1, 2, 3 and 6 are perimeter edges.
Edge 4, 5, and 7 are on front (user) edge only; balance of edges are self edge.
Standard 4" black column base.



phone: (510) 259-6217
email: info@actionlaminates.com

EDGE DETAILS

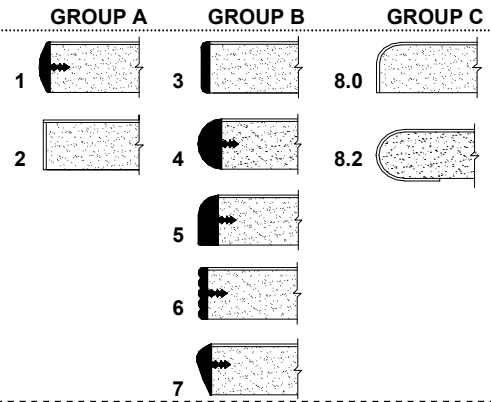

**BASIC ELEMENTS
DESK / CREDENZA SHELLS**

	MODEL NUMBER	SIZE	WT.	GROUP A	GROUP B	GROUP C
<p>Units 48" w</p>	386-2048- □	20 x 48	64	564	587	644
	386-2060- □	20 x 60	71	759	788	863
	386-2072- □	20 x 72	87	799	840	932
	386-2084- □	20 x 84	95	880	937	1052
	386-2096- □	20 x 96	102	880	937	1052
	386-20120- □	20 x 120	126	1121	1179	1323
	386-20144- □	20 x 144	141	1202	1282	1455
	<p>Units 60" to 96"</p>	386-2448- □	24 x 48	77	592	621
386-2460- □		24 x 60	86	782	817	886
386-2472- □		24 x 72	105	828	863	955
386-2484- □		24 x 84	114	909	960	1075
386-2496- □		24 x 96	123	909	960	1075
386-24120- □		24 x 120	151	1144	1208	1351
386-24144- □		24 x 144	169	1231	1305	1484
<p>Units 120" to 144"</p>		386-3048- □	30 x 48	96	707	730
	386-3060- □	30 x 60	107	914	955	1047
	386-3072- □	30 x 72	131	966	1018	1121
	386-3084- □	30 x 84	142	1070	1139	1282
	386-3096- □	30 x 96	153	1070	1139	1282
	386-30120- □	30 x 120	188	1328	1409	1593
	386-30144- □	30 x 144	211	1432	1541	1748

OPTIONS:

Round Grommet 3" add \$ 30 List.

NOTES:

Unit to be used with bridge or return, not independently.
Please specify edge detail at the end of the model number.
Edge 1, 2, 3 and 6 are perimeter edges.
Edge 4, 5, 7 and post formed edges are on front (user) edge only; balance of edges are self edge.
Units 60" to 96" wide include one mid support panel as shown.
Units 120" to 144" wide include two mid support panels as shown.



phone: (510) 259-6217
email: info@actionlaminates.com

EDGE DETAILS

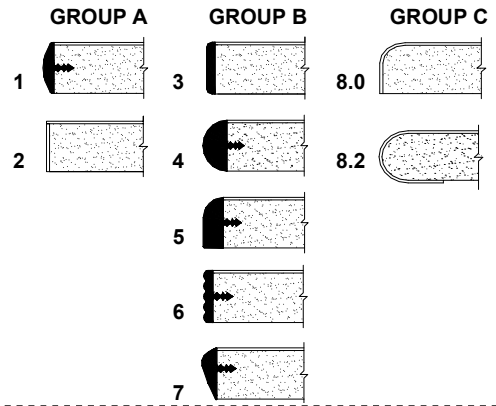

**BASIC ELEMENTS
DESK / CREDENZA W/ PEDESTAL**

	MODEL NUMBER	SIZE	WT.	GROUP A	GROUP B	GROUP C
	387-□-2048-□	20 x 48	137	1259	1288	1340
	387-□-2060-□	20 x 60	144	1300	1328	1403
	387-□-2072-□	20 x 72	160	1495	1524	1616
	387-□-2084-□	20 x 84	168	1570	1622	1742
	387-□-2096-□	20 x 96	175	1570	1622	1742
	387-□-20120-□	20 x 120	199	1656	1725	1863
	387-□-20144-□	20 x 144	214	1886	1967	2145
Units up to 60"w						
	387-□-2448-□	24 x 48	152	1288	1311	1374
	387-□-2460-□	24 x 60	161	1323	1351	1426
	387-□-2472-□	24 x 72	180	1518	1558	1645
	387-□-2484-□	24 x 84	189	1604	1650	1765
	387-□-2496-□	24 x 96	198	1604	1650	1765
	387-□-24120-□	24 x 120	227	1679	1748	1898
	387-□-24144-□	24 x 144	245	1921	1995	2174
Units 72" to 96"						
	387-□-3048-□	30 x 48	176	1426	1461	1530
	387-□-3060-□	30 x 60	188	1484	1518	1610
	387-□-3072-□	30 x 72	211	1691	1737	1846
	387-□-3084-□	30 x 84	223	1794	1857	2001
	387-□-3096-□	30 x 96	234	1794	1857	2001
	387-□-30120-□	30 x 120	269	1898	1972	2162
	387-□-30144-□	30 x 144	292	2168	2260	2478

OPTIONS:

Round Grommet 3" add \$ 30 List.
Substitute laminate F/F pedestal in place of B/B/F pedestal: N/C

NOTES:

Please specify pedestal at left or right:
add "L" or "R" after "387" in model number.
Please specify edge detail at the end of the model number.
Edge 1, 2, 3 and 6 are perimeter edges.
Edge 4, 5, 7 and post formed edges are on front (user) edge only; balance of edges are self edge.
Standard laminate pedestal, includes lock.
Standard pedestal configuration as shown.
Units 72" to 120" wide include one mid support panel as shown.
Units 144" wide include two mid support panels as shown.



phone: (510) 259-6217
email: info@actionlaminates.com

EDGE DETAILS

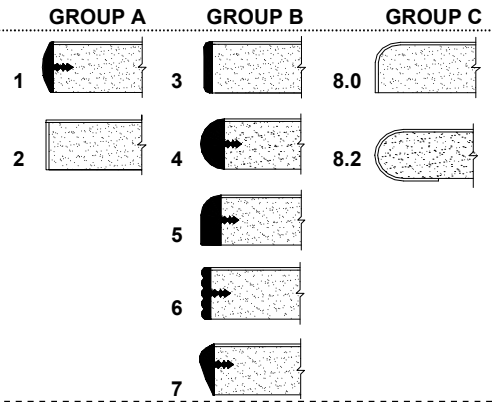

**BASIC ELEMENTS
DESK / CREENZA
W/ DOUBLE PEDESTALS**

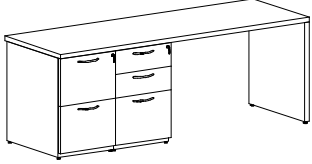
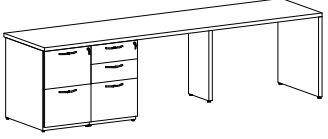
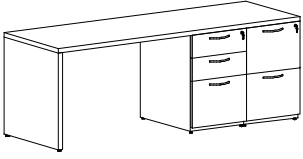
	MODEL NUMBER	SIZE	WT.	GROUP A	GROUP B	GROUP C
LEFT PEDESTAL						
	388-□-2060-□	20 x 60	234	2191	2220	2294
	388-□-2072-□	20 x 72	242	2231	2271	2358
	388-□-2084-□	20 x 84	258	2467	2519	2634
	388-□-2096-□	20 x 96	265	2467	2519	2634
	388-□-20120-□	20 x 120	280	2547	2616	2754
	388-□-20144-□	20 x 144	295	2634	2708	2887
Units up to 72"w						
	388-□-2460-□	24 x 60	255	2231	2266	2340
	388-□-2472-□	24 x 72	264	2271	2306	2398
	388-□-2484-□	24 x 84	283	2501	2559	2674
	388-□-2496-□	24 x 96	292	2501	2559	2674
	388-□-24120-□	24 x 120	310	2588	2651	2800
	388-□-24144-□	24 x 144	328	2674	2749	2921
Units 84" to 144"						
RIGHT PEDESTAL						
	388-□-3060-□	30 x 60	282	2455	2490	2582
	388-□-3072-□	30 x 72	293	2501	2559	2657
	388-□-3084-□	30 x 84	317	2760	2829	2979
	388-□-3096-□	30 x 96	328	2760	2829	2979
	388-□-30120-□	30 x 120	350	2875	2956	3140
	388-□-30144-□	30 x 144	373	2979	3071	3289
Units 84" to 144"						

OPTIONS:

Round Grommet 3" add \$ 30 List.

NOTES:

Please specify pedestal at left or right:
add "L" or "R" after "388" in model number.
Please specify edge detail at the end of the model number.
Edge 1, 2, 3 and 6 are perimeter edges.
Edge 4, 5, 7 and post formed edges are on front (user) edge only; balance of edges are self edge.
Standard laminate pedestal, includes lock.
Standard pedestal configuration as shown.
Units 84" to 144" wide include one mid support panel as shown.



phone: (510) 259-6217
email: info@actionlaminates.com

EDGE DETAILS

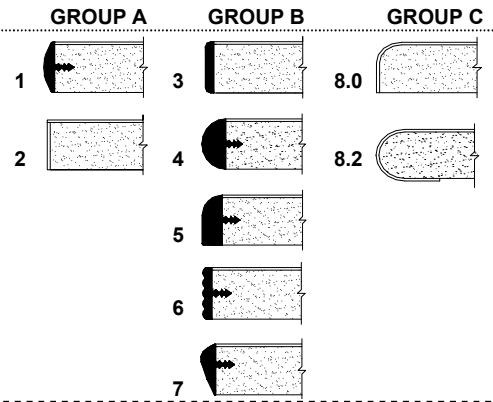

**BASIC ELEMENTS
DESK / CREDENZA
W/ LATERAL FILE**

	MODEL NUMBER	SIZE	WT.	GROUP A	GROUP B	GROUP C
LEFT PEDESTAL						
	389-□-2060-□	20 x 60	189	1829	1857	1932
	389-□-2072-□	20 x 72	197	1869	1909	1995
	389-□-2084-□	20 x 84	213	2099	2156	2271
	389-□-2096-□	20 x 96	220	2099	2156	2271
	389-□-20120-□	20 x 120	235	2185	2254	2392
	389-□-20144-□	20 x 144	250	2271	2352	2524
Units up to 72"w						
	389-□-2460-□	24 x 60	200	1840	1869	1944
	389-□-2472-□	24 x 72	209	1880	1921	2007
	389-□-2484-□	24 x 84	228	2122	2168	2283
	389-□-2496-□	24 x 96	237	2122	2168	2283
	389-□-24120-□	24 x 120	255	2197	2266	2404
	389-□-24144-□	24 x 144	273	2283	2363	2536
Units 84" to 144"						
RIGHT PEDESTAL						
	389-□-3060-□	30 x 60	217	1926	1961	2059
	389-□-3072-□	30 x 72	228	1984	2030	2139
	389-□-3084-□	30 x 84	252	2237	2294	2450
	389-□-3096-□	30 x 96	263	2237	2294	2450
	389-□-30120-□	30 x 120	285	2346	2421	2605
	389-□-30144-□	30 x 144	308	2450	2536	2754
Units 84" to 144"						

OPTIONS:

Round Grommet 3" add \$ 30 List.

NOTES:

Please specify pedestal at left or right:
add "L" or "R" after "389" in model number.
Please specify edge detail at the end of the model number.
Edge 1, 2, 3 and 6 are perimeter edges.
Edge 4, 5, 7 and post formed edges are on front (user) edge only; balance of edges are self edge.
Standard pedestal configuration as shown.
Units 84" to 144" wide include one mid support panel as shown.
Standard laminate lateral file is 18"D x 30" wide, includes lock.



phone: (510) 259-6217
email: info@actionlaminates.com

EDGE DETAILS

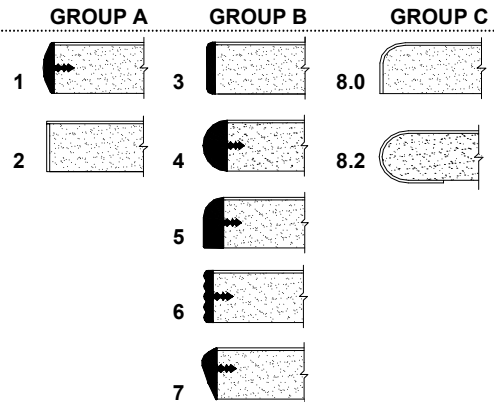

**BASIC ELEMENTS
DESK / CREDENZA
W/ LATERAL FILE AND PEDESTAL**

	MODEL NUMBER	SIZE	WT.	GROUP A	GROUP B	GROUP C
LEFT PEDESTAL						
	378-□-2072-□	20 x 72	287	2754	2800	2887
	378-□-2084-□	20 x 84	294	2841	2898	3013
	378-□-2096-□	20 x 96	310	2996	3048	3163
	378-□-20120-□	20 x 120	325	3076	3145	3283
	378-□-20144-□	20 x 144	340	3163	3237	3410
Units up to 84"w						
	378-□-2472-□	24 x 72	305	2789	2823	2915
	378-□-2484-□	24 x 84	314	2869	2921	3042
	378-□-2496-□	24 x 96	333	3019	3071	3186
	378-□-24120-□	24 x 120	351	3105	3168	3312
	378-□-24144-□	24 x 144	369	3186	3260	3439
RIGHT PEDESTAL						
	378-□-3072-□	30 x 72	334	2956	3002	3111
	378-□-3084-□	30 x 84	345	3059	3117	3266
	378-□-3096-□	30 x 96	369	3220	3278	3421
	378-□-30120-□	30 x 120	391	3324	3398	3582
	378-□-30144-□	30 x 144	414	3427	3513	3732
Units up to 84"w						
	378-□-3072-□	30 x 72	334	2956	3002	3111
	378-□-3084-□	30 x 84	345	3059	3117	3266
	378-□-3096-□	30 x 96	369	3220	3278	3421
	378-□-30120-□	30 x 120	391	3324	3398	3582
	378-□-30144-□	30 x 144	414	3427	3513	3732
Units 96" to 144"						

OPTIONS:
Round Grommet 3" add \$ 30 List.

NOTES:
Please specify pedestal at left or right:
add "L" or "R" after "378" in model number.
Please specify edge detail at the end of the model number.
Edge 1, 2, 3 and 6 are perimeter edges.
Edge 4, 5, 7 and post formed edges are on front (user)
edge only; balance of edges are self edge.
Standard pedestal configuration as shown.
Units 96" to 144" wide include one mid support panel
as shown.
Standard laminate lateral file is 18"D x 30" wide,
includes lock.



phone: (510) 259-6217
email: info@actionlaminates.com

EDGE DETAILS

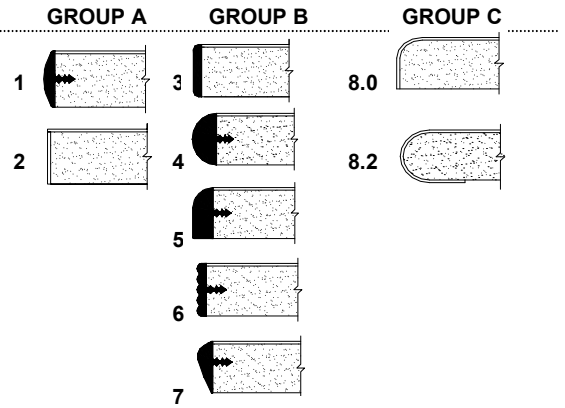

BASIC ELEMENTS CREDENZAS 29" H

MODEL NUMBER	SIZE D x W X H	WT.	# of doors	# of		
				GROUP A	GROUP B	GROUP C

HINGED DOOR CREDENZA

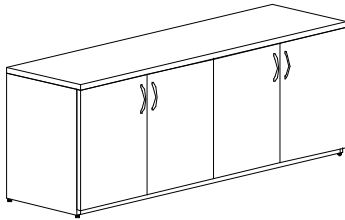

347-2048-□	20 x 48 x 29	145	4	1340	1374	1426
347-2060-□	20 x 60 x 29	188	4	1737	1771	1840
347-2072-□	20 x 72 x 29	218	4	2013	2053	2139
347-2096-□	20 x 96 x 29	290	6	2685	2737	2846
347-2448-□	24 x 48 x 29	162	4	1501	1530	1587
347-2460-□	24 x 60 x 29	210	4	1944	1984	2047
347-2472-□	24 x 72 x 29	243	4	2248	2289	2375
347-2496-□	24 x 96 x 29	324	6	2996	3053	3163

BUFFET CREDENZA

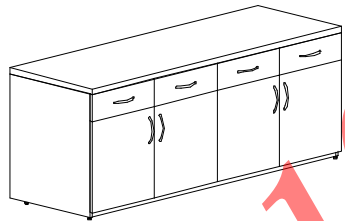

MODEL NUMBER	SIZE D x W X H	WT.	# of Doors & Drawers			
			GROUP A	GROUP B	GROUP C	
348-2048-□	20 x 48 x 29	193	4	1771	1806	1857
348-2060-□	20 x 60 x 29	250	4	2599	2634	2703
348-2072-□	20 x 72 x 29	290	4	2875	2915	3002
348-2096-□	20 x 96 x 29	387	6	3973	4031	4140
348-2448-□	24 x 48 x 29	216	4	1932	1961	2018
348-2460-□	24 x 60 x 29	280	4	2806	2841	2910
348-2472-□	24 x 72 x 29	324	4	3105	3151	3237
348-2496-□	24 x 96 x 29	432	6	4290	4341	4456

OPTIONS:

Round Grommet 3" add \$ 30 List.
Arc pulls available in polished chrome or satin chrome, no upcharge.
Lock for pair of doors, add \$70 list.

NOTES:

Please specify edge detail at the end of the model number.
Standard with black arc pulls.
Standard with one adjustable shelf per opening.



phone: (510) 259-6217
email: info@actionlaminates.com

EDGE DETAILS

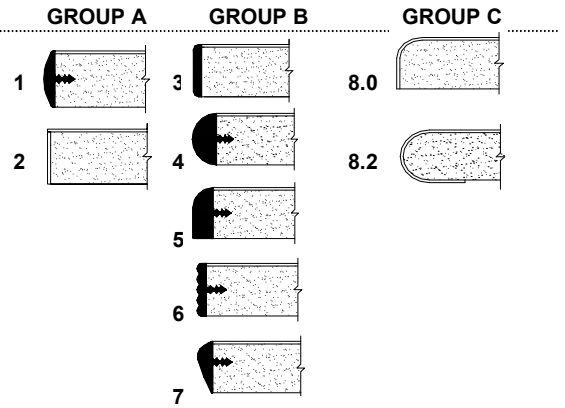

BASIC ELEMENTS CRENZAS 36" H

MODEL NUMBER	SIZE D x W X H	WT.	# of doors	# of		
				GROUP A	GROUP B	GROUP C

HINGED DOOR CRENZENZA

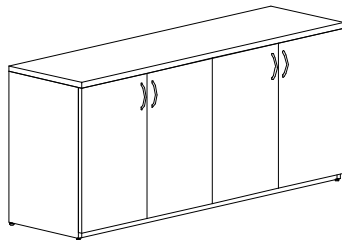

349-2048-□	20 x 48 x 36	162	4	1501	1530	1587
349-2060-□	20 x 60 x 36	210	4	1944	1984	2047
349-2072-□	20 x 72 x 36	243	4	2248	2289	2375
349-2096-□	20 x 96 x 36	324	6	2996	3053	3163
349-2448-□	24 x 48 x 36	180	2	1668	1696	1754
349-2460-□	24 x 60 x 36	234	4	2168	2202	2271
349-2472-□	24 x 72 x 36	270	4	2496	2542	2628
349-2496-□	24 x 96 x 36	360	6	3329	3387	3496

BUFFET CRENZENZA

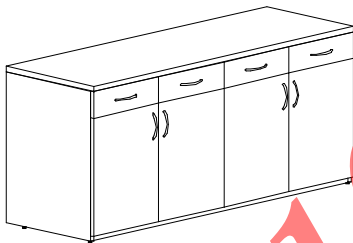

MODEL NUMBER	SIZE D x W X H	WT.	# of Doors & Drawers	# of		
				GROUP A	GROUP B	GROUP C
350-2048-□	20 x 48 x 36	190	4	1932	1961	2018
350-2060-□	20 x 60 x 36	245	4	2806	2841	2910
350-2072-□	20 x 72 x 36	284	4	3105	3151	3237
350-2096-□	20 x 96 x 36	379	6	4290	4341	4456
350-2448-□	24 x 48 x 36	212	4	2099	2128	2185
350-2460-□	24 x 60 x 36	275	4	3025	3065	3134
350-2472-□	24 x 72 x 36	318	4	3358	3404	3490
350-2496-□	24 x 96 x 36	424	6	4623	4675	4784

OPTIONS:

Round Grommet 3" add \$ 30 List.
Arc pulls available in polished chrome or satin chrome, no upcharge.
Lock for pair of doors, add \$70 list.

NOTES:

Please specify edge detail at the end of the model number.
Standard with black arc pulls.
Standard with one adjustable shelf per opening.



phone: (510) 259-6217
email: info@actionlaminates.com

EDGE DETAILS

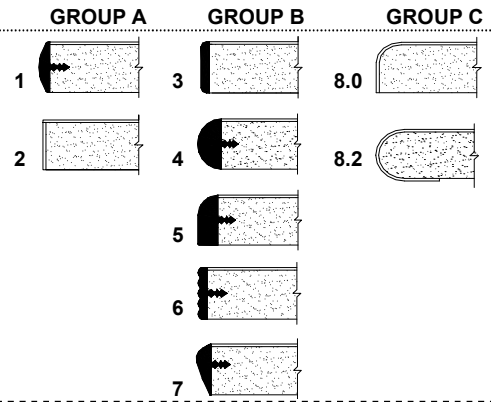

**BASIC ELEMENTS
BRIDGE UNITS**

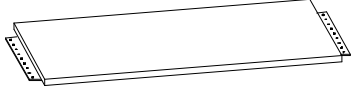
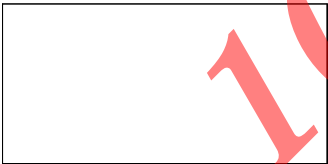
	MODEL NUMBER	SIZE	WT.	GROUP A	GROUP B	GROUP C
 Units up to 48"w	380-2024-□	20 x 24	18	201	224	270
	380-2030-□	20 x 30	22	207	230	282
	380-2036-□	20 x 36	26	213	236	288
	380-2042-□	20 x 42	30	236	259	316
	380-2048-□	20 x 48	33	236	259	316
	380-2060-□	20 x 60	52	426	454	529
	380-2072-□	20 x 72	60	466	506	592
	380-2084-□	20 x 84	68	546	598	719
	380-2096-□	20 x 96	76	546	598	719
 Units 60" to 96"w	380-2424-□	24 x 24	21	201	224	270
	380-2430-□	24 x 30	23	207	230	282
	380-2436-□	24 x 36	30	213	236	288
	380-2442-□	24 x 42	35	236	259	316
	380-2448-□	24 x 48	39	236	259	316
	380-2460-□	24 x 60	59	426	454	529
	380-2472-□	24 x 72	68	466	506	592
	380-2484-□	24 x 84	77	546	604	713
	380-2496-□	24 x 96	86	546	604	713
	380-3030-□	30 x 30	32	242	265	328
	380-3036-□	30 x 36	38	253	282	345
	380-3042-□	30 x 42	43	276	311	374
	380-3048-□	30 x 48	49	276	311	374
	380-3060-□	30 x 60	61	472	518	610
	380-3072-□	30 x 72	82	529	575	684
	380-3084-□	30 x 84	93	633	696	845
	380-3096-□	30 x 96	105	633	696	845

OPTIONS:

Round Grommet 3" add \$ 30 List.

NOTES:

Please specify edge detail at the end of the model number.
 Edge 1, 2, 3 and 6 are perimeter edges.
 Edge 4, 5, 7, 8.0 and 8.2 are on front (user) edge only;
 balance of edges are self edge.
 Standard with flat brackets for mounting.
 Units over 48"wide include a mid support panel as shown.



phone: (510) 259-6217
email: info@actionlaminates.com

EDGE DETAILS

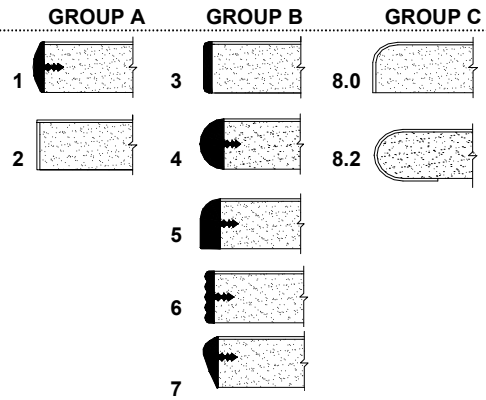

**BASIC ELEMENTS
RETURN UNITS**

	MODEL NUMBER	SIZE	WT.	GROUP A	GROUP B	GROUP C
LEFT RETURN						
 Units up to 48"w	381- □2024- □	20 x 24	36	368	391	437
	381- □2030- □	20 x 30	40	374	403	449
	381- □2036- □	20 x 36	44	380	408	454
	381- □2042- □	20 x 42	48	403	426	477
	381- □2048- □	20 x 48	51	403	426	477
	381- □2060- □	20 x 60	70	592	621	696
	381- □2072- □	20 x 72	77	633	673	759
	381- □2084- □	20 x 84	84	719	771	886
	381- □2096- □	20 x 96	92	719	771	886
	 Units 60" to 96"w	381- □2424- □	24 x 24	43	380	408
381- □2430- □		24 x 30	48	385	414	460
381- □2436- □		24 x 36	52	391	420	466
381- □2442- □		24 x 42	57	414	437	500
381- □2448- □		24 x 48	61	414	437	500
381- □2460- □		24 x 60	81	610	633	713
381- □2472- □		24 x 72	90	644	690	771
381- □2484- □		24 x 84	99	730	782	897
381- □2496- □		24 x 96	108	730	782	897
RIGHT RETURN						
 Units up to 48"w	381- □3030- □	30 x 30	58	420	449	512
	381- □3036- □	30 x 36	64	431	460	529
	381- □3042- □	30 x 42	69	454	489	558
	381- □3048- □	30 x 48	75	454	489	558
	381- □3060- □	30 x 60	97	656	696	788
	381- □3072- □	30 x 72	109	713	759	868
	381- □3084- □	30 x 84	120	817	874	1024
	381- □3096- □	30 x 96	131	817	874	1024

OPTIONS:
Round Grommet 3" add \$ 30 List.

NOTES:
Please specify left or right return: add "L" or "R" after "381" in model number.
Please specify edge detail at the end of the model number.
Edge 1, 2, 3 and 6 are perimeter edges.
Edge 4, 5, 7 and post formed edges are on front (user) edge only; balance of edges are self edge.
Standard with flat bracket for mounting.
Units over 48" wide include a mid support panel as shown.



phone: (510) 259-6217
email: info@actionlaminates.com

EDGE DETAILS

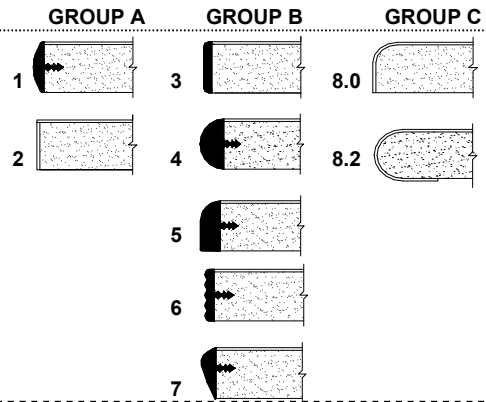

BASIC ELEMENTS
RETURN UNITS W/ PEDESTAL

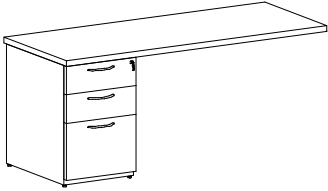
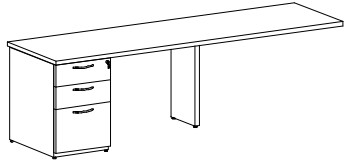
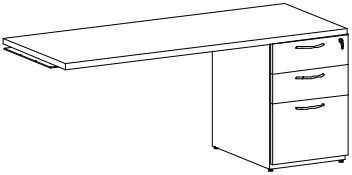
	MODEL NUMBER	SIZE	WT.	GROUP A	GROUP B	GROUP C
LEFT RETURN						
	382- □2024- □	20 x 24	110	1064	1081	1127
	382- □2030- □	20 x 30	114	1070	1087	1144
	382- □2036- □	20 x 36	118	1075	1093	1150
	382- □2042- □	20 x 42	124	1087	1116	1173
	382- □2048- □	20 x 48	127	1087	1116	1173
	382- □2060- □	20 x 60	135	1133	1162	1236
	382- □2072- □	20 x 72	153	1323	1369	1443
	382- □2084- □	20 x 84	160	1409	1461	1570
	382- □2096- □	20 x 96	175	1409	1461	1570
Units up to 60"w						
	382- □2424- □	24 x 24	115	1075	1093	1144
	382- □2430- □	24 x 30	120	1081	1104	1156
	382- □2436- □	24 x 36	124	1087	1110	1162
	382- □2442- □	24 x 42	129	1104	1127	1190
	382- □2448- □	24 x 48	133	1104	1127	1190
	382- □2460- □	24 x 60	153	1150	1173	1254
	382- □2472- □	24 x 72	162	1334	1380	1461
	382- □2484- □	24 x 84	171	1420	1478	1593
	382- □2496- □	24 x 96	190	1420	1478	1593
Units 72" to 96"w						
RIGHT RETURN						
	382- □3030- □	30 x 30	135	1190	1213	1271
	382- □3036- □	30 x 36	141	1196	1219	1294
	382- □3042- □	30 x 42	146	1219	1242	1323
	382- □3048- □	30 x 48	152	1219	1242	1323
	382- □3060- □	30 x 60	174	1271	1311	1403
	382- □3072- □	30 x 72	186	1478	1518	1633
	382- □3084- □	30 x 84	197	1581	1639	1783
	382- □3096- □	30 x 96	208	1581	1639	1783
	Units 72" to 96"w					

OPTIONS:

Round Grommet 3" add \$ 30 List.
Substitute laminate F/F pedestal in place of B/B/F pedestal: N/C

NOTES:

Please specify left or right return: add "L" or "R" after "382" in model number.
Please specify edge detail at the end of the model number.
Edge 1, 2, 3 and 6 are perimeter edges.
Edge 4, 5, 7 and post formed edges are on front (user) edge only; balance of edges are self edge.
Standard with flat bracket for mounting.
Units over 60" wide include a mid support panel as shown.
Standard laminate BBF pedestal, includes lock.



phone: (510) 259-6217
email: info@actionlaminates.com

EDGE DETAILS

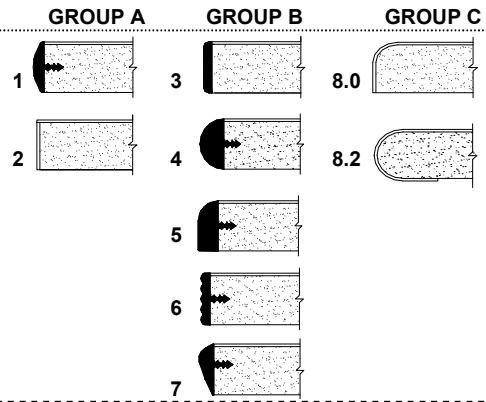

**BASIC ELEMENTS
RETURN UNITS W/ DOUBLE PEDESTALS**

	MODEL NUMBER	SIZE	WT.	GROUP A	GROUP B	GROUP C
LEFT RETURN						
	383- 2036-	20 x 36	215	1961	1990	2041
	383- 2042-	20 x 42	219	1984	2007	2059
	383- 2048-	20 x 48	222	1984	2007	2059
	383- 2060-	20 x 60	229	2024	2053	2128
	383- 2072-	20 x 72	236	2070	2099	2191
	383- 2084-	20 x 84	243	2145	2197	2312
	383- 2096-	20 x 96	262	2294	2352	2467
Units up to 84"w						
	383- 2436-	24 x 36	219	1990	2018	2070
	383- 2442-	24 x 42	224	2007	2036	2093
	383- 2448-	24 x 48	228	2007	2036	2093
	383- 2460-	24 x 60	237	2047	2082	2156
	383- 2472-	24 x 72	246	2093	2128	2214
	383- 2484-	24 x 84	252	2179	2220	2346
	383- 2496-	24 x 96	272	2323	2375	2490
Units 96"w						
RIGHT RETURN						
	383- 3036-	30 x 36	227	2168	2197	2266
	383- 3042-	30 x 42	233	2191	2220	2294
	383- 3048-	30 x 48	238	2191	2220	2294
	383- 3060-	30 x 60	249	2248	2283	2375
	383- 3072-	30 x 72	270	2294	2346	2455
	383- 3084-	30 x 84	281	2398	2461	2611
	383- 3096-	30 x 96	303	2547	2616	2754
Units 96"w						

OPTIONS:
Round Grommet 3" add \$ 30 List.

NOTES:
Please specify left or right return: add "L" or "R" after "383" in model number.
Please specify edge detail at the end of the model number.
Edge 1, 2, 3 and 6 are perimeter edges.
Edge 4, 5, 7 and post formed edges are on front (user) edge only; balance of edges are self edge.
Standard with flat bracket for mounting.
Units over 84" wide include a mid support panel as shown.
Standard laminate pedestal includes lock.
Standard pedestal configuration is as shown.



phone: (510) 259-6217
email: info@actionlaminates.com

EDGE DETAILS

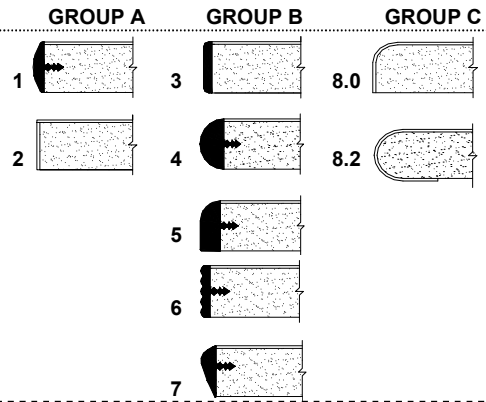

**BASIC ELEMENTS
RETURN UNITS W/ LATERAL FILE**

	MODEL NUMBER	SIZE	WT.	GROUP A	GROUP B	GROUP C
LEFT RETURN						
	384- □2036- □	20 x 36	160	1604	1622	1673
	384- □2042- □	20 x 42	164	1616	1645	1702
	384- □2048- □	20 x 48	168	1616	1645	1702
	384- □2060- □	20 x 60	175	1656	1691	1765
	384- □2072- □	20 x 72	182	1702	1742	1829
	384- □2084- □	20 x 84	189	1783	1834	1949
	384- □2096- □	20 x 96	209	1938	1990	2099
	Units up to 84"w					
	384- □2436- □	24 x 36	164	1604	1622	1673
	384- □2442- □	24 x 42	169	1616	1645	1702
	384- □2448- □	24 x 48	173	1616	1645	1702
	384- □2460- □	24 x 60	182	1656	1691	1765
	384- □2472- □	24 x 72	191	1702	1742	1829
	384- □2484- □	24 x 84	200	1783	1834	1949
	384- □2496- □	24 x 96	220	1938	1990	2099
	Units 96"w					
RIGHT RETURN						
	384- □3036- □	30 x 36	171	1639	1668	1737
	384- □3042- □	30 x 42	176	1662	1691	1765
	384- □3048- □	30 x 48	182	1662	1691	1765
	384- □3060- □	30 x 60	193	1719	1754	1846
	384- □3072- □	30 x 72	205	1765	1817	1926
	384- □3084- □	30 x 84	216	1863	1932	2082
	384- □3096- □	30 x 96	238	2024	2082	2231
	Units 96"w					

OPTIONS:
Round Grommet 3" add \$ 30 List.

NOTES:
Please specify left or right return: add "L" or "R" after "384" in model number.
Please specify edge detail at the end of the model number.
Edge 1, 2, 3 and 6 are perimeter edges.
Edge 4, 5, 7 and post formed edges are on front (user) edge only; balance of edges are self edge.
Standard with flat bracket for mounting.
Units over 84" wide include a mid support panel as shown.
Standard laminate lateral file is 18"D x 30" wide, includes lock.



phone: (510) 259-6217
email: info@actionlaminates.com

EDGE DETAILS

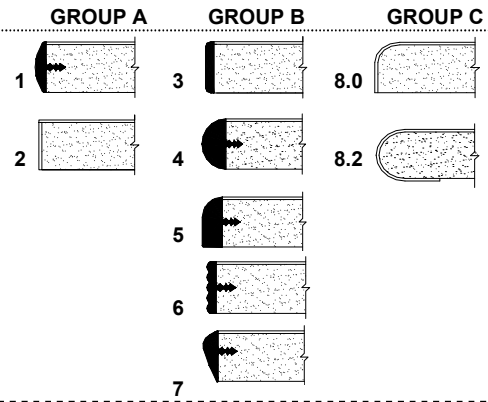

**BASIC ELEMENTS
RETURN UNITS W/ LATERAL FILE
AND PEDESTAL**

	MODEL NUMBER	SIZE	WT.	GROUP A	GROUP B	GROUP C
	385- □2048- □	20 x 48	263	2513	2536	2599
	385- □2060- □	20 x 60	270	2547	2582	2651
	385- □2072- □	20 x 72	277	2599	2628	2720
	385- □2084- □	20 x 84	284	2674	2726	2841
	385- □2096- □	20 x 96	293	2674	2726	2841

Units up to 96"w

	385- □2448- □	24 x 48	268	2524	2547	2611
	385- □2460- □	24 x 60	277	2565	2599	2668
	385- □2472- □	24 x 72	286	2611	2639	2731
	385- □2484- □	24 x 84	295	2691	2737	2852
	385- □2496- □	24 x 96	304	2691	2737	2852

RIGHT RETURN

Units up to 96"w

	385- □3048- □	30 x 48	352	2634	2668	2737
	385- □3060- □	30 x 60	371	2691	2726	2818
	385- □3072- □	30 x 72	390	2737	2789	2898
	385- □3084- □	30 x 84	398	2841	2904	3053
	385- □3096- □	30 x 96	396	2841	2904	3053

OPTIONS:

Round Grommet 3" add \$ 30 List.

NOTES:

Please specify left or right return: add "L" or "R" after "385" in model number.

Please specify edge detail at the end of the model number.

Edge 1, 2, 3 and 6 are perimeter edges.

Edge 4, 5, 7 and post formed edges are on front (user) edge only; balance of edges are self edge.

Standard with flat bracket for mounting.

Standard laminate pedestal includes lock.

Standard laminate lateral file is 18"D x 30" wide, includes lock.

Standard pedestal configuration as shown.



phone: (510) 259-6217
email: info@actionlaminates.com

EDGE DETAILS

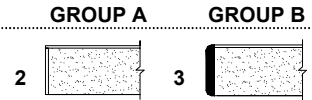

BASIC ELEMENTS
WALL MOUNT OVERHEAD STORAGE MODULES

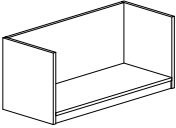
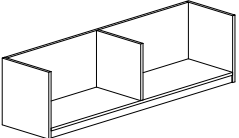
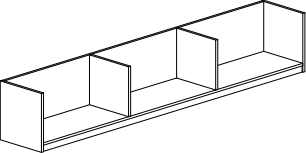
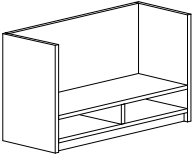
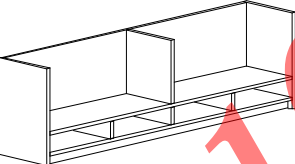
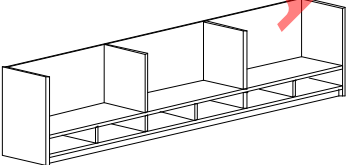
	MODEL NUMBER	SIZE	WT.	OPENINGS	GROUP A	GROUP B
OPEN, NO TOP						
SINGLE		D x W x H				
	393-1430-□	14 x 30 x 18	33	1	523	575
	393-1436-□	14 x 36 x 18	38	1	546	604
	393-1442-□	14 x 42 x 18	42	1	604	656
DOUBLE						
	393-1448-□	14 x 48 x 18	52	2	650	719
	393-1460-□	14 x 60 x 18	61	2	730	799
	393-1472-□	14 x 72 x 18	69	2	811	886
TRIPLE						
	393-1484-□	14 x 84 x 18	84	3	1093	1208
	393-1496-□	14 x 96 x 18	92	3	1093	1208
OPEN, NO TOP, WITH ORGANIZER						
SINGLE						
	394-1430-□	14 x 30 x 23	55	3	707	782
	394-1436-□	14 x 36 x 23	62	3	765	845
	394-1442-□	14 x 42 x 23	69	3	845	932
DOUBLE						
	394-1448-□	14 x 48 x 23	88	6	966	1064
	394-1460-□	14 x 60 x 23	102	6	1093	1208
	394-1472-□	14 x 72 x 23	116	6	1219	1340
TRIPLE						
	394-1484-□	14 x 84 x 23	138	9	1622	1788
	394-1496-□	14 x 96 x 23	152	9	1622	1788

OPTIONS:

Task light not included; see accessories page 119.

NOTES:

Please specify edge detail at the end of the model number.
Standard with recessed back and wall cleat.
Standard with task light fascia.
Unit has 12" depth clearance.
Organizer has 4" height clearance.



phone: (510) 259-6217
email: info@actionlaminates.com

EDGE DETAILS

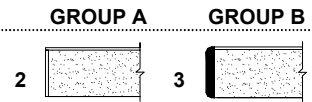

BASIC ELEMENTS
WALL MOUNT OVERHEAD STORAGE MODULES

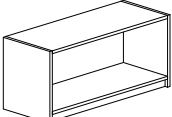
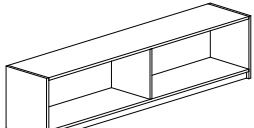
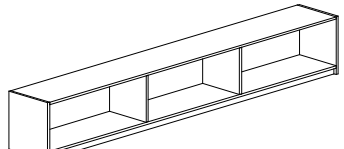
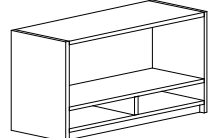
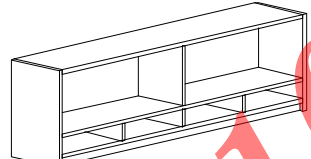
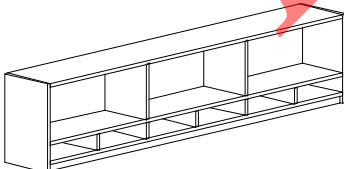
	MODEL NUMBER	SIZE	WT.	OPENINGS	GROUP A	GROUP B
OPEN, WITH TOP						
SINGLE		D x W x H				
	390-1430-□	14 x 30 x 18	43	1	610	667
	390-1436-□	14 x 36 x 18	50	1	650	719
	390-1442-□	14 x 42 x 18	56	1	725	794
DOUBLE						
	390-1448-□	14 x 48 x 18	68	2	794	874
	390-1460-□	14 x 60 x 18	81	2	903	995
	390-1472-□	14 x 72 x 18	93	2	1018	1121
TRIPLE						
	390-1484-□	14 x 84 x 18	112	3	1380	1512
	390-1496-□	14 x 96 x 18	124	3	1380	1512
OPEN, WITH TOP, WITH ORGANIZER						
SINGLE						
	395-1430-□	14 x 30 x 24	65	3	794	874
	395-1436-□	14 x 36 x 24	74	3	868	955
	395-1442-□	14 x 42 x 24	83	3	966	1064
DOUBLE						
	395-1448-□	14 x 48 x 24	104	6	1110	1219
	395-1460-□	14 x 60 x 24	122	6	1271	1403
	395-1472-□	14 x 72 x 24	140	6	1426	1570
TRIPLE						
	395-1484-□	14 x 84 x 24	166	9	1909	2093
	395-1496-□	14 x 96 x 24	184	9	1909	2093

OPTIONS:

Task light not included; see accessories page 119.

NOTES:

- Please specify edge detail at the end of the model number.
- Standard with recessed back and wall cleat.
- Standard with task light fascia.
- Unit has 12" depth clearance.
- Organizer has 4" height clearance.



phone: (510) 259-6217
email: info@actionlaminates.com

EDGE DETAILS

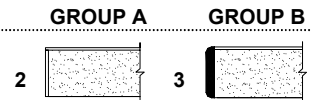

BASIC ELEMENTS WALL MOUNT OVERHEAD STORAGE MODULES

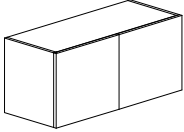
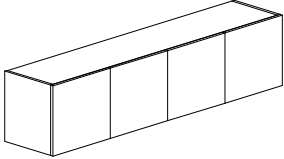
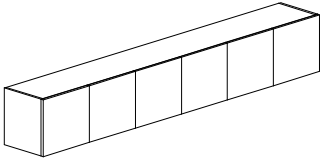
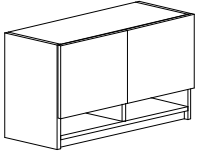
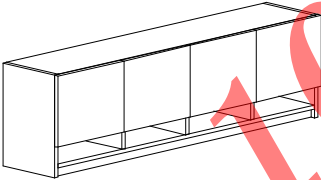
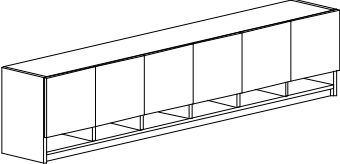
	MODEL NUMBER	SIZE	WT.	OPENINGS	GROUP A	GROUP B
HINGED DOORS						
TWO DOORS		D x W x H				
	391-1530- □	15 x 30 x 18	55	1	713	782
	391-1536- □	15 x 36 x 18	63	1	776	857
	391-1542- □	15 x 42 x 18	72	1	868	955
FOUR DOORS						
	391-1548- □	15 x 48 x 18	86	2	966	1064
	391-1560- □	15 x 60 x 18	103	2	1116	1225
	391-1572- □	15 x 72 x 18	120	2	1265	1392
SIX DOORS						
	391-1584- □	15 x 84 x 18	143	3	1708	1875
	391-1596- □	15 x 96 x 18	160	3	1708	1875
HINGED DOORS, WITH ORGANIZER						
TWO DOORS						
	396-1530- □	15 x 30 x 24	80	3	897	989
	396-1536- □	15 x 36 x 24	92	3	989	1087
	396-1542- □	15 x 42 x 24	104	3	1110	1219
FOUR DOORS						
	396-1548- □	15 x 48 x 24	128	6	1282	1409
	396-1560- □	15 x 60 x 24	152	6	1484	1633
	396-1572- □	15 x 72 x 24	176	6	1679	1846
SIX DOORS						
	396-1584- □	15 x 84 x 24	208	9	2237	2461
	396-1596- □	15 x 96 x 24	232	9	2237	2461

OPTIONS:

Task light not included; see accessories page 119.
Lock for pair of doors, add \$70 list.
Master key, \$30.
Key-change tool, \$30.

NOTES:

Please specify edge detail at the end of the model number.
Standard with recessed back and wall cleat.
Standard with task light fascia.
Unit has 12" depth clearance.
Organizer has 4" height clearance.



phone: (510) 259-6217
email: info@actionlaminates.com

EDGE DETAILS

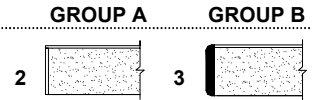

BASIC ELEMENTS
WALL MOUNT OVERHEAD STORAGE MODULES

	MODEL NUMBER	SIZE	WT.	OPENINGS	GROUP A	GROUP B
--	--------------	------	-----	----------	---------	---------

SINGLE

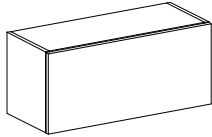

LID DOORS

		D x W x H				
	392-1530-□	15 x 30 x 18	55	1	851	914
	392-1536-□	15 x 36 x 18	63	1	909	989
	392-1542-□	15 x 42 x 18	72	1	1001	1087

DOUBLE

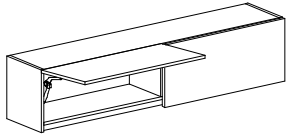

	392-1548-□	15 x 48 x 18	86	2	1236	1334
	392-1560-□	15 x 60 x 18	103	2	1386	1495
	392-1572-□	15 x 72 x 18	120	2	1541	1662

TRIPLE

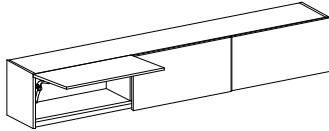

	392-1584-□	15 x 84 x 18	143	3	2116	2283
	392-1596-□	15 x 96 x 18	160	3	2116	2283

LID DOORS, WITH ORGANIZER

SINGLE

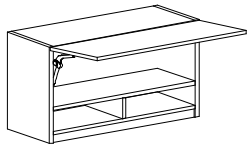

	397-1530-□	15 x 30 x 24	70	3	1035	1127
	397-1536-□	15 x 36 x 24	80	3	1127	1225
	397-1542-□	15 x 42 x 24	90	3	1242	1351

DOUBLE

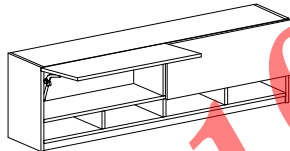

	397-1548-□	15 x 48 x 24	112	6	1553	1679
	397-1560-□	15 x 60 x 24	132	6	1754	1903
	397-1572-□	15 x 72 x 24	152	6	1949	2116

TRIPLE

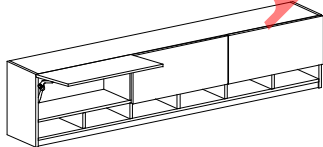

	397-1584-□	15 x 84 x 24	180	9	2645	2869
	397-1596-□	15 x 96 x 24	200	9	2645	2869

OPTIONS:

Task light not included; see accessories page 119.
Single door lock add \$50 list.
Master key, \$30.
Key-change tool, \$30.

NOTES:

Please specify edge detail at the end of the model number.
Standard with recessed back and wall cleat.
Standard with task light fascia.
Unit has 12" depth clearance.
Organizer has 4" height clearance.



phone: (510) 259-6217
email: info@actionlaminates.com

BASIC ELEMENTS HUTCH UNITS

EDGE DETAILS

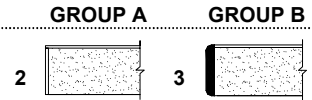

MODEL NUMBER SIZE WT. OPENINGS GROUP A GROUP B

OPEN, NO TOP

SINGLE

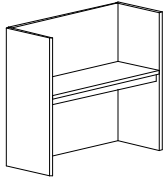

	D x W x H				
322-1430-□	14 x 30 x 36	57	1	782	863
322-1436-□	14 x 36 x 36	63	1	811	886
322-1442-□	14 x 42 x 36	70	1	891	983

DOUBLE

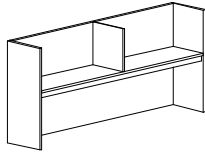

322-1448-□	14 x 48 x 36	88	2	949	1047
322-1460-□	14 x 60 x 36	101	2	1058	1162
322-1472-□	14 x 72 x 36	114	2	1167	1288

TRIPLE

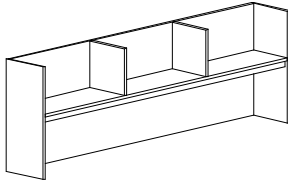

322-1484-□	14 x 84 x 36	139	3	1518	1668
322-1496-□	14 x 96 x 36	152	3	1518	1668

OPEN, NO TOP, WITH ORGANIZER

SINGLE

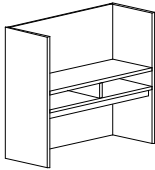

323-1430-□	14 x 30 x 36	73	3	972	1070
323-1436-□	14 x 36 x 36	81	3	1024	1127
323-1442-□	14 x 42 x 36	90	3	1133	1242

DOUBLE

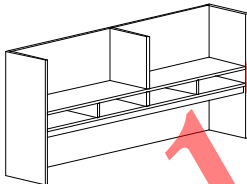

323-1448-□	14 x 48 x 36	116	6	1259	1386
323-1460-□	14 x 60 x 36	133	6	1420	1570
323-1472-□	14 x 72 x 36	150	6	1581	1737

TRIPLE

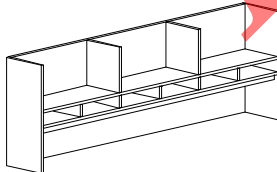

323-1484-□	14 x 84 x 36	179	9	2047	2254
323-1496-□	14 x 96 x 36	196	9	2047	2254

OPTIONS:

Task light not included; see accessories page 119.
Add 10% for unit 37" to 48" high.

NOTES:

Please specify edge detail at the end of the model number.
Standard with fully enclosed, finished back.
Standard with 3" round grommet in back panel.
Standard with task light fascia.
Standard with attachment hardware.
Organizer has 4" height clearance.



phone: (510) 259-6217
email: info@actionlaminates.com

BASIC ELEMENTS HUTCH UNITS

EDGE DETAILS

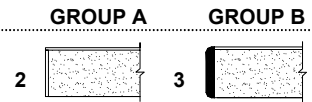

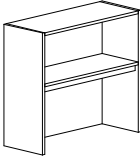
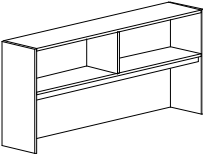
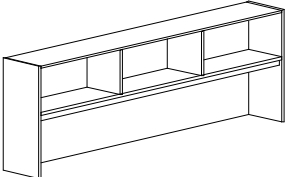
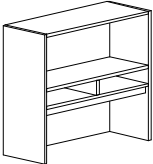
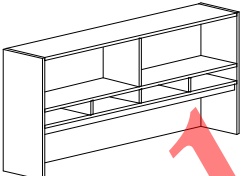
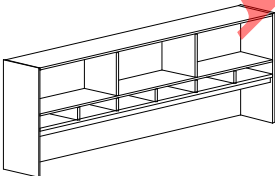
	MODEL NUMBER	SIZE	WT.	OPENINGS	GROUP A	GROUP B
OPEN, WITH TOP						
SINGLE		D x W x H				
	324-1430-□	14 x 30 x 36	67	1	868	955
	324-1436-□	14 x 36 x 36	75	1	909	1001
	324-1442-□	14 x 42 x 36	84	1	1018	1121
DOUBLE						
	324-1448-□	14 x 48 x 36	104	2	1087	1202
	324-1460-□	14 x 60 x 36	121	2	1231	1351
	324-1472-□	14 x 72 x 36	138	2	1380	1512
TRIPLE						
	324-1484-□	14 x 84 x 36	167	3	1806	1984
	324-1496-□	14 x 96 x 36	184	3	1806	1984
OPEN, WITH TOP, WITH ORGANIZER						
SINGLE						
	325-1430-□	14 x 30 x 36	83	3	1058	1162
	325-1436-□	14 x 36 x 36	93	3	1127	1242
	325-1442-□	14 x 42 x 36	104	3	1259	1392
DOUBLE						
	325-1448-□	14 x 48 x 36	132	6	1403	1547
	325-1460-□	14 x 60 x 36	153	6	1599	1760
	325-1472-□	14 x 72 x 36	174	6	1783	1961
TRIPLE						
	325-1484-□	14 x 84 x 36	207	9	2323	2565
	325-1496-□	14 x 96 x 36	228	9	2323	2565

OPTIONS:

Task light not included; see accessories page 119.
Add 10% for unit 37" to 48" high.

NOTES:

Please specify edge detail at the end of the model number.
Standard with fully enclosed, finished back.
Standard with 3" round grommet in back panel.
Standard with task light fascia.
Standard with attachment hardware.
Organizer has 4" height clearance.



phone: (510) 259-6217
email: info@actionlaminates.com

EDGE DETAILS

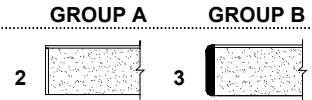

**BASIC ELEMENTS
HUTCH UNITS**

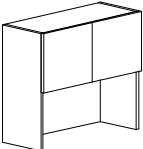
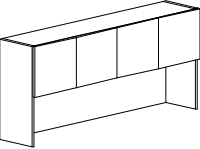
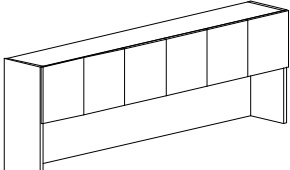
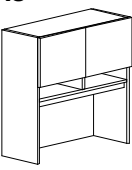
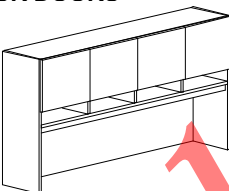
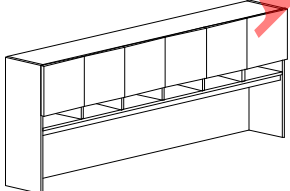
	MODEL NUMBER	SIZE	WT.	OPENINGS	GROUP A	GROUP B
HINGED DOORS						
TWO DOORS		D x W x H				
	326-1530-□	15 x 30 x 36	89	1	972	1070
	326-1536-□	15 x 36 x 36	102	1	1041	1144
	326-1542-□	15 x 42 x 36	115	1	1162	1282
FOUR DOORS						
	326-1548-□	15 x 48 x 36	140	2	1259	1386
	326-1560-□	15 x 60 x 36	166	2	1438	1587
	326-1572-□	15 x 72 x 36	192	2	1622	1783
SIX DOORS						
	326-1584-□	15 x 84 x 36	230	3	2133	2352
	326-1596-□	15 x 96 x 36	256	3	2133	2352
HINGED DOORS, WITH ORGANIZER						
TWO DOORS						
	327-1530-□	15 x 30 x 36	105	3	1162	1282
	327-1536-□	15 x 36 x 36	120	3	1254	1380
	327-1542-□	15 x 42 x 36	135	3	1403	1553
FOUR DOORS						
	327-1548-□	15 x 48 x 36	168	6	1576	1731
	327-1560-□	15 x 60 x 36	198	6	1840	2024
	327-1572-□	15 x 72 x 36	228	6	2007	2202
SIX DOORS						
	327-1584-□	15 x 84 x 36	270	9	2662	2927
	327-1596-□	15 x 96 x 36	300	9	2662	2927

OPTIONS:

- Task light not included; see accessories page 119.
- Add 10% for unit 37" to 48" high.
- Lock for pair of doors, add \$70 list.
- Master key, \$30.
- Key-change tool, \$30.

NOTES:

- Please specify edge detail at the end of the model number.
- Standard with fully enclosed, finished back.
- Standard with 3" round grommet in back panel.
- Standard with task light fascia.
- Standard with attachment hardware.
- Organizer has 4" height clearance.



phone: (510) 259-6217
email: info@actionlaminates.com

BASIC ELEMENTS HUTCH UNITS

EDGE DETAILS

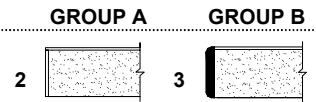

MODEL NUMBER SIZE WT. OPENINGS GROUP A GROUP B

SINGLE

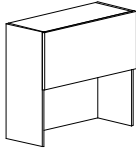

LID DOORS

D x W x H

328-1530-□	15 x 30 x 36	89	1	1173	1277
328-1536-□	15 x 36 x 36	102	1	1236	1346
328-1542-□	15 x 42 x 36	115	1	1357	1484

DOUBLE

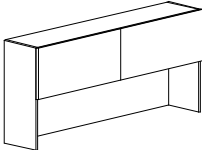

328-1548-□	15 x 48 x 36	140	2	1662	1794
328-1560-□	15 x 60 x 36	166	2	1840	2001
328-1572-□	15 x 72 x 36	192	2	2024	2202

TRIPLE

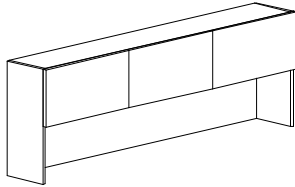

328-1584-□	15 x 84 x 36	230	3	2731	2973
328-1596-□	15 x 96 x 36	256	3	2731	2973

LID DOORS, WITH ORGANIZER

SINGLE

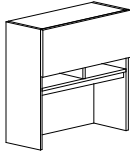

329-1530-□	15 x 30 x 36	105	3	1357	1484
329-1536-□	15 x 36 x 36	120	3	1455	1581
329-1542-□	15 x 42 x 36	135	3	1604	1754

DOUBLE

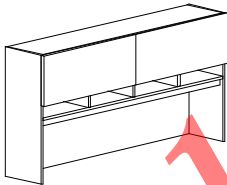

329-1548-□	15 x 48 x 36	168	6	1972	2145
329-1560-□	15 x 60 x 36	198	6	2237	2438
329-1572-□	15 x 72 x 36	228	6	2404	2622

TRIPLE

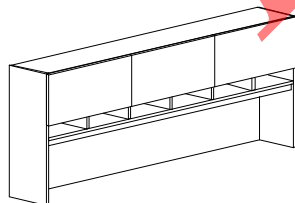

329-1584-□	15 x 84 x 36	270	9	3260	3548
329-1596-□	15 x 96 x 36	300	9	3260	3548

OPTIONS:

- Task light not included; see accessories page 119.
- Add 10% for unit 37" to 48" high.
- Single door lock add \$50 list.
- Master key, \$30.
- Key-change tool, \$30.

NOTES:

- Please specify edge detail at the end of the model number.
- Standard with fully enclosed, finished back.
- Standard with 3" round grommet in back panel.
- Standard with task light fascia.
- Standard with attachment hardware.
- Organizer has 4" height clearance.



phone: (510) 259-6217
email: info@actionlaminates.com

EDGE DETAILS

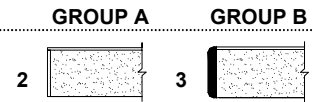

BASIC ELEMENTS
BOOKCASE / HUTCH UNITS

	MODEL NUMBER	SIZE	WT.	ADJ. SHELVES	GROUP A	GROUP B
SINGLE	Single		D x W x H			
	336-3043-□	12 x 30 x 43	71	2	736	811
	336-3643-□	12 x 36 x 43	81	2	845	932
	Double					
	336-4243-□	12 x 42 x 43	101	2	1006	1116
	336-4843-□	12 x 48 x 43	111	2	1058	1162
	336-6043-□	12 x 60 x 43	131	2	1242	1369
	336-7243-□	12 x 72 x 43	151	2	1420	1564
	Single					
	336-3055-□	12 x 30 x 55	92	3	949	1047
336-3655-□	12 x 36 x 55	105	3	1075	1190	
DOUBLE	Double					
	336-4255-□	12 x 42 x 55	131	4	1294	1420
	336-4855-□	12 x 48 x 55	144	4	1340	1484
	336-6055-□	12 x 60 x 55	170	4	1581	1737
	336-7255-□	12 x 72 x 55	196	4	1823	2007
	Single					
	337-3043-□	15 x 30 x 43	89	2	891	983
	337-3643-□	15 x 36 x 43	100	2	1018	1121
	Double					
	337-4243-□	15 x 42 x 43	111	2	1139	1259
337-4843-□	15 x 48 x 43	122	2	1196	1311	
337-6043-□	15 x 60 x 43	144	2	1403	1547	
337-7243-□	15 x 72 x 43	186	2	1829	2007	
Single						
337-3055-□	15 x 30 x 55	131	3	1121	1231	
337-3655-□	15 x 36 x 55	131	3	1271	1403	
Double						
337-4255-□	15 x 42 x 55	156	4	1599	1760	
337-4855-□	15 x 48 x 55	169	4	1650	1817	
337-6055-□	15 x 60 x 55	211	4	2059	2271	
337-7255-□	15 x 72 x 55	236	4	2300	2530	

OPTIONS:

NOTES:

Please specify edge detail at the end of the model number.

Standard with fully enclosed, finished back.

Standard with attachment hardware.

42" w - 72" w include fixed height shelf at bottom with 18" height clearance below shelf.



phone: (510) 259-6217
email: info@actionlaminates.com

EDGE DETAILS

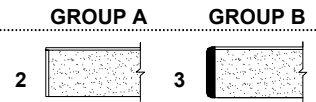

**BASIC ELEMENTS
LATERAL FILES**

	MODEL NUMBER	SIZE	WT.	DRAWERS	GROUP A	GROUP B
		D x W x H				
	338-2030-□	20 x 30 x 29	155	2	1507	1524
	338-2036-□	20 x 36 x 29	180	2	1610	1633
	338-2042-□	20 x 42 x 29	200	2	1794	1823
	338-2430-□	24 x 30 x 29	171	2	1587	1604
	338-2436-□	24 x 36 x 29	198	2	1691	1719
	338-2442-□	24 x 42 x 29	220	2	1880	1915
	338-2030-42-□	20 x 30 x 42	220	3	2174	2231
	338-2036-42-□	20 x 36 x 42	255	3	2312	2369
	338-2042-42-□	20 x 42 x 42	283	3	2559	2622
	338-2430-42-□	24 x 30 x 42	243	3	2289	2346
	338-2436-42-□	24 x 36 x 42	282	3	2438	2484
	338-2442-42-□	24 x 42 x 42	312	3	2691	2749
	338-2030-54-□	20 x 30 x 54	285	4	2800	2869
	338-2036-54-□	20 x 36 x 54	330	4	2984	3048
	338-2042-54-□	20 x 42 x 54	266	4	3490	3370
	338-2430-54-□	24 x 30 x 54	315	4	2938	3007
	338-2436-54-□	24 x 36 x 54	364	4	3128	3197
	338-2442-54-□	24 x 42 x 54	404	4	3669	3536
	338-2060-□	20 x 60 x 29	308	4	2737	2777
	338-2072-□	20 x 72 x 29	360	4	2933	2979
	338-2084-□	20 x 84 x 29	400	4	3260	3312
	338-2460-□	24 x 60 x 29	339	4	2881	2910
	338-2472-□	24 x 72 x 29	396	4	3082	3128
	338-2484-□	24 x 84 x 29	440	4	3427	3467

Options

Arc pulls in polished chrome or satin chrome, no upcharge.
Master key, \$30.
Key-change tool, \$30.

NOTES:

Please specify edge detail at the end of the model number.
Standard with Arc Pulls in black.
Group 2: 3mm pvc edgebanding on top only.
Standard with interlock device, to prevent multiple drawers from being opened at one time.
Standard filing hardware, lateral files:
letter front-to-back; legal side-to-side
Double wide units are standard with locks keyed alike.



phone: (510) 259-6217
email: info@actionlaminates.com

EDGE DETAILS

GROUP A

GROUP B



BASIC ELEMENTS PEDESTALS

	MODEL NUMBER	SIZE	WT.	GROUP A	GROUP B
FLOOR SUPPORT					
		D x W x H			
BBF	399-FS-BBF-18-□	18 x 16 x 27.75	90	822	880
	399-FS-BBF-23-□	23 x 16 x 27.75	95	868	937
	399-FS-BBF-29-□	29 x 16 x 27.75	100	932	989
<hr/>					
FLOOR SUPPORT					
		D x W x H			
FF	399-FS-FF-18-□	18 x 16 x 27.75	90	822	880
	399-FS-FF-23-□	23 x 16 x 27.75	95	868	937
	399-FS-FF-29-□	29 x 16 x 27.75	100	932	989
<hr/>					
MOBILE					
		D x W x H			
BBF	399-M-BBF-18-□	18 x 16 x 27.5	90	932	989
	399-M-BBF-23-□	23 x 16 x 27.5	95	978	1046
	399-M-BBF-29-□	29 x 16 x 27.5	100	1046	1110
<hr/>					
MOBILE					
		D x W x H			
FF	399-M-FF-18-□	18 x 16 x 27.5	90	932	989
	399-M-FF-23-□	23 x 16 x 27.5	95	978	1046
	399-M-FF-29-□	29 x 16 x 27.5	100	1046	1110
<hr/>					
MOBILE					
		D x W x H			
BBB	399-M-BBB-18-□	18 x 16 x 27.5	90	695	765
	399-M-BBB-23-□	23 x 16 x 27.5	95	753	822
	399-M-BBB-29-□	29 x 16 x 27.5	100	822	880
<hr/>					
MOBILE					
		D x W x H			
BF	399-M-BF-18-□	18 x 16 x 22.5	80	695	765
	399-M-BF-23-□	23 x 16 x 22.5	85	753	822
	399-M-BF-29-□	29 x 16 x 22.5	90	822	880
<hr/>					
MOBILE					
		D x W x H			
BF w/ cushion	399-M-BFC-18-□	18 x 16 x 24.5	85	1081	1144
	399-M-BFC-23-□	23 x 16 x 24.5	90	1127	1196
	399-M-BFC-29-□	29 x 16 x 24.5	95	1196	1265

OPTIONS:

Arc pulls in polished chrome or satin chrome, no up charge.
Master key, \$30.
Key-change tool, \$30.

NOTES:

All pedestals are standard with lock.
Standard with Arc Pulls in black.
Floor support pedestals standard with finished back and non-finished top.
Mobile pedestals have finished tops.
Standard filing hardware, pedestals:
letter front-to-back; legal side-to-side
Cushion is wood-backed, w/ French box seams, attached to pedestal. Standard fabric.
Custom fabrics available, consult factory.



phone: (510) 259-6217
email: info@actionlaminates.com

EDGE DETAILS

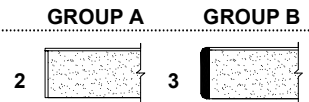

BASIC ELEMENTS FLOOR SUPPORT LATERAL FILE AND FILE CENTER

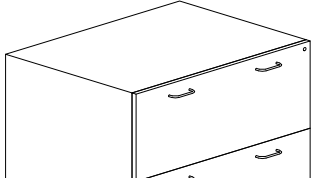
	MODEL NUMBER	SIZE	WT.		GROUP A	GROUP B
FLOOR SUPPORT LATERAL FILE 				Columns of letter size files, front-to-back		
	399-FS-LF-1930-□	19 x 30 x 27.75	135	2	1374	1472
	399-FS-LF-2330-□	23 x 30 x 27.75	145	2	1432	1530
	399-FS-LF-1936-□	19 x 36 x 27.75	155	2	1472	1564
	399-FS-LF-2336-□	23 x 36 x 27.75	165	2	1530	1633
	399-FS-LF-1942-□	19 x 42 x 27.75	175	3	1633	1731
	399-FS-LF-2342-□	23 x 42 x 27.75	185	3	1696	1794

FLOOR SUPPORT FILE CENTER

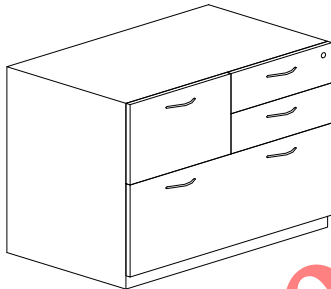

399-FS-FC-1932-□	19 x 32 x 27.75	135	2	1829	1955
399-FS-FC-2332-□	23 x 32 x 27.75	145	2	1926	2053

OPTIONS:

Arc pulls in polished chrome or satin chrome, no upcharge.
Master key, \$30.
Key-change tool, \$30.

FILE CENTER CONFIGURATIONS:

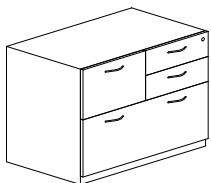

LEFT

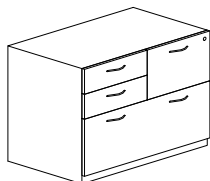

RIGHT

NOTES:

Standard lock on File Center locks drawer(s) at right and lateral drawer.
Standard with Arc Pulls in black.
Standard with finished back and non finished top.
Please specify file center configuration.
Standard filing hardware, lateral files: letter front-to-back; legal side-to-side



phone: (510) 259-6217
email: info@actionlaminates.com

EDGE DETAILS

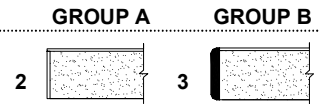

**BASIC ELEMENTS
SUPPORT PEDESTALS**

	MODEL NUMBER	SIZE	WT.	ADJ. SHELVES	GROUP A	GROUP B
SINGLE HINGED DOOR						
		D x W x H				
	399-□-FS-HD-1816-□	18 x 16 x 27.75	65	1	564	627
	399-□-FS-HD-2316-□	23 x 16 x 27.75	80	1	690	759
	399-□-FS-HD-1824-□	18 x 24 x 27.75	80	1	690	759
	399-□-FS-HD-2324-□	23 x 24 x 27.75	96	1	822	903
DOUBLE HINGED DOORS						
	399-FS-HD-1830-□	18 x 30 x 27.75	94	1	811	886
	399-FS-HD-2330-□	23 x 30 x 27.75	113	1	960	1058
	399-FS-HD-1836-□	18 x 36 x 27.75	108	1	932	1018
	399-FS-HD-2336-□	23 x 36 x 27.75	129	1	1093	1208
OPEN CUBBIES						
				COLUMNS x ROWS		
	335-FS-CU-2930-□	29 x 30 x 27.75	225	5 x 4	1875	2070
	335-FS-CU-2936-□	29 x 36 x 27.75	266	6 X 4	2214	2438
	335-FS-CU-2942-□	29 x 42 x 27.75	308	7 X 4	2565	2818
	335-FS-CU-2948-□	29 x 48 x 27.75	349	8 X 4	2904	3197
	335-FS-CU-3530-□	35 x 30 x 27.75	266	5 x 4	2214	2438
	335-FS-CU-3536-□	35 x 36 x 27.75	315	6 X 4	2622	2887
	335-FS-CU-3542-□	35 x 42 x 27.75	364	7 X 4	3025	3329
	335-FS-CU-3548-□	35 x 48 x 27.75	413	8 X 4	3433	3778

Options

- Single door lock add \$50 list.
- Lock for pair of doors, add \$70 list.
- Arc pulls in polished chrome or satin chrome, no upcharge.
- Master key, \$30.
- Key-change tool, \$30.

NOTES:

- Single door units, specify hinge at left or right: add "L" or "R" after "399" in model number.
- Standard with Arc Pulls in black.
- Standard with finished back and non-finished top.
- Pedestal with doors, standard with one adjustable shelf.
- Please specify edge detail at end of the model number.
- Cubbie pedestal standard with fixed opening dimension.



phone: (510) 259-6217
 email: info@actionlaminates.com

EDGE DETAILS

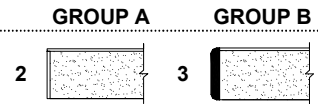

BASIC ELEMENTS

OPEN BOOKCASES, 12" DEEP

MODEL NUMBER	SIZE	WT.	Adjustable Shelves	GROUP A	GROUP B
	D x W x H				
335-2429-	12 x 24 x 29	48	1	426	466
335-2436-	12 x 24 x 36	54	1	477	523
335-2448-	12 x 24 x 48	72	2	633	702
335-2460-	12 x 24 x 60	90	3	788	868
335-2472-	12 x 24 x 72	108	4	949	1047
335-2484-	12 x 24 x 84	126	5	1110	1219
335-2496-	12 x 24 x 96	144	6	1265	1392
Extra Shelf, 12"d x 24"w, add \$50 List Price.					
335-3029-	12 x 30 x 29	56	1	500	546
335-3036-	12 x 30 x 36	63	1	552	615
335-3048-	12 x 30 x 48	84	2	736	811
335-3060-	12 x 30 x 60	105	3	926	1006
335-3072-	12 x 30 x 72	126	4	1110	1219
335-3084-	12 x 30 x 84	147	5	1294	1420
335-3096-	12 x 30 x 96	168	6	1478	1622
Extra Shelf, 12"d x 30"w, add \$69 List Price.					
335-3629-	12 x 36 x 29	65	1	564	627
335-3636-	12 x 36 x 36	72	1	633	702
335-3648-	12 x 36 x 48	96	2	845	932
335-3660-	12 x 36 x 60	120	3	1058	1162
335-3672-	12 x 36 x 72	144	4	1265	1392
335-3684-	12 x 36 x 84	168	5	1478	1622
335-3696-	12 x 36 x 96	192	6	1691	1857
Extra Shelf, 12"d x 36"w, add \$81 List Price.					
335-6029-	12 x 60 x 29	103	2	909	995
335-7229-	12 x 72 x 29	119	2	1058	1156
335-6036-	12 x 60 x 36	117	2	1029	1133
335-7236-	12 x 72 x 36	135	2	1190	1305
335-6048-	12 x 60 x 48	156	4	1374	1507
335-7248-	12 x 72 x 48	180	4	1581	1737
Extra Shelf, 12"d x 30"w, add \$69 List Price.					
Extra Shelf, 12"d x 36"w, add \$81 List Price.					

OPTIONS:

See laminate door options, page 97.
 See glass door options, page 98-99

NOTES:

7/8" thick construction.
 Please specify edge detail at the end of the model number.
 Standard with finished back.



phone: (510) 259-6217
 email: info@actionlaminates.com

EDGE DETAILS

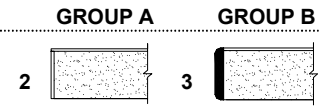

BASIC ELEMENTS
OPEN BOOKCASES, 15" DEEP

MODEL NUMBER	SIZE	WT.	Adjustable Shelves	GROUP A	GROUP B
	D x W x H				
336-2429- <input type="checkbox"/>	15 x 24 x 29	59	1	518	564
336-2436- <input type="checkbox"/>	15 x 24 x 36	66	1	581	638
336-2448- <input type="checkbox"/>	15 x 24 x 48	88	2	771	851
336-2460- <input type="checkbox"/>	15 x 24 x 60	110	3	966	1064
336-2472- <input type="checkbox"/>	15 x 24 x 72	132	4	1162	1282
336-2484- <input type="checkbox"/>	15 x 24 x 84	154	5	1351	1489
336-2496- <input type="checkbox"/>	15 x 24 x 96	176	6	1547	1702
Extra Shelf, 15"d x 24"w, add \$69 List Price.					
336-3029- <input type="checkbox"/>	15 x 30 x 29	69	1	610	667
336-3036- <input type="checkbox"/>	15 x 30 x 36	77	1	673	736
336-3048- <input type="checkbox"/>	15 x 30 x 48	102	2	891	983
336-3060- <input type="checkbox"/>	15 x 30 x 60	128	3	1121	1231
336-3072- <input type="checkbox"/>	15 x 30 x 72	153	4	1340	1484
336-3084- <input type="checkbox"/>	15 x 30 x 84	179	5	1564	1725
336-3096- <input type="checkbox"/>	15 x 30 x 96	204	6	1794	1972
Extra Shelf, 15"d x 30"w, add \$81 List Price.					
336-3629- <input type="checkbox"/>	15 x 36 x 29	79	1	690	765
336-3636- <input type="checkbox"/>	15 x 36 x 36	87	1	765	845
336-3648- <input type="checkbox"/>	15 x 36 x 48	116	2	1018	1121
336-3660- <input type="checkbox"/>	15 x 36 x 60	145	3	1271	1403
336-3672- <input type="checkbox"/>	15 x 36 x 72	174	4	1524	1673
336-3684- <input type="checkbox"/>	15 x 36 x 84	203	5	1783	1955
336-3696- <input type="checkbox"/>	15 x 36 x 96	232	6	2036	2237
Extra Shelf, 15"d x 36"w, add \$98 List Price.					
336-6029- <input type="checkbox"/>	15 x 60 x 29	120	2	1104	1213
336-7229- <input type="checkbox"/>	15 x 72 x 29	138	2	1271	1403
336-6036- <input type="checkbox"/>	15 x 60 x 36	135	2	1242	1369
336-7236- <input type="checkbox"/>	15 x 72 x 36	155	2	1420	1570
336-6048- <input type="checkbox"/>	15 x 60 x 48	180	4	1650	1817
336-7248- <input type="checkbox"/>	15 x 72 x 48	207	4	1898	2093

OPTIONS:

See laminate door options, page 97.
 See glass door options, page 98-99.

NOTES:

7/8" thick construction.
 Please specify edge detail at the end of the model number.
 Standard with finished back.



phone: (510) 259-6217
email: info@actionlaminates.com

EDGE DETAILS

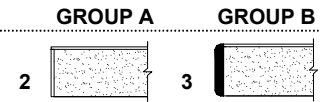

BASIC ELEMENTS

FULL OVERLAY HINGED DOORS

		W x H	WT.	Hinges per door	GROUP A	GROUP B
Laminate Doors						
SINGLE DOOR						
	337-□-2429-□	24 x 27	14	2	161	173
	337-□-2436-□	24 x 34	17	2	184	201
	337-□-2448-□	24 x 46	23	3	242	265
	337-□-2460-□	24 x 58	29	3	293	334
	337-□-2472-□	24 x 70	35	3	351	397
	337-□-2484-□	24 x 82	41	4	460	529
	337-□-2496-□	24 x 94	47	4	460	529
SIZE PER PAIR						
	337-3029- □	30 x 27	17	2	184	201
	337-3036- □	30 x 34	21	2	213	230
	337-3048- □	30 x 46	29	3	282	316
	337-3060- □	30 x 58	36	3	351	397
	337-3072- □	30 x 70	44	3	420	477
	337-3084- □	30 x 82	51	4	558	644
	337-3096- □	30 x 94	59	4	558	644
	337-3629- □	36 x 27	20	2	213	230
	337-3636- □	36 x 34	26	2	253	282
	337-3648- □	36 x 46	35	3	339	380
	337-3660- □	36 x 58	44	3	420	477
	337-3672- □	36 x 70	53	3	506	581
	337-3684- □	36 x 82	62	4	673	776
	337-3696- □	36 x 94	71	4	673	776

OPTIONS:
Arc pulls in polished chrome or satin chrome, no upcharge.
Double door lock add \$70 list.
Note: Double door lock requires shelf at 29" high to be fixed height.
Master key, \$30.
Key-change tool, \$30.

NOTES:
Single doors: please specify hinge at left or right,
Please specify edge detail at the end of the
model number.
Standard with Arc Pulls in black.



phone: (510) 259-6217
email: info@actionlaminates.com

EDGE DETAILS

GROUP A

GROUP B

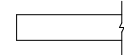

Flat Polish

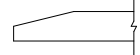

1" Bevel

BASIC ELEMENTS

FULL OVERLAY HINGED DOORS

	W x H	WT.	Hinges per door	GROUP A	GROUP B	
Glass Doors, no frame						
SINGLE DOOR						
	313-□-2429-□	24 x 27	14	2	492	516
	313-□-2436-□	24 x 34	18	2	534	552
	313-□-2448-□	24 x 46	25	3	678	708
	313-□-2460-□	24 x 58	31	3	750	786
	313-□-2472-□	24 x 70	37	3	828	870
	313-□-2484-□	24 x 82	44	4	972	1020
	313-□-2496-□	24 x 94	50	4	1050	1104
SIZE PER PAIR						
	313-3029-□	30 x 27	18	2	870	912
	313-3036-□	30 x 34	23	2	930	972
	313-3048-□	30 x 46	31	3	1194	1248
	313-3060-□	30 x 58	39	3	1314	1380
	313-3072-□	30 x 70	47	3	1428	1506
	313-3084-□	30 x 82	55	4	1692	1782
	313-3096-□	30 x 94	63	4	1806	1914
		313-3629-□	36 x 27	22	2	894
313-3636-□		36 x 34	27	2	960	1008
313-3648-□		36 x 46	37	3	1230	1290
313-3660-□		36 x 58	46	3	1362	1428
313-3672-□		36 x 70	56	3	1482	1566
313-3684-□		36 x 82	66	4	1752	1848
313-3696-□		36 x 94	75	4	1878	1980

OPTIONS:

- Other colors of glass available, please consult factory.
- Patterned glass available, please consult factory.
- Arc pulls in polished chrome or satin chrome, no upcharge.
- Double door lock add \$70 list.
- Note: Double door lock requires shelf at 29" high to be fixed height.
- Master key, \$30.
- Key-change tool, \$30.

NOTES:

- Standard is 1/4" thick clear, tempered glass.
- Standard with Arc Pulls in black.
- Single doors: please specify hinge at left or right, add "L" or "R" after "313" in model number
- Please specify edge detail at the end of the model number.



phone: (510) 259-6217
 email: info@actionlaminates.com

EDGE DETAILS

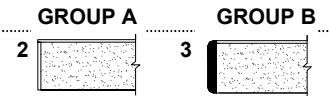

BASIC ELEMENTS
FULL OVERLAY HINGED DOORS

	W x H	WT.	Hinges per door	GROUP A	GROUP B
Glass Doors, with laminate frame					
SINGLE DOOR					
314-□-2429- □	24 x 27	22	2	432	462
314-□-2436- □	24 x 34	27	2	498	522
314-□-2448- □	24 x 46	37	3	624	654
314-□-2460- □	24 x 58	46	3	768	816
314-□-2472- □	24 x 70	56	3	882	936
314-□-2484- □	24 x 82	66	4	1068	1140
314-□-2496- □	24 x 94	75	4	1122	1200
SIZE PER PAIR					
314-3029- □	30 x 27	27	2	540	570
314-3036- □	30 x 34	34	2	612	648
314-3048- □	30 x 46	46	3	780	822
314-3060- □	30 x 58	58	3	984	1044
314-3072- □	30 x 70	70	3	1134	1200
314-3084- □	30 x 82	82	4	1380	1470
314-3096- □	30 x 94	94	4	1500	1590
SIZE PER PAIR					
314-3629- □	36 x 27	32	2	594	630
314-3636- □	36 x 34	41	2	690	732
314-3648- □	36 x 46	55	3	876	930
314-3660- □	36 x 58	70	3	1170	1242
314-3672- □	36 x 70	84	3	1320	1398
314-3684- □	36 x 82	98	4	1572	1686
314-3696- □	36 x 94	113	4	1662	1776

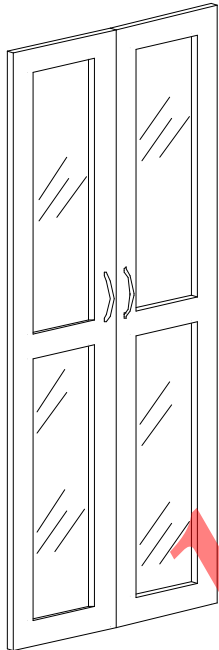
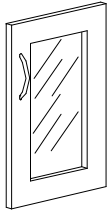

OPTIONS:

- Other colors of glass available, please consult factory.
- Patterned glass available, please consult factory.
- Arc pulls in polished chrome or satin chrome, no upcharge.
- Double door lock add \$70 list.
- Note: Double door lock requires shelf at 29" high to be fixed height.
- Master key, \$30.
- Key-change tool, \$30.

NOTES:

- Standard is 1/4" thick clear, tempered glass.
- Standard with 3" wide laminate frame.
- Standard with Arc Pulls in black.
- Single doors: please specify hinge at left or right, add "L" or "R" after "314" in model number
- Standard 60"h - 96"h is a two-panel glass door.
- Please specify edge detail at the end of the model number.



phone: (510) 259-6217
email: info@actionlaminates.com

EDGE DETAILS

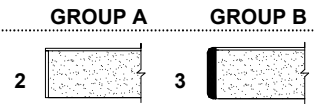

**BASIC ELEMENTS
WARDROBE CABINETS**

	MODEL NUMBER	SIZE D x W x H	WT.	Shelves	GROUP A	GROUP B
SINGLE DOOR						
	317-□-1872-□	24 x 18 x 72	162	2	1581	1731
	317-□-1884-□	24 x 18 x 84	183	2	1765	1938
	317-□-1896-□	24 x 18 x 96	204	2	1955	2145
	317-□-2472-□	24 x 24 x 72	192	2	1846	2024
	317-□-2484-□	24 x 24 x 84	216	2	2070	2271
	317-□-2496-□	24 x 24 x 96	240	2	2289	2513
DOUBLE DOOR						
	317-3072-□	24 x 30 x 72	222	2	2128	2335
	317-3084-□	24 x 30 x 84	249	2	2375	2605
	317-3096-□	24 x 30 x 96	276	2	2628	2887
	317-3672-□	24 x 36 x 72	252	2	2398	2634
	317-3684-□	24 x 36 x 84	282	2	2685	2938
	317-3696-□	24 x 36 x 96	312	2	2961	3249

Additively effective
10% effective
7/1/2024

OPTIONS:

Lock for single door, add \$50 List.
Lock for double door cabinet, not available.

NOTES:

7/8" thick construction with full overlay doors.
Standard with one fixed height shelf 12" below top.
Standard with one adjustable shelf at bottom.
Standard with polished chrome clothing rod 3" below fixed height shelf.
Please specify left or right hinge on single door units:
add "L" or "R" after "317" in model number.
Please specify edge detail at the end of the model number.
Standard with finished back.

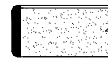
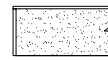

phone: (510) 259-6217
email: info@actionlaminates.com

BASIC ELEMENTS STORAGE CABINETS, 18" DEEP

	MODEL NUMBER	SIZE D x W x H	WT.	Adjustable Shelves	GROUP A	GROUP B
SINGLE DOOR						
	315-□-1829-□	18 x 18 x 29	65	1	610	667
	315-□-1836-□	18 x 18 x 36	74	1	684	759
	315-□-1848-□	18 x 18 x 48	99	2	909	1001
	315-□-1860-□	18 x 18 x 60	124	3	1150	1265
	315-□-1872-□	18 x 18 x 72	142	3	1311	1438
	315-□-1884-□	18 x 18 x 84	167	4	1541	1696
	315-□-1896-□	18 x 18 x 96	185	4	1708	1875
Extra Shelf, 18"d x 18"w, add \$63 List Price.						
	315-□-2429-□	18 x 24 x 29	80	1	736	811
	315-□-2436-□	18 x 24 x 36	90	1	840	926
	315-□-2448-□	18 x 24 x 48	120	2	1110	1219
	315-□-2460-□	18 x 24 x 60	150	3	1392	1524
	315-□-2472-□	18 x 24 x 72	171	3	1587	1742
	315-□-2484-□	18 x 24 x 84	201	4	1857	2047
	315-□-2496-□	18 x 24 x 96	222	4	2053	2266
Extra Shelf, 18"d x 24"w, add \$81 List Price						
DOUBLE DOOR						
	315-3029-□	18 x 30 x 29	94	1	868	955
	315-3036-□	18 x 30 x 36	106	1	978	1075
	315-3048-□	18 x 30 x 48	141	2	1305	1432
	315-3060-□	18 x 30 x 60	176	3	1633	1794
	315-3072-□	18 x 30 x 72	200	3	1852	2036
	315-3084-□	18 x 30 x 84	236	4	2179	2392
	315-3096-□	18 x 30 x 96	260	4	2398	2639
Extra Shelf, 18"d x 30"w, add \$98 List Price						
	315-3629-□	18 x 36 x 29	108	1	995	1093
	315-3636-□	18 x 36 x 36	122	1	1121	1231
	315-3648-□	18 x 36 x 48	162	2	1501	1650
	315-3660-□	18 x 36 x 60	203	3	1869	2059
	315-3672-□	18 x 36 x 72	230	3	2128	2346
	315-3684-□	18 x 36 x 84	270	4	2496	2743
	315-3696-□	18 x 36 x 96	297	4	2743	3019
Extra Shelf, 18"d x 36"w, add \$115 List Price						

OPTIONS:

Lock add \$50 List for single door.
Lock add \$70 List for double doors.
Note: Double door lock requires shelf at 29" high to be fixed height.

NOTES:

7/8" thick construction with full overlay doors.
Units up to 48" high have 1-1/4" thick top overhanging doors.
Please specify left or right hinge on single door units:
add "L" or "R" after "315" in model number.
Please specify edge detail at the end of the model number.
Standard with finished back.



phone: (510) 259-6217
email: info@actionlaminates.com

EDGE DETAILS

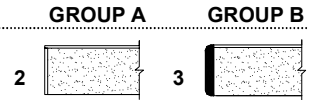

**BASIC ELEMENTS
STORAGE CABINETS, 24" DEEP**

	MODEL NUMBER	SIZE D x W x H	WT.	Adjustable Shelves	GROUP A	GROUP B
SINGLE DOOR						
	316-□-1829-□	24 x 18 x 29	80	1	736	811
	316-□-1836-□	24 x 18 x 36	90	1	840	926
	316-□-1848-□	24 x 18 x 48	120	2	1110	1219
	316-□-1860-□	24 x 18 x 60	150	3	1392	1524
	316-□-1872-□	24 x 18 x 72	171	3	1587	1742
	316-□-1884-□	24 x 18 x 84	201	4	1857	2047
	316-□-1896-□	24 x 18 x 96	222	4	2053	2266
	Extra Shelf, 24"d x 18"w, add \$81 List Price.					
	316-□-2429-□	24 x 24 x 29	96	1	886	978
	316-□-2436-□	24 x 24 x 36	108	1	995	1093
	316-□-2448-□	24 x 24 x 48	144	2	1328	1466
	316-□-2460-□	24 x 24 x 60	180	3	1662	1829
	316-□-2472-□	24 x 24 x 72	204	3	1880	2076
	316-□-2484-□	24 x 24 x 84	240	4	2214	2438
	316-□-2496-□	24 x 24 x 96	264	4	2438	2685
	Extra Shelf, 24"d x 24"w, add \$104 List Price.					
DOUBLE DOOR						
	316-3029-□	24 x 30 x 29	113	1	1041	1144
	316-3036-□	24 x 30 x 36	126	1	1167	1288
	316-3048-□	24 x 30 x 48	168	2	1553	1708
	316-3060-□	24 x 30 x 60	210	3	1944	2139
	316-3072-□	24 x 30 x 72	237	3	2191	2409
	316-3084-□	24 x 30 x 84	279	4	2582	2841
	316-3096-□	24 x 30 x 96	306	4	2829	3111
	Extra Shelf, 24"d x 30"w, add \$138 List Price.					
	316-3629-□	24 x 36 x 29	129	1	1196	1311
	316-3636-□	24 x 36 x 36	144	1	1328	1466
	316-3648-□	24 x 36 x 48	192	2	1771	1949
	316-3660-□	24 x 36 x 60	240	3	2214	2438
	316-3672-□	24 x 36 x 72	270	3	2496	2743
	316-3684-□	24 x 36 x 84	318	4	2938	3237
	316-3696-□	24 x 36 x 96	348	4	3226	3542
	Extra Shelf, 24"d x 36"w, add \$161 List Price.					

OPTIONS:

Lock add \$50 List for single door.
Lock add \$70 List for double doors.
Note: Double door lock requires shelf at 29" high to be fixed height.

NOTES:

7/8" thick construction with full overlay doors.
Units up to 48" high have 1-1/4" thick top overhanging doors.
Please specify left or right hinge on single door units:
add "L" or "R" after "316" in model number.
Please specify edge detail at the end of the model number.
Standard with finished back.



phone: (510) 259-6217
email: info@actionlaminates.com

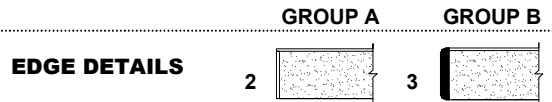

BASIC ELEMENTS OPEN CUBBIES

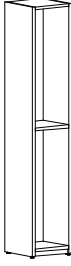
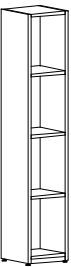
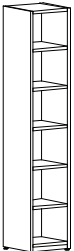
	MODEL NUMBER	SIZE D x W x H	WT.	COLUMNS	OPENINGS	GROUP A	GROUP B
SINGLE OPENING COLUMN							
	339-1272- ☐	12 x 12 x 72	60	1	1	529	592
	339-2472- ☐	12 x 24 x 72	105	2	2	897	1001
	339-4872- ☐	12 x 48 x 72	190	4	4	1633	1823
	339-7272- ☐	12 x 72 x 72	270	6	6	2369	2645
TWO OPENING COLUMN							
	340-1272- ☐	12 x 12 x 72	65	1	2	552	621
	340-2472- ☐	12 x 24 x 72	110	2	4	949	1058
	340-4872- ☐	12 x 48 x 72	200	4	8	1742	1938
	340-7272- ☐	12 x 72 x 72	290	6	12	2530	2818
FOUR OPENING COLUMN							
	341-1272- ☐	12 x 12 x 72	70	1	4	610	679
	341-2472- ☐	12 x 24 x 72	120	2	8	1058	1173
	341-4872- ☐	12 x 48 x 72	225	4	16	1949	2174
	341-7272- ☐	12 x 72 x 72	325	6	24	2846	3168
SIX OPENING COLUMN							
	342-1272- ☐	12 x 12 x 72	75	1	6	656	736
	342-2472- ☐	12 x 24 x 72	135	2	12	1162	1294
	342-4872- ☐	12 x 48 x 72	250	4	24	2162	2404
	342-7272- ☐	12 x 72 x 72	360	6	36	3163	3519

OPTIONS:

- Single wardrobe hook, add \$8 List.
- Double wardrobe hook, add \$10 List.
- 1-5/16" dia polished chrome clothing rod, add \$40 List.
- Add 18% for 15" deep.
- Add 36% for 18" deep.
- Add 72% for 24" deep.
- For custom dimensions, please consult factory.

NOTES:

- 7/8" thick construction.
- Please specify edge detail at the end of the model number.
- Standard with finished back.
- Standard with 1-1/4" high toe kick.

BASIC ELEMENTS LOCKERS

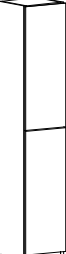
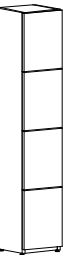
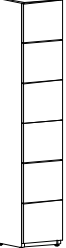
	MODEL NUMBER	SIZE	WT.	COLUMNS	OPENINGS	GROUP A	GROUP B
	D x W x H						
SINGLE DOOR COLUMN							
	343-□-1272-□	12 x 12 x 72	80	1	1	765	840
	343-□-2472-□	12 x 24 x 72	140	2	2	1357	1495
	343-□-4872-□	12 x 48 x 72	260	4	4	2559	2818
	343-□-7272-□	12 x 72 x 72	380	6	6	3761	4140
TWO DOOR COLUMN							
	344-□-1272-□	12 x 12 x 72	80	1	2	811	891
	344-□-2472-□	12 x 24 x 72	145	2	4	1461	1604
	344-□-4872-□	12 x 48 x 72	270	4	8	2760	3042
	344-□-7272-□	12 x 72 x 72	395	6	12	4065	4474
FOUR DOOR COLUMN							
	345-□-1272-□	12 x 12 x 72	90	1	4	960	1058
	345-□-2472-□	12 x 24 x 72	160	2	8	1765	1938
	345-□-4872-□	12 x 48 x 72	295	4	16	3370	3703
	345-□-7272-□	12 x 72 x 72	435	6	24	4974	5468
SIX DOOR COLUMN							
	346-□-1272-□	12 x 12 x 72	95	1	6	1116	1225
	346-□-2472-□	12 x 24 x 72	170	2	12	2070	2271
	346-□-4872-□	12 x 48 x 72	320	4	24	3973	4370
	346-□-7272-□	12 x 72 x 72	470	6	36	5882	6475

OPTIONS:

Single wardrobe hook, add \$8 List.
 Double wardrobe hook, add \$10 List.
 1-5/16" dia polished chrome clothing rod, add \$50 List.
 Add 10% for 15" deep.
 Add 20% for 18" deep.
 Add 40% for 24" deep.
 For custom dimensions, please consult factory.

NOTES:

Lock not included; see locks page 105.
 7/8" thick construction with full overlay doors.
 Please specify left or right hinges; add "L" or "R" after model number.
 Please specify edge detail at the end of the model number.
 Standard with finished back.
 Standard with 1-1/4" high toe kick.

BASIC ELEMENTS LOCKER LOCKS

	MODEL NUMBER	DESCRIPTION	FINISH	LIST PRICE
KEY CAM LOCK				
	LOCK - 1	Standard key lock. For single door application. Supplied with 2 keys	Black, Polished Chrome, Satin Chrome, Nickel Matte	50
PADLOCK HASP				
	LOCK - 2	The Hasp Cam lock is a two piece lock set used with a padlock to secure the locker door. **Please note: padlock not included.	Chrome	50
ELECTRONIC LOCK				
	LOCK - 3	Electronic lock, easily programs for private or public functionality. 15,000 openings from 2 AAA batteries supplied. Low battery warning. Memory retains setting when batteries are changed. Vertical mount.	Silver Grey	286
ELECTRONIC LOCK				
	LOCK - 4	Electronic keypad for entering 4-7 digit code, or by an ADA compliant User Key. For either shared use functionality to secure day-use storage or assigned use functionality for private storage. Includes electric deadbolt mechanism and batteries. NOTE: Requires (1) Programmer's Key per Set of Locks. (see below) Requires at least (1) Manager's Key per Set of Locks, up to (25) keys. (see below). OPTIONS: Available in Black, no additional charge. Please consult factory for additional options.	Brushed Nickel	382
PROGRAMMER KEY				
	KEY - 1	Programmer's Key for Lock - 4, above. Allows set-up of locks and assigning either shared or assigned use functionality. Registers manager's keys to individual locks.	Yellow	117
MANAGER KEY				
	KEY - 2	Manager's Key for Lock - 4, above. Allows override of locks registered to key, and power in battery outage.	Black	88

OPTIONS:

Other locks available, please consult factory.



phone: (510) 259-6217
email: info@actionlaminates.com

EDGE DETAILS

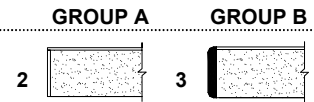

BASIC ELEMENTS

WALL MOUNT UPPER CABINET, 12" DEEP X 24" HIGH

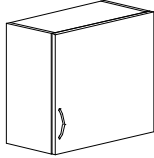
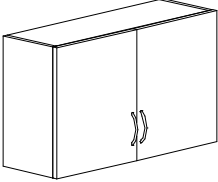
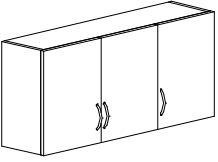
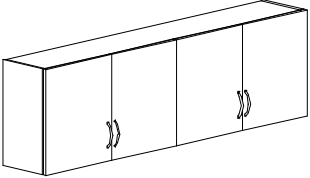
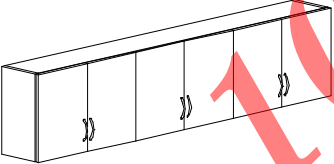
	MODEL NUMBER	SIZE	WT.	ADJ. SHELVES	GROUP A	GROUP B
D x W x H						
ONE DOOR						
	318-□-2424-□	12 x 24 x 24	54	1	506	552
	Extra Shelf, 12"d x 24"w, add \$58 List Price.					
TWO DOORS						
	318-3024-□	12 x 30 x 24	65	1	598	650
	318-3624-□	12 x 36 x 24	75	1	690	765
	Extra Shelf, 12"d x 30"w, add \$69 List Price.					
	Extra Shelf, 12"d x 36"w, add \$81 List Price.					
THREE DOORS						
	318-□-4224-□	12 x 42 x 24	92	2	851	937
	318-□-4824-□	12 x 48 x 24	102	2	949	1047
	Extra Shelf, 12"d x 28"w, add \$69 List Price.					
	Extra Shelf, 12"d x 32"w, add \$81 List Price.					
FOUR DOORS						
	318-6024-□	12 x 60 x 24	123	2	1139	1242
	318-7224-□	12 x 72 x 24	144	2	1328	1461
	Extra Shelf, 12"d x 30"w, add \$69 List Price.					
	Extra Shelf, 12"d x 36"w, add \$81 List Price.					
SIX DOORS						
	318-8424-□	12 x 84 x 24	171	3	1587	1742
	318-9624-□	12 x 96 x 24	192	3	1771	1949
	Extra Shelf, 12"d x 28"w, add \$69 List Price.					
	Extra Shelf, 12"d x 32"w, add \$81 List Price.					

OPTIONS:

- Single door lock add \$50 list.
- Lock for pair of doors, add \$70 list.
- Arc pulls in polished chrome or satin chrome, no upcharge.
- Master key, \$30.
- Key-change tool, \$30.
- Scribes 1-1/2"w add \$45 per side.
- Flush bottom (no fascia), no upcharge.
- Task light not included; see accessories page 119.

NOTES:

- Single door units, specify hinge at left or right:
add "L" or "R" after "318" in model number.
- Three door units, specify single door at left or right:
add "L" or "R" after "318" in model number.
- Please specify edge detail at the end of the model number.
- Standard with Arc Pulls in black.
- Standard with recessed back and wall cleat.
- Standard with task light fascia.



phone: (510) 259-6217
email: info@actionlaminates.com

EDGE DETAILS

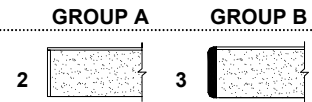

BASIC ELEMENTS

WALL MOUNT UPPER CABINET, 12" DEEP X 30" HIGH

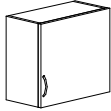
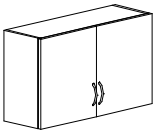
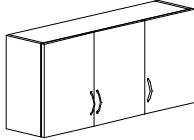
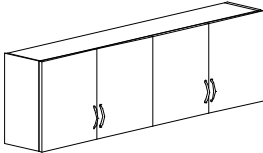
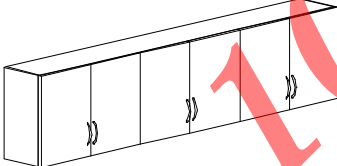
	MODEL NUMBER	SIZE	WT.	ADJ. SHELVES	GROUP A	GROUP B
ONE DOOR						
	318-□-2430-□	12 x 24 x 30	69	1	581	638
	Extra Shelf, 12"d x 24"w, add \$58 List Price.					
TWO DOORS						
	318-3030-□	12 x 30 x 30	83	1	690	765
	318-3630-□	12 x 36 x 30	96	1	799	880
	Extra Shelf, 12"d x 30"w, add \$69 List Price.					
	Extra Shelf, 12"d x 36"w, add \$81 List Price.					
THREE DOORS						
	318-□-4230-□	12 x 42 x 30	117	2	983	1081
	318-□-4830-□	12 x 48 x 30	131	2	1093	1208
	Extra Shelf, 12"d x 28"w, add \$69 List Price.					
	Extra Shelf, 12"d x 32"w, add \$81 List Price.					
FOUR DOORS						
	318-6030-□	12 x 60 x 30	158	2	1317	1599
	318-7230-□	12 x 72 x 30	185	2	1541	1875
	Extra Shelf, 12"d x 30"w, add \$69 List Price.					
	Extra Shelf, 12"d x 36"w, add \$81 List Price.					
SIX DOORS						
	318-8430-□	12 x 84 x 30	219	3	1834	2018
	318-9630-□	12 x 96 x 30	246	3	2053	2266
	Extra Shelf, 12"d x 28"w, add \$69 List Price.					
	Extra Shelf, 12"d x 32"w, add \$81 List Price.					

OPTIONS:

- Single door lock add \$50 list.
- Lock for pair of doors, add \$70 list.
- Arc pulls in polished chrome or satin chrome, no upcharge.
- Master key, \$30.
- Key-change tool, \$30.
- Scribes 1-1/2"w add \$45 per side.
- Flush bottom (no fascia), no upcharge.
- Task light not included; see accessories page 119.

NOTES:

- Single door units, specify hinge at left or right:
add "L" or "R" after "318" in model number.
- Three door units, specify single door at left or right:
add "L" or "R" after "318" in model number.
- Please specify edge detail at the end of the model number.
- Standard with Arc Pulls in black.
- Standard with recessed back and wall cleat.
- Standard with task light fascia.



phone: (510) 259-6217
email: info@actionlaminates.com

EDGE DETAILS

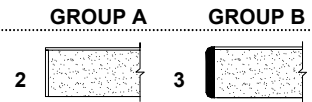

BASIC ELEMENTS

WALL MOUNT UPPER CABINET, 12" DEEP X 36" HIGH

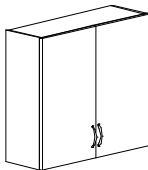
	MODEL NUMBER	SIZE	WT.	ADJ. SHELVES	GROUP A	GROUP B
ONE DOOR						
	318-□-2436-□	12 x 24 x 36	84	2	673	742
	Extra Shelf, 12"d x 24"w, add \$58 List Price.					
TWO DOORS						
	318-3036-□	12 x 30 x 36	101	2	805	886
	318-3636-□	12 x 36 x 36	117	2	932	1024
	Extra Shelf, 12"d x 30"w, add \$69 List Price.					
	Extra Shelf, 12"d x 36"w, add \$81 List Price.					
THREE DOORS						
	318-□-4236-□	12 x 42 x 36	143	4	1139	1254
	318-□-4836-□	12 x 48 x 36	159	4	1277	1403
	Extra Shelf, 12"d x 28"w, add \$69 List Price.					
	Extra Shelf, 12"d x 32"w, add \$81 List Price.					
FOUR DOORS						
	318-6036-□	12 x 60 x 36	192	4	1530	1685
	318-7236-□	12 x 72 x 36	225	4	1794	1967
	Extra Shelf, 12"d x 30"w, add \$69 List Price.					
	Extra Shelf, 12"d x 36"w, add \$81 List Price.					
SIX DOORS						
	318-8436-□	12 x 84 x 36	267	6	2128	2340
	318-9636-□	12 x 96 x 36	300	6	2392	2628
	Extra Shelf, 12"d x 28"w, add \$69 List Price.					
	Extra Shelf, 12"d x 32"w, add \$81 List Price.					

OPTIONS:

- Single door lock add \$50 list.
- Lock for pair of doors, add \$70 list.
- Arc pulls in polished chrome or satin chrome, no upcharge.
- Master key, \$30.
- Key-change tool, \$30.
- Scribes 1-1/2"w add \$45 per side.
- Flush bottom (no fascia), no upcharge.
- Task light not included; see accessories page 119.

NOTES:

- Single door units, specify hinge at left or right:
add "L" or "R" after "318" in model number.
- Three door units, specify single door at left or right:
add "L" or "R" after "318" in model number.
- Please specify edge detail at the end of the model number.
- Standard with Arc Pulls in black.
- Standard with recessed back and wall cleat.
- Standard with task light fascia.



phone: (510) 259-6217
 email: info@actionlaminates.com

EDGE DETAILS

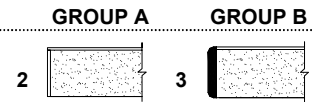

BASIC ELEMENTS

WALL MOUNT UPPER CABINET, 15" DEEP X 24" HIGH

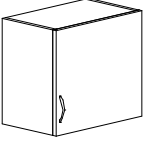
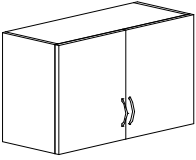
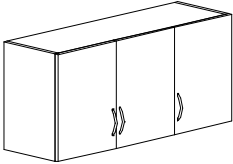
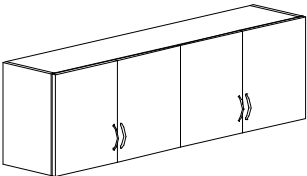
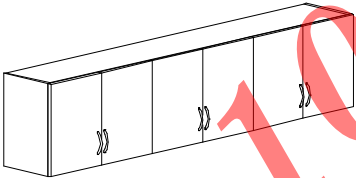
	MODEL NUMBER	SIZE	WT.	ADJ. SHELVES	GROUP A	GROUP B
ONE DOOR						
	319-□-2424-□	15 x 24 x 24	64	1	592	650
Extra Shelf, 15"d x 24"w, add \$75 List Price.						
TWO DOORS						
	319-3024-□	15 x 30 x 24	76	1	702	776
	319-3624-□	15 x 36 x 24	88	1	817	897
Extra Shelf, 15"d x 30"w, add \$92 List Price.						
Extra Shelf, 15"d x 36"w, add \$110 List Price.						
THREE DOORS						
	319-□-4224-□	15 x 42 x 24	108	2	995	1093
	319-□-4824-□	15 x 48 x 24	120	2	1110	1219
Extra Shelf, 15"d x 28"w, add \$92 List Price.						
Extra Shelf, 15"d x 32"w, add \$110 List Price.						
FOUR DOORS						
	319-6024-□	15 x 60 x 24	144	2	1328	1461
	319-7224-□	15 x 72 x 24	168	2	1553	1708
Extra Shelf, 15"d x 30"w, add \$92 List Price.						
Extra Shelf, 15"d x 36"w, add \$110 List Price.						
SIX DOORS						
	319-8424-□	15 x 84 x 24	200	3	1852	2036
	319-9624-□	15 x 96 x 24	224	3	2076	2283
Extra Shelf, 15"d x 28"w, add \$92 List Price.						
Extra Shelf, 15"d x 32"w, add \$110 List Price.						

OPTIONS:

- Single door lock add \$50 list.
- Lock for pair of doors, add \$70 list.
- Arc pulls in polished chrome or satin chrome, no upcharge.
- Master key, \$30.
- Key-change tool, \$30.
- Scribes 1-1/2"w add \$45 per side.
- Flush bottom (no fascia), no upcharge.
- Task light not included; see accessories page 119.

NOTES:

- Single door units, specify hinge at left or right:
add "L" or "R" after "319" in model number.
- Three door units, specify single door at left or right:
add "L" or "R" after "319" in model number.
- Please specify edge detail at the end of the model number.
- Standard with Arc Pulls in black.
- Standard with recessed back and wall cleat.
- Standard with task light fascia.



phone: (510) 259-6217
email: info@actionlaminates.com

EDGE DETAILS

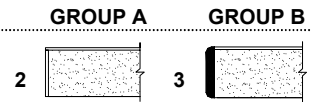

BASIC ELEMENTS

WALL MOUNT UPPER CABINET, 15" DEEP X 30" HIGH

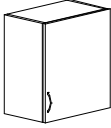
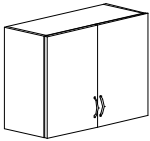
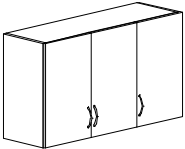
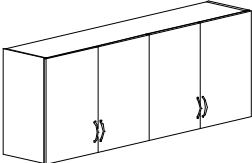
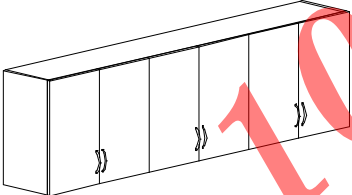
	MODEL NUMBER	SIZE D x W x H	WT.	ADJ. SHELVES	GROUP A	GROUP B
ONE DOOR						
	319-□-2430-□	15 x 24 x 30	82	1	684	753
	Extra Shelf, 15"d x 24"w, add \$75 List Price.					
TWO DOORS						
	319-3030-□ 319-3630-□	15 x 30 x 30 15 x 36 x 30	98 113	1 1	811 937	886 1024
	Extra Shelf, 15"d x 30"w, add \$92 List Price. Extra Shelf, 15"d x 36"w, add \$110 List Price.					
THREE DOORS						
	319-□-4230-□ 319-□-4830-□	15 x 42 x 30 15 x 48 x 30	139 154	2 2	1156 1282	1271 1409
	Extra Shelf, 15"d x 28"w, add \$92 List Price. Extra Shelf, 15"d x 32"w, add \$110 List Price.					
FOUR DOORS						
	319-6030-□ 319-7230-□	15 x 60 x 30 15 x 72 x 30	185 216	2 2	1524 1771	1673 1949
	Extra Shelf, 15"d x 30"w, add \$92 List Price. Extra Shelf, 15"d x 36"w, add \$110 List Price.					
SIX DOORS						
	319-8430-□ 319-9630-□	15 x 84 x 30 15 x 96 x 30	257 288	3 3	2122 2369	2340 2605
	Extra Shelf, 15"d x 28"w, add \$92 List Price. Extra Shelf, 15"d x 32"w, add \$110 List Price.					

OPTIONS:

- Single door lock add \$50 list.
- Lock for pair of doors, add \$70 list.
- Arc pulls in polished chrome or satin chrome, no upcharge.
- Master key, \$30.
- Key-change tool, \$30.
- Scribes 1-1/2"w add \$45 per side.
- Flush bottom (no fascia), no upcharge.
- Task light not included; see accessories page 119.

NOTES:

- Single door units, specify hinge at left or right:
add "L" or "R" after "319" in model number.
- Three door units, specify single door at left or right:
add "L" or "R" after "319" in model number.
- Please specify edge detail at the end of the model number.
- Standard with Arc Pulls in black.
- Standard with recessed back and wall cleat.
- Standard with task light fascia.



phone: (510) 259-6217
 email: info@actionlaminates.com

EDGE DETAILS

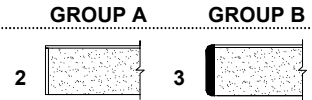

BASIC ELEMENTS

WALL MOUNT UPPER CABINET, 15" DEEP X 36" HIGH

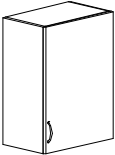
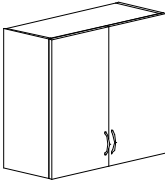
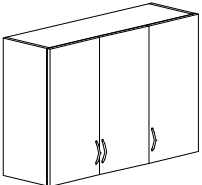
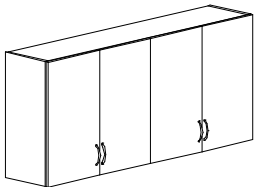
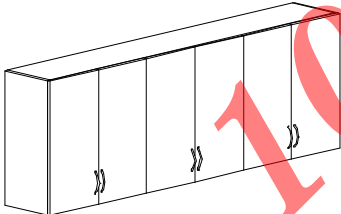
	MODEL NUMBER	SIZE	WT.	ADJ. SHELVES	GROUP A	GROUP B
D x W x H						
ONE DOOR						
	319-□-2436-□	15 x 24 x 36	100	2	857	943
	Extra Shelf, 15"d x 24"w, add \$75 List Price.					
TWO DOORS						
	319-3036-□	15 x 30 x 36	119	2	1006	1116
	319-3636-□	15 x 36 x 36	138	2	1167	1288
	Extra Shelf, 15"d x 30"w, add \$92 List Price.					
	Extra Shelf, 15"d x 36"w, add \$110 List Price.					
THREE DOORS						
	319-□-4236-□	15 x 42 x 36	169	4	1432	1581
	319-□-4836-□	15 x 48 x 36	188	4	1593	1748
	Extra Shelf, 15"d x 28"w, add \$92 List Price.					
	Extra Shelf, 15"d x 32"w, add \$110 List Price.					
FOUR DOORS						
	319-6036-□	15 x 60 x 36	226	4	1909	2093
	319-7236-□	15 x 72 x 36	264	4	2214	2438
	Extra Shelf, 15"d x 30"w, add \$92 List Price.					
	Extra Shelf, 15"d x 36"w, add \$110 List Price.					
SIX DOORS						
	319-8436-□	15 x 84 x 36	314	6	2645	2915
	319-9636-□	15 x 96 x 36	352	6	2961	3255
	Extra Shelf, 15"d x 28"w, add \$92 List Price.					
	Extra Shelf, 15"d x 32"w, add \$110 List Price.					

OPTIONS:

- Single door lock add \$50 list.
- Lock for pair of doors, add \$70 list.
- Arc pulls in polished chrome or satin chrome, no upcharge.
- Master key, \$30.
- Key-change tool, \$30.
- Scribes 1-1/2"w add \$45 per side.
- Flush bottom (no fascia), no upcharge.
- Task light not included; see accessories page 119.

NOTES:

- Single door units, specify hinge at left or right:
add "L" or "R" after "319" in model number.
- Three door units, specify single door at left or right:
add "L" or "R" after "319" in model number.
- Please specify edge detail at the end of the model number.
- Standard with Arc Pulls in black.
- Standard with recessed back and wall cleat.
- Standard with task light fascia.



phone: (510) 259-6217
email: info@actionlaminates.com

EDGE DETAILS

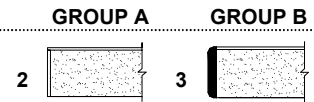

BASIC ELEMENTS

BASE CABINET, 18" DEEP X 34-3/4" HIGH

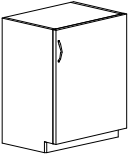
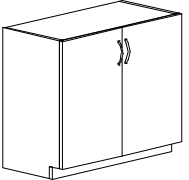
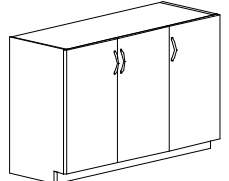
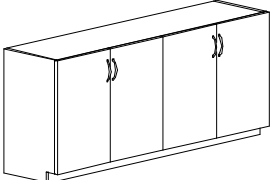
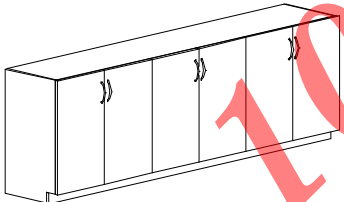
	MODEL NUMBER	SIZE	WT.	ADJ. SHELVES	GROUP A	GROUP B
	D x W x H					
ONE DOOR						
	320-□-2436-□	18 x 24 x 34-3/4	90	1	765	845
	Extra Shelf, 18"d x 24"w, add \$81 List Price					
TWO DOORS						
	320-3036-□	18 x 30 x 34-3/4	106	1	886	978
	320-3636-□	18 x 36 x 34-3/4	122	1	1018	1127
	Extra Shelf, 18"d x 30"w, add \$104 List Price					
	Extra Shelf, 18"d x 36"w, add \$127 List Price					
THREE DOORS						
	320-□-4236-□	18 x 42 x 34-3/4	151	2	1271	1403
	320-□-4836-□	18 x 48 x 34-3/4	167	2	1397	1530
	Extra Shelf, 18"d x 28"w, add \$104 List Price					
	Extra Shelf, 18"d x 32"w, add \$127 List Price					
FOUR DOORS						
	320-6036-□	18 x 60 x 34-3/4	198	2	1650	1817
	320-7236-□	18 x 72 x 34-3/4	230	2	1915	2099
	Extra Shelf, 18"d x 30"w, add \$104 List Price					
	Extra Shelf, 18"d x 36"w, add \$127 List Price					
SIX DOORS						
	320-8436-□	18 x 84 x 34-3/4	275	3	2289	2519
	320-9636-□	18 x 96 x 34-3/4	306	3	2542	2800
	Extra Shelf, 18"d x 28"w, add \$104 List Price					
	Extra Shelf, 18"d x 32"w, add \$127 List Price					

OPTIONS:

- Countertop not included. See Worksurfaces on page # 6.
- Single door lock add \$50 list.
- Lock for pair of doors, add \$70 list.
- Arc pulls in polished chrome or satin chrome, no upcharge.
- Master key, \$30.
- Key-change tool, \$30.
- Scribes 1-1/2"w add \$60 per side.

NOTES:

- Single door units, specify hinge at left or right:
add "L" or "R" after "320" in model number.
- Three door units, specify single door at left or right:
add "L" or "R" after "320" in model number.
- Please specify edge detail at the end of the model number.
- Standard with Arc Pulls in black.
- Standard with 3"d x 3"h toe kick.
- Standard with non-finished top and back.



phone: (510) 259-6217
email: info@actionlaminates.com

EDGE DETAILS

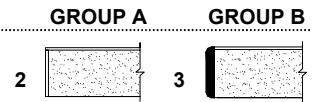

BASIC ELEMENTS

BASE CABINET, 18" DEEP X 40-3/4" HIGH

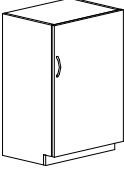
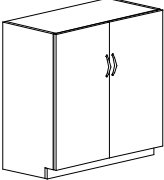
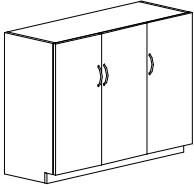
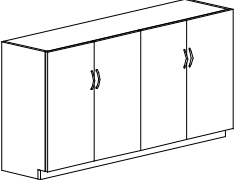
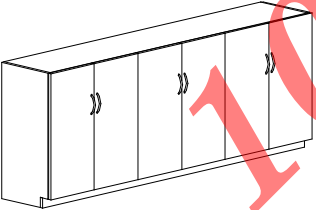
	MODEL NUMBER	SIZE	WT.	ADJ. SHELVES	GROUP A	GROUP B
	D x W x H					
ONE DOOR						
	320-□-2442-□	18 x 24 x 40-3/4	110	2	937	1024
	Extra Shelf, 18"d x 24"w, add \$81 List Price					
TWO DOORS						
	320-3042-□	18 x 30 x 40-3/4	129	2	1093	1208
	320-3642-□	18 x 36 x 40-3/4	149	2	1254	1380
	Extra Shelf, 18"d x 30"w, add \$104 List Price					
	Extra Shelf, 18"d x 36"w, add \$127 List Price					
THREE DOORS						
	320-□-4242-□	18 x 42 x 40-3/4	184	4	1564	1719
	320-□-4842-□	18 x 48 x 40-3/4	203	4	1725	1898
	Extra Shelf, 18"d x 28"w, add \$104 List Price					
	Extra Shelf, 18"d x 32"w, add \$127 List Price					
FOUR DOORS						
	320-6042-□	18 x 60 x 40-3/4	242	4	2041	2248
	320-7242-□	18 x 72 x 40-3/4	281	4	2363	2599
	Extra Shelf, 18"d x 30"w, add \$104 List Price					
	Extra Shelf, 18"d x 36"w, add \$127 List Price					
SIX DOORS						
	320-8442-□	18 x 84 x 40-3/4	336	6	2829	3111
	320-9642-□	18 x 96 x 40-3/4	375	6	3151	3462
	Extra Shelf, 18"d x 28"w, add \$104 List Price					
	Extra Shelf, 18"d x 32"w, add \$127 List Price					

OPTIONS:

- Countertop not included. See Worksurfaces on page # 6.
- Single door lock add \$50 list.
- Lock for pair of doors, add \$70 list.
- Arc pulls in polished chrome or satin chrome, no upcharge.
- Master key, \$30.
- Key-change tool, \$30.
- Scribes 1-1/2"w add \$60 per side.

NOTES:

- Single door units, specify hinge at left or right:
add "L" or "R" after "320" in model number.
- Three door units, specify single door at left or right:
add "L" or "R" after "320" in model number.
- Please specify edge detail at the end of the model number.
- Standard with Arc Pulls in black.
- Standard with 3"d x 3"h toe kick.
- Standard with non-finished top and back.



phone: (510) 259-6217
email: info@actionlaminates.com

EDGE DETAILS

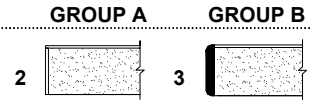

BASIC ELEMENTS
BASE CABINET, 23" DEEP X 34-3/4" HIGH

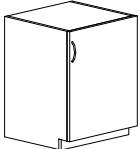
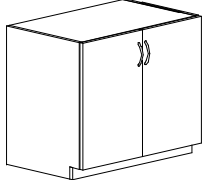
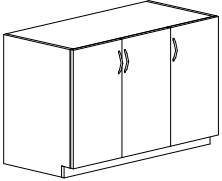
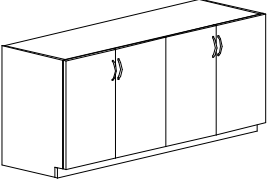
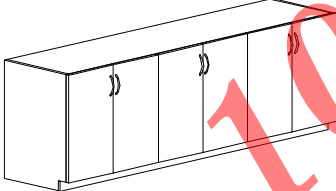
	MODEL NUMBER	SIZE	WT.	ADJ. SHELVES	GROUP A	GROUP B
	D x W x H					
ONE DOOR						
	321-□-2436-□	23 x 24 x 34-3/4	108	1	914	1006
	Extra Shelf, 23"d x 24"w, add \$104 List Price.					
TWO DOORS						
	321-3036-□	23 x 30 x 34-3/4	126	1	1064	1167
	321-3636-□	23 x 36 x 34-3/4	144	1	1213	1334
	Extra Shelf, 23"d x 30"w, add \$138 List Price.					
	Extra Shelf, 23"d x 36"w, add \$161 List Price.					
THREE DOORS						
	321-□-4236-□	23 x 42 x 34-3/4	180	2	1524	1673
	321-□-4836-□	23 x 48 x 34-3/4	198	2	1668	1840
	Extra Shelf, 23"d x 28"w, add \$138 List Price.					
	Extra Shelf, 23"d x 32"w, add \$161 List Price.					
FOUR DOORS						
	321-6036-□	23 x 60 x 34-3/4	234	2	1961	2162
	321-7236-□	23 x 72 x 34-3/4	270	2	2260	2484
	Extra Shelf, 23"d x 30"w, add \$138 List Price.					
	Extra Shelf, 23"d x 36"w, add \$161 List Price.					
SIX DOORS						
	321-8436-□	23 x 84 x 34-3/4	324	3	2720	2996
	321-9636-□	23 x 96 x 34-3/4	360	3	3013	3318
	Extra Shelf, 23"d x 28"w, add \$138 List Price.					
	Extra Shelf, 23"d x 32"w, add \$161 List Price.					

OPTIONS:

- Countertop not included. See Worksurfaces on page # 6.
- Single door lock add \$50 list.
- Lock for pair of doors, add \$70 list.
- Arc pulls in polished chrome or satin chrome, no upcharge.
- Master key, \$30.
- Key-change tool, \$30.
- Scribes 1-1/2"w add \$60 per side.

NOTES:

- Single door units, specify hinge at left or right:
add "L" or "R" after "321" in model number.
- Three door units, specify single door at left or right:
add "L" or "R" after "321" in model number.
- Please specify edge detail at the end of the model number.
- Standard with Arc Pulls in black.
- Standard with 3"d x 3"h toe kick.
- Standard with non-finished top and back.



phone: (510) 259-6217
email: info@actionlaminates.com

EDGE DETAILS

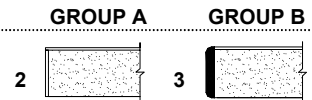

BASIC ELEMENTS

BASE CABINET, 23" DEEP X 40-3/4" HIGH

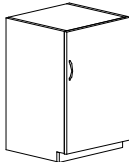
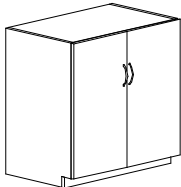
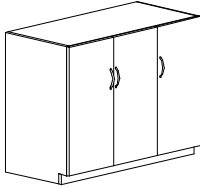
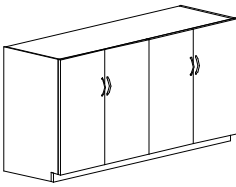
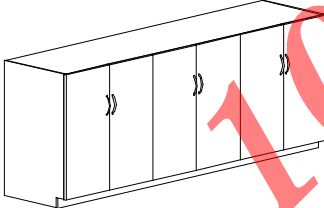
	MODEL NUMBER	SIZE	WT.	ADJ. SHELVES	GROUP A	GROUP B
D x W x H						
ONE DOOR						
	321-□-2442-□	23 x 24 x 40-3/4	132	2	1133	1242
	Extra Shelf, 23"d x 24"w, add \$104 List Price.					
TWO DOORS						
	321-3042-□	23 x 30 x 40-3/4	155	2	1317	1455
	321-3642-□	23 x 36 x 40-3/4	177	2	1507	1656
	Extra Shelf, 23"d x 30"w, add \$138 List Price.					
	Extra Shelf, 23"d x 36"w, add \$161 List Price.					
THREE DOORS						
	321-□-4242-□	23 x 42 x 40-3/4	221	4	1880	2076
	321-□-4842-□	23 x 48 x 40-3/4	243	4	2076	2283
	Extra Shelf, 23"d x 28"w, add \$138 List Price.					
	Extra Shelf, 23"d x 32"w, add \$161 List Price.					
FOUR DOORS						
	321-6042-□	23 x 60 x 40-3/4	288	4	2450	2697
	321-7242-□	23 x 72 x 40-3/4	333	4	2818	3099
	Extra Shelf, 23"d x 30"w, add \$138 List Price.					
	Extra Shelf, 23"d x 36"w, add \$161 List Price.					
SIX DOORS						
	321-8442-□	23 x 84 x 40-3/4	399	6	3387	3720
	321-9642-□	23 x 96 x 40-3/4	444	6	3761	4134
	Extra Shelf, 23"d x 28"w, add \$138 List Price.					
	Extra Shelf, 23"d x 32"w, add \$161 List Price.					

OPTIONS:

- Countertop not included. See Worksurfaces on page # 6.
- Single door lock add \$50 list.
- Lock for pair of doors, add \$70 list.
- Arc pulls in polished chrome or satin chrome, no upcharge.
- Master key, \$30.
- Key-change tool, \$30.
- Scribes 1-1/2"w add \$60 per side.

NOTES:

- Single door units, specify hinge at left or right:
add "L" or "R" after "321" in model number.
- Three door units, specify single door at left or right:
add "L" or "R" after "321" in model number.
- Please specify edge detail at the end of the model number.
- Standard with Arc Pulls in black.
- Standard with 3"d x 3"h toe kick.
- Standard with non-finished top and back.



phone: (510) 259-6217
email: info@actionlaminates.com

EDGE DETAILS

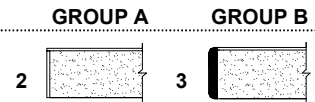

BASIC ELEMENTS WALL MOUNT MAIL ORGANIZER

ADJ.							
MODEL NUMBER	SIZE	WT.	COLUMNS	SHELVES	GROUP A	GROUP B	
D x W x H							
333-3018-□	14 x 30 x 18	98	3	18	794	874	
333-4218-□	14 x 42 x 18	134	4	24	1225	1346	
333-4818-□	14 x 48 x 18	154	5	30	1415	1558	
333-5418-□	14 x 54 x 18	169	5	30	1553	1708	
333-6018-□	14 x 60 x 18	190	6	36	1742	1921	
333-7218-□	14 x 72 x 18	226	7	42	2076	2283	
<hr/>							
333-3024-□	14 x 30 x 24	124	3	24	1144	1259	
333-4224-□	14 x 42 x 24	169	4	32	1553	1708	
333-4824-□	14 x 48 x 24	195	5	40	1794	1972	
333-5424-□	14 x 54 x 24	214	5	40	1961	2162	
333-6024-□	14 x 60 x 24	240	6	48	2214	2432	
333-7224-□	14 x 72 x 24	285	7	56	2622	2887	
<hr/>							
333-3030-□	14 x 30 x 30	150	3	30	1386	1518	
333-4230-□	14 x 42 x 30	204	4	40	1875	2070	
333-4830-□	14 x 48 x 30	236	5	50	2174	2386	
333-5430-□	14 x 54 x 30	258	5	50	2381	2622	
333-6030-□	14 x 60 x 30	290	6	60	2674	2944	
333-7230-□	14 x 72 x 30	344	7	70	3168	3490	
<hr/>							
333-3036-□	14 x 30 x 36	176	3	36	1622	1783	
333-4236-□	14 x 42 x 36	239	4	48	2202	2427	
333-4836-□	14 x 48 x 36	277	5	60	2547	2806	
333-5436-□	14 x 54 x 36	303	5	60	2795	3071	
333-6036-□	14 x 60 x 36	340	6	72	3140	3450	
333-7236-□	14 x 72 x 36	403	7	84	3720	4100	
<hr/>							
333-3048-□	14 x 30 x 48	228	3	48	2105	2306	
333-4248-□	14 x 42 x 48	310	4	64	2852	3145	
333-4848-□	14 x 48 x 48	359	5	80	3312	3640	
333-5448-□	14 x 54 x 48	391	5	80	3611	3973	
333-6048-□	14 x 60 x 48	440	6	96	4060	4468	
333-7248-□	14 x 72 x 48	522	7	112	4824	5302	

OPTIONS:

Extra laminate shelf, \$25 List.
1/4" thick clear acrylic shelves, in place of laminate shelf, same price.

NOTES:

Please specify edge detail at the end of the model number.
7/8" thick construction; shelves are 1/2" thick.
Shelves adjust with metal pins on 1-1/4" centers.
Standard with recessed back and wall cleat.
Standard with flush bottom.



phone: (510) 259-6217
email: info@actionlaminates.com

EDGE DETAILS

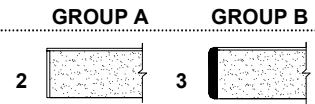

BASIC ELEMENTS MAIL ORGANIZER HUTCH UNITS

ADJ.							
MODEL NUMBER	SIZE	WT.	COLUMNS	SHELVES	GROUP A	GROUP B	
D x W x H							
334-3030-□	14 x 30 x 30	114	3	18	1041	1144	
334-4230-□	14 x 42 x 30	152	4	24	1392	1524	
334-4830-□	14 x 48 x 30	174	5	30	1593	1748	
334-5430-□	14 x 54 x 30	191	5	30	1742	1921	
334-6030-□	14 x 60 x 30	213	6	36	1944	2139	
334-7230-□	14 x 72 x 30	252	7	42	2300	2530	
<hr/>							
334-3036-□	14 x 30 x 36	140	3	24	1282	1409	
334-4236-□	14 x 42 x 36	187	4	32	1719	1880	
334-4836-□	14 x 48 x 36	216	5	40	1972	2174	
334-5436-□	14 x 54 x 36	236	5	40	2162	2375	
334-6036-□	14 x 60 x 36	264	6	48	2421	2657	
334-7236-□	14 x 72 x 36	312	7	56	2864	3151	
<hr/>							
334-3042-□	14 x 30 x 42	166	3	30	1518	1668	
334-4242-□	14 x 42 x 42	223	4	40	2041	2248	
334-4842-□	14 x 48 x 42	256	5	50	2352	2582	
334-5442-□	14 x 54 x 42	280	5	50	2565	2818	
334-6042-□	14 x 60 x 42	314	6	60	2881	3163	
334-7242-□	14 x 72 x 42	370	7	70	3410	3743	
<hr/>							
334-3048-□	14 x 30 x 48	192	3	36	1754	1932	
334-4248-□	14 x 42 x 48	258	4	48	2369	2605	
334-4848-□	14 x 48 x 48	297	5	60	2726	3002	
334-5448-□	14 x 54 x 48	324	5	60	2979	3278	
334-6048-□	14 x 60 x 48	363	6	72	3341	3674	
334-7248-□	14 x 72 x 48	429	7	84	3950	4353	

OPTIONS:

Extra laminate shelf, \$25 List.
1/4" thick clear acrylic shelves, in place of laminate shelf, same price.

NOTES:

Please specify edge detail at the end of the model number.
7/8" thick construction; shelves are 1/2" thick.
Shelves adjust with metal pins on 1-1/4" centers.
Standard with 12" height clearance below bottom shelf.
Standard with fully enclosed, finished back.
Standard with attachment hardware.



phone: (510) 259-6217
email: info@actionlaminates.com

BASIC ELEMENTS SPECIALITY CABINETS

EDGE DETAILS

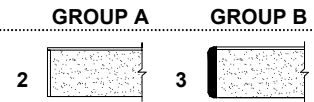

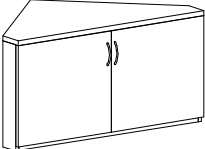
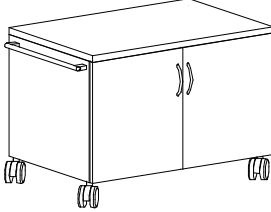
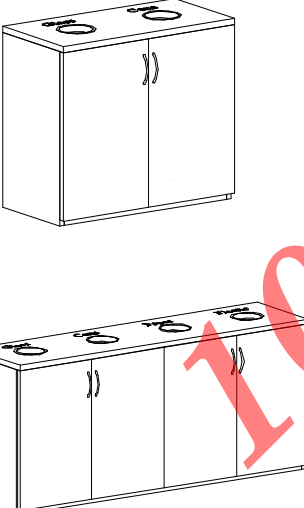
	MODEL NUMBER	SIZE	WT.	ADJ. SHELVES	GROUP A	GROUP B
CORNER CABINET						
		D x W x H				
	330-3029-□	30 x 30 x 29	140	1	1116	1225
	330-3629-□	36 x 36 x 29	185	1	1478	1622
MOBILE CABINET						
	331-183029-□	18 x 30 x 29	94	1	1104	1185
	331-243029-□	24 x 30 x 29	113	1	1300	1403
	331-183629-□	18 x 36 x 29	108	1	1231	1328
	331-243629-□	24 x 36 x 29	129	1	1443	1564
RECYCLE CABINET						
				OPENINGS		
	332-183629-□	18 x 36 x 29	106	2	1162	1259
	332-183636-□	18 x 36 x 36	122	2	1305	1420
	332-183642-□	18 x 36 x 42	137	2	1455	1581
	332-184829-□	18 x 48 x 29	141	3	1581	1708
	332-184836-□	18 x 48 x 36	162	3	1771	1926
	332-184842-□	18 x 48 x 42	183	3	1967	2139
	332-186029-□	18 x 60 x 29	176	4	1995	2162
	332-186036-□	18 x 60 x 36	203	4	2237	2427
	332-186042-□	18 x 60 x 42	229	4	2478	2697
	332-187229-□	18 x 72 x 29	200	4	2214	2398
332-187236-□	18 x 72 x 36	230	4	2490	2703	
332-187242-□	18 x 72 x 42	259	4	2760	3002	

OPTIONS:

Arc pulls in polished chrome or satin chrome, no upcharge.
Double door lock add \$70 list.
Master key, \$30.
Key-change tool, \$30.

NOTES:

Please specify edge detail at the end of the model number.
Standard with Arc Pulls in black.
Mobile cabinet includes black dual wheel casters with 4" diameter wheels and brake.
Mobile cabinet includes (1) stainless steel grip.
Recycle cabinet does not include adjustable shelves.
Recycle cabinet includes one 6" dia. plastic waste grommet and signage per opening.



phone: (510) 259-6217
email: info@actionlaminates.com

BASIC ELEMENTS ACCESSORIES

	MODEL NUMBER	SIZE	WT.	LIST PRICE	C.O.M. Yardage
WALL MOUNT FABRIC TACK BOARDS					
		H x W x THICKNESS			
	TB-WM-2436	24 x 36 x 1"	7	305	1.25
	TB-WM-2448	24 x 48 x 1"	10	334	1.50
	TB-WM-2460	24 x 60 x 1"	14	403	2.00
	TB-WM-2472	24 x 72 x 1"	18	472	2.25
	TB-WM-2484	24 x 84 x 1"	21	535	2.50
	TB-WM-2496	24 x 96 x 1"	24	569	3.00
HUTCH MOUNT FABRIC TACK BOARDS					
	TB-HM-1836	18 x 34.25 x .5"	7	282	1.25
	TB-HM-1848	18 x 46.25 x .5"	10	311	1.50
	TB-HM-1860	18 x 58.25 x .5"	14	374	2.00
	TB-HM-1872	18 x 70.25 x .5"	18	431	2.25
	TB-HM-1884	18 x 84.25 x .5"	21	483	2.50
	TB-HM-1896	18 x 94.25 x .5"	24	512	3.00
FLUORESCENT TASK LIGHTS*					
	TL-F-18-BK	18"w Fits 24" shelf	5	125	*Available while Supplies last. To be replaced by same unit with LED bulb.
	TL-F-24-BK	24"w Fits 30-36" shelf	7	135	
	TL-F-36-BK	36"w Fits 42-48" shelf	9	160	
	TL-F-48-BK	48"w Fits 60" shelf	11	180	
	TL-F-60-BK	60"w Fits 72" shelf	13	265	
LED TASK LIGHTS					
	TL-LED-7W-18	18"w Fits 24" shelf	6	196	
	TL-LED-13W-24	24"w Fits 30-36" shelf	7	224	
	TL-LED-17W-36	36"w Fits 42-48" shelf	10	299	
	TL-LED-20W-48	48"w Fits 60" shelf	13	368	
	TL-LED-21W-60	60"w Fits 72" shelf	16	454	





OPTIONS:

Cord channel for wall mount tack board available. Add \$15 list. Please specify position.
LED Task light case is solid aluminum alloy
LED Task lights can be daisy-chained together
Please specify LED light color from Kelvin scale
3000K Warm White = WW, or 5200K Cool White = CW.
Other LED Task light sizes available, please consult factory.

NOTES:

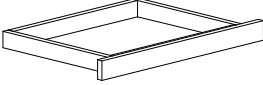
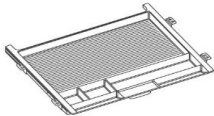
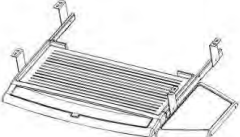
Standard fabric is Guilford of Maine "Crosstown", "Mingle", "Anchorage" & "FR701". Please specify the color.
Tack Boards are attached to hutch back panel with pin nails.
Wall mount tack boards include recessed back with wall cleat.
Fluorescent Task light case finish is black.
LED Task light is Daisy-chain compatible includes a 12" Daisy-chain cable.

BASIC ELEMENTS ACCESSORIES

	MODEL NUMBER	SIZE D x W x H	WT.	FINISH	LIST PRICE
PENCIL DRAWER, LAMINATE FRONT					
	PD-24	16 x 24 x 3	15	Standard matte finish, laminate front	185
PLASTIC PENCIL DRAWER					
	PPD-21	19 x 21 x 2	5	Black plastic	88
PLASTIC KEYBOARD TRAY					
	PKT-26	18-1/4 X 21/26-1/4 X 2	5	Black plastic	95
HORIZONTAL WIRE MANAGER					
	WM-2-□	1-1/4" x 2-1/2"		Black plastic	\$12 per lineal ft
VERTICAL WIRE MANAGER					
	VWM-1	2 X 22		Black plastic Silver plastic	33 33
ONE-PIECE VERTICAL WIRE MANAGER					
	WM-1-□	1-3/4" X 15/16"		Black plastic Silver plastic	\$12 per lineal ft
VERTEBRA WIRE MANAGER					
	VWM-4	2-3/16" X 32"		Black plastic Silver plastic	110 110

OPTIONS:

NOTES:



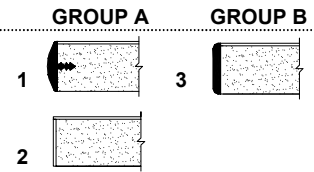

phone: (510) 259-6217
email: info@actionlaminates.com

EDGE DETAILS

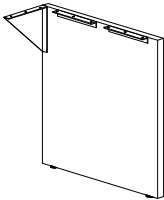
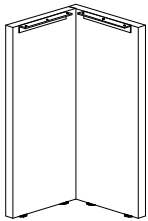

BASIC ELEMENTS
SUPPORT PANELS AND WALL BRACKETS

	MODEL NUMBER	SIZE	WT.	GROUP A	GROUP B
MID SUPPORTS					
		D x W x H			
	MS-12-□	12 x 27.75	9	149	173
	MS-15-□	15 x 27.75	11	155	179
END SUPPORT PANELS					
	ESP-12-□	12 x 27.75	14	149	173
	ESP-15-□	15 x 27.75	17	155	179
	ESP-20-□	20 x 27.75	14	196	220
	ESP-24-□	24 x 27.75	17	214	232
	ESP-30-□	30 x 27.75	21	244	262
	ESP-36-□	36 x 27.75	25	303	321
	ESP-48-□	48 x 27.75	30	393	417
L-SHAPED CORNER SUPPORT					
	CL-12-□	12 x 12 x 27.75	18	262	292
	CL-15-□	15 x 15 x 27.75	22	274	303
WALL BRACKET FOR WORKSURFACES					
	WMB-812-B	8 x 12	3	105	
	WMB-1518-B	15 x 18	6	126	
	WMB-2128-B	21 x 28	9	147	

NOTES:

Please specify edge detail at the end of the model number.
Support panels include adjustable glides and attaching hardware.
Wall brackets are finished with flat black powder coat.



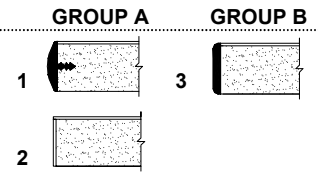

phone: (510) 259-6217
email: info@actionlaminates.com

EDGE DETAILS

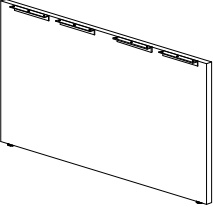

**BASIC ELEMENTS
MODESTY PANELS AND HARDWARE**

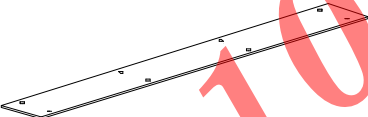
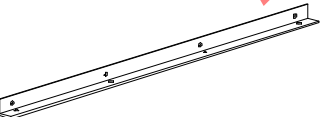
	MODEL NUMBER	SIZE	WT.		GROUP A	GROUP B	
LAMINATE MODESTY PANELS							
		W x H					
	MP-48-□	48 x 27.75	30		393	417	
	MP-60-□	60 x 27.75	45		494	518	
	MP-72-□	72 x 27.75	55		583	607	
	MP-96-□	96 x 27.75	70		756	779	
	MP-120-□	120 x 27.75	90		887	904	
	MP-144-□	144 x 27.75	105		1131	1148	
UNIVERSAL METAL MODESTY PANELS							
	UMM-S-36	35-3/4" x 9"	7	Solid Front	215		
	UMM-S-48	47-3/4" x 9"	8	Solid Front	237		
	UMM-S-60	59-3/4" x 9"	9	Solid Front	281		
	UMM-S-72	71-3/4" x 9"	10	Solid Front	292		
	UMM-P-36	35-3/4" x 9"	7	Perf. Front	220		
	UMM-P-48	47-3/4" x 9"	8	Perf. Front	242		
	UMM-P-60	59-3/4" x 9"	9	Perf. Front	215		
	UMM-P-72	71-3/4" x 9"	10	Perf. Front	330		
	UNIVERSAL FABRIC MODESTY PANELS						
		FMP-36	36" x 10"	2		213	
FMP-48		48" x 10"	2		219		
FMP-60		60" x 10"	3		247		
FMP-72		72" x 10"	4		288		
FLAT BRACKETS							
	FB-18	FOR 20-24"D TOPS			42		
	FB-24	FOR 30-36"D TOPS			44		
L-BRACKETS							
	LB-18	FOR 20-24"D TOPS			42		
	LB-24	FOR 30-36"D TOPS			44		

OPTIONS:

Other colors of metal modesty panels are available, please consult factory.

NOTES:

Please specify edge detail at the end of the model number. Laminated modesty panels include adjustable glides and attaching hardware. Hardware is finished with flat black powder coat. Metal modesty panels are matte black standard. Fabric modesty panels are black only.



phone: (510) 259-6217
email: info@actionlaminates.com

BASIC ELEMENTS ACCESSORIES - DOOR / DRAWER PULLS

	MODEL NUMBER	SIZE	WT.	FINISH	LIST PRICE	
	PULL-1	5" C-to-C		Black, Polished Chrome, Satin Chrome, Nickel Matte	8	All
	PULL-2	5" C-to-C		Brushed Stainless Steel Black Matte	8 8	S.S. B
	PULL-3	5" C-to-C		Matte Chrome, Matte Nickel	18	All
	PULL-4	5" C-to-C		Brushed Nickel	13	B. N.
	PULL-5	4" C-to-C		Silver Anodized, Bronze, Matt Silver, Satin Chrome, Polished Black, Polished Chrome,	38	All
	PULL-6	2" C-to-C		Black, Polished Chrome, Satin Chrome	23	All
	PULL-7	5" C-to-C		Matt Stainless Steel	30	Matt S.S
	PULL-8	5" C-to-C		Stainless Steel	13	All
	PULL-9	2-1/2" C-to-C		Black, Polished Chrome, Stainless Steel	24 35 35	Black Chrome S.S.
	PULL -10	5" C-to-C		Polished Chrome Stainless Steel	14 12	Chrome S.S.

OPTIONS:

Many other pull styles are available, please consult factory.

NOTES:



phone: (510) 259-6217
 email: info@actionlaminates.com

BASIC ELEMENTS ACCESSORIES - GROMMETS

	MODEL NUMBER	SIZE	WT.	FINISH	LIST PRICE
	GR-1-BK	3/4" hole		Black	26
	GR-3-BK	2-1/2" hole		Black	30
	GR-4-BK	4" hole		Black	45
	GR-3-SC	2-1/2" hole		Satin Chrome	65
	GR-3-PC	2-1/2" hole		Polished Chrome	65
	GR-3-PB	2-1/2" hole		Polished Brass	75
				(Plastic plated grommets)	
	GR-5-SC	2-1/2" hole		Satin Chrome	145
	GR-5-PC	2-1/2" hole		Polished Chrome	145
	GR-5-PB	2-1/2" hole		Polished Brass	155
				(Solid brass plated grommets)	

Add 10% effective 7/1/2024

OPTIONS:

Grommets available in other sizes. Consult factory.
 Plastic grommets available in other colors. Consult factory.
 Metal grommets available in other finishes. Consult factory.

NOTES:



phone: (510) 259-6217
 email: info@actionlaminates.com

Landmark Series Table of Contents

Edge Details and Finish Specifications	127
Accessories	
Fabric Tack Boards - Hutch Mount	171
Pencil Drawers, Keyboard Drawers	172
Task Lights	171
Wire Management	172
Drawer and Door Pulls	173
Hutch Units	
Bookcase/hutch	160
Open Without Top	157
Open With Top	158
With Hinged Doors	159
Lateral Files	
Freestanding Lateral files	156
Storage Components	
Open Bookcases	161-162
Storage Cabinets	167-168
Wardrobe Cabinets	166
Inset Doors, Laminate, Glass, Framed Glass	163-165
Workstation Components	
Bridge Units	152
Bullet Units	145
Convex Units	145
Corner units	133-135
Credenza - Shell	131
Credenza - Single Pedestal	131
Credenza - Double Pedestal	131
Credenza - Executive	132
Credenza - Lateral File	132
Credenza - Storage	132



phone: (510) 259-6217
email: info@actionlaminates.com

Landmark Series Table of Contents

Workstation Components, continued

Desk - Shell	128
Desk - Single Pedestal	129
Desk - Double Pedestal	130
Extended Corner Bullet Units	146-148
Extended Corner P Shape Units	149-151
Extended Corner Units - Open	136-138
Extended Corner Units - Single Pedestal	139-141
Extended Corner Units - Lateral File	142-144
Returns - Open	153
Returns - Single Pedestal	154
Returns - Lateral File	155
Study Carrels	169-170



100% effective
7/1/2024



phone: (510) 259-6217
email: info@actionlaminates.com

LANDMARK SERIES

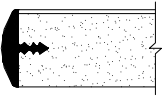
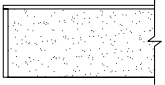
EDGE DETAILS AND FINISH SPECIFICATIONS

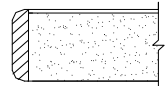
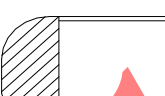
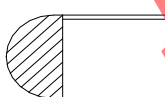
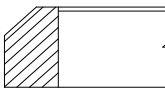
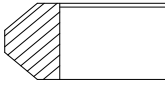
	DESCRIPTION	STANDARD COLORS
GROUP A		
EDGE 1	<p>T-Mold</p>  <p>Core Material: 45lb high density particle board finished with high pressure laminate top, backing sheet on the bottom.</p> <p>Edge: T-Molding 3/16" x 1 1/4" thick.</p>	Almond, Beige, Black, Brown, Charcoal, Clay, Dark Tone, Graphite, Greystone, Innertone Light, Innertone R, Light Grey, Light Tone, Medium Tone, Platinum, Putty, R-Beige, Sand, Smoke, Soft White, Taupe - Lt Tone, White.
EDGE 2	<p>Self Edge</p>  <p>Core Material: 45lb high density particle board finished with high pressure laminate top, backing sheet on the bottom.</p> <p>Edge: High pressure laminate 1/16" x 1 1/4" thick.</p>	High pressure laminate matching the top. Contrasting self edge consult factory for pricing.
GROUP B		
EDGE 3	<p>PVC Edge</p>  <p>Core Material: 45lb high density particle board finished with high pressure laminate top, backing sheet on the bottom.</p> <p>Edge: PVC 3 mm x 1 1/4" thick.</p>	Antique White, Beigewood, Black, Boardwalk Oak, Cocobala, Designer White, Dove Grey, Fawn Cypress, Figured Mahogany, Fonhill Pear, Frosty White, Fusion Maple, Golden Oak, Grey 1500, Hardrock Maple, Henna Cherry, HM Innertone Light, HM Innertone-R, HM Mediumtone, HW Graphite, HW Putty, HW Smoke, Kensington Maple, Manitoba Maple, Monticello Maple, Pebble, Pepperdust, Platinum, Regency Walnut, River Cherry, Skyline Walnut, Slate, Sterling Ash, Studio Teak, Walnut Heights, Wild Cherry, Windsor Mahogany, Yorkshire Cherry, Witchcraft 1.5mm Satin Chrome
GROUP D		
EDGE 13	<p>1/8" Eased Wood Edge</p>  <p>Core Material: 45lb high density particle board finished with high pressure laminate top, backing sheet on the bottom.</p> <p>Edge: Wood edge, 1/8" x 1 1/4" thick.</p>	Species: Maple, Cherry, Oak or Walnut.
GROUP E		
EDGE 14	<p>Radius Wood Edge</p>  <p>Core Material: 45lb high density particle board finished with high pressure laminate top, backing sheet on the bottom.</p> <p>Edge: Wood edge, 3/4" x 1 1/4" thick.</p>	Species: Maple, Cherry, Oak or Walnut.
EDGE 15	<p>Bullnose Wood</p>  <p>Core Material: 45lb high density particle board finished with high pressure laminate top, backing sheet on the bottom.</p> <p>Edge: Wood edge, 3/4" x 1 1/4" thick.</p>	Species: Maple, Cherry, Oak or Walnut.
EDGE 16	<p>Bevel Wood Edge</p>  <p>Core Material: 45lb high density particle board finished with high pressure laminate top, backing sheet on the bottom.</p> <p>Edge: Wood edge, 3/4" x 1 1/4" thick.</p>	Species: Maple, Cherry, Oak or Walnut.
EDGE 17	<p>Double Beveled Wood Edge</p>  <p>Core Material: 45lb high density particle board finished with high pressure laminate top, backing sheet on the bottom.</p> <p>Edge: Wood edge, 3/4" x 1 1/4" thick.</p>	Species: Maple, Cherry, Oak or Walnut.

Laminates: Standard matte finishes in solid, wood grain, and patterns from Wilsonart, Formica, Nevamar, and Pionite.

Premium finishes or laminates by Abet laminati, Laminart, and others are available upon request.



phone: (510) 259-6217
email: info@actionlaminates.com

EDGE DETAILS

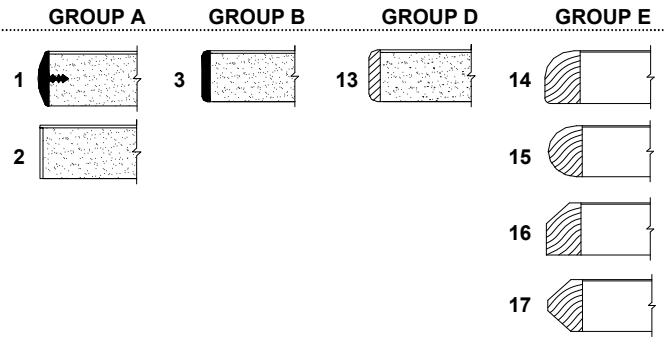

LANDMARK SERIES DESKS

	MODEL NUMBER	SIZE	WT.	GROUP A	GROUP B	GROUP D	GROUP E	
DESK SHELL								
	400-3060- □	30 x 60	165	966	1052	1386	1570	
	400-3066- □	30 x 66	176	1087	1173	1570	1771	
	400-3072- □	30 x 72	187	1087	1173	1570	1771	
	400-3096- □	30 x 96	231	1328	1432	1921	2179	
	400-3660- □	36 x 60	187	1087	1190	1530	1737	
	400-3666- □	36 x 66	199	1219	1323	1725	1944	
	400-3672- □	36 x 72	212	1219	1323	1725	1944	
	400-3696- □	36 x 96	260	1489	1610	2093	2369	
	Note: modesty panel is recessed 6".							
	DESK SHELL- BOW FRONT							
	401-3060- □	24/30 x 60	165	1064	1150	1484	1673	
	401-3066- □	24/30 x 66	176	1190	1271	1662	1869	
	401-3072- □	24/30 x 72	187	1190	1271	1662	1869	
	401-3096- □	24/30 x 96	231	1426	1535	2018	2277	
	401-3660- □	30/36 x 60	187	1190	1288	1633	1834	
	401-3666- □	30/36 x 66	199	1317	1420	1823	2041	
	401-3672- □	30/36 x 72	212	1317	1420	1823	2041	
	401-3696- □	30/36 x 96	260	1587	1708	2191	2461	
	Note: modesty panel is positioned flush to rear of end panels.							

OPTIONS:

Round Grommet 3" add \$ 30 List.

NOTES:

- Desk shells with t-mold edge have t-mold edge on end panels.
- Desk shells with 3mm pvc edgebanding have 3mm pvc edgebanding on end panels.
- Desk shells with all other edge details have self edge on end panels.



phone: (510) 259-6217
email: info@actionlaminates.com

EDGE DETAILS

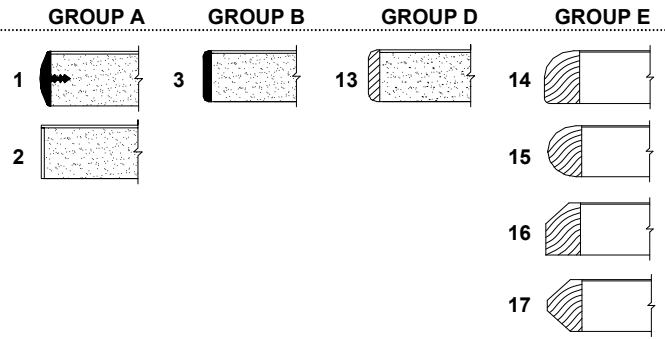

LANDMARK SERIES DESKS WITH SINGLE PEDESTAL

	MODEL NUMBER	SIZE	WT.	GROUP A	GROUP B	GROUP D	GROUP E	
SINGLE PEDESTAL DESK								
	402-□-3060-□	30 x 60	260	1656	1742	2076	2266	
	402-□-3066-□	30 x 66	271	1777	1863	2260	2467	
	402-□-3072-□	30 x 72	282	1777	1863	2260	2467	
	402-□-3096-□	30 x 96	326	2024	2128	2611	2869	
	402-□-3660-□	36 x 60	282	1777	1875	2225	2427	
	402-□-3666-□	36 x 66	294	1909	2018	2409	2634	
	402-□-3672-□	36 x 72	307	1909	2018	2409	2634	
	402-□-3696-□	36 x 96	355	2179	2300	2795	3059	
	Note: modesty panel is recessed 6".							
	SINGLE PEDESTAL DESK- BOW FRONT							
	403-□-3060-□	24/30 x 60	260	1754	1840	2174	2363	
	403-□-3066-□	24/30 x 66	271	1875	1961	2358	2565	
	403-□-3072-□	24/30 x 72	282	1875	1961	2358	2565	
	403-□-3096-□	24/30 x 96	326	2122	2225	2708	2967	
	403-□-3660-□	30/36 x 60	282	1875	1972	2323	2524	
	403-□-3666-□	30/36 x 66	294	2013	2116	2513	2731	
	403-□-3672-□	30/36 x 72	307	2013	2116	2513	2731	
	403-□-3696-□	30/36 x 96	355	2277	2398	2892	3157	
	Note: modesty panel is positioned flush to rear of end panels.							

OPTIONS:

Round Grommet 3" add \$ 30 List.

NOTES:

Desks with t-mold edge have t-mold edge on end panels.
 Desks with 3mm pvc edgebanding have 3mm pvc edgebanding on end panels.
 Desks with all other edge details have self edge on end panels.
 Please specify pedestal at left or right:
 add "L" or "R" after "402" or "403" in model number



phone: (510) 259-6217
email: info@actionlaminates.com

EDGE DETAILS

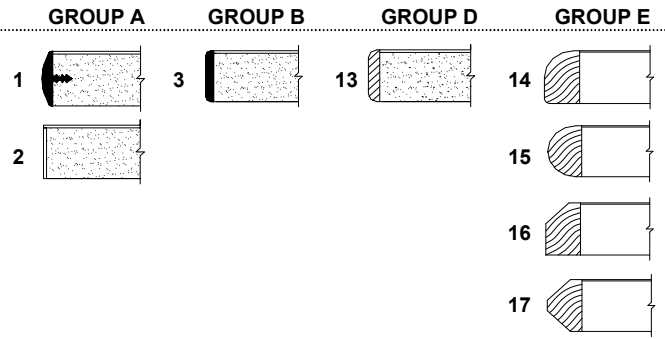

LANDMARK SERIES DESKS WITH DOUBLE PEDESTALS

	MODEL NUMBER	SIZE	WT.	GROUP A	GROUP B	GROUP D	GROUP E
DOUBLE PEDESTAL DESK							
	404-3060- ☐	30 x 60	355	2352	2438	2772	2956
	404-3066- ☐	30 x 66	366	2473	2559	2950	3157
	404-3072- ☐	30 x 72	377	2473	2559	2950	3157
	404-3096- ☐	30 x 96	421	2714	2818	3301	3565
	404-3660- ☐	36 x 60	377	2473	2570	2915	3117
	404-3666- ☐	36 x 66	389	2605	2708	3105	3329
	404-3672- ☐	36 x 72	402	2605	2708	3105	3329
	404-3696- ☐	36 x 96	450	2875	2996	3485	3755
	Note: modesty panel is recessed 6".						

	MODEL NUMBER	SIZE	WT.	GROUP A	GROUP B	GROUP D	GROUP E
DOUBLE PEDESTAL DESK- BOW FRONT							
	405-3060- ☐	24/30 x 60	355	2450	2530	2864	3053
	405-3066- ☐	24/30 x 66	366	2570	2657	3048	3255
	405-3072- ☐	24/30 x 72	377	2570	2657	3048	3255
	405-3096- ☐	24/30 x 96	421	2812	2915	3398	3663
	405-3660- ☐	30/36 x 60	377	2570	2668	3013	3220
	405-3666- ☐	30/36 x 66	389	2703	2806	3197	3427
	405-3672- ☐	30/36 x 72	402	2703	2806	3197	3427
	405-3696- ☐	30/36 x 96	450	2967	3094	3582	3847
	Note: modesty panel is positioned flush to rear of end panels.						

OPTIONS:

Round Grommet 3" add \$ 30 List.

NOTES:

Desks with t-mold edge have t-mold edge on end panels.
Desks with 3mm pvc edgebanding have 3mm pvc edgebanding on end panels.
Desks with all other edge details have self edge on end panels.



phone: (510) 259-6217
email: info@actionlaminates.com

EDGE DETAILS

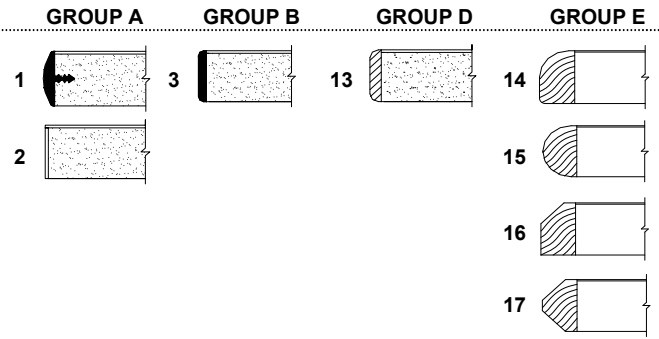

LANDMARK SERIES CREDENZAS

	MODEL NUMBER	SIZE	WT.	GROUP A	GROUP B	GROUP D	GROUP E	
CREDENZA SHELL								
	410-2048- □	20 x 48	110	656	713	978	1116	
	410-2060- □	20 x 60	128	765	817	1139	1300	
	410-2072- □	20 x 72	147	868	932	1300	1489	
	410-2096- □	20 x 96	183	1081	1150	1616	1857	
	410-2448- □	24 x 48	123	736	788	1070	1219	
	410-2460- □	24 x 60	143	851	909	1231	1409	
	410-2472- □	24 x 72	163	960	1029	1403	1599	
	410-2496- □	24 x 96	203	1179	1265	1737	1984	
	SINGLE PEDESTAL CREDENZA							
		411-□-2048- □	20 x 48	205	1351	1403	1668	1811
411-□-2060- □		20 x 60	223	1455	1507	1829	1990	
411-□-2072- □		20 x 72	242	1558	1616	1990	2179	
411-□-2096- □		20 x 96	278	1771	1840	2306	2553	
411-□-2448- □		24 x 48	218	1426	1484	1760	1915	
411-□-2460- □		24 x 60	238	1541	1604	1926	2099	
411-□-2472- □		24 x 72	258	1650	1725	2093	2289	
411-□-2496- □		24 x 96	298	1869	1955	2427	2674	
KNEESPACE CREDENZA								
		412-2048- □	20 x 48	300	2041	2093	2363	2496
	412-2060- □	20 x 60	318	2145	2197	2519	2685	
	412-2072- □	20 x 72	337	2254	2306	2685	2875	
	412-2096- □	20 x 96	373	2467	2530	3002	3243	
	412-2448- □	24 x 48	313	2122	2174	2450	2599	
	412-2460- □	24 x 60	333	2231	2294	2616	2795	
	412-2472- □	24 x 72	353	2346	2409	2789	2984	
	412-2496- □	24 x 96	393	2565	2645	3117	3364	

OPTIONS:

Round Grommet 3" add \$ 30 List.
Single pedestal credenza, specify pedestal at left or right:
add "L" or "R" after "411" in model number.
Substitute file/file pedestal in place of B/B/F pedestal: N/C

NOTES:

Credenzas with t-mold edge tops have t-mold edge on end panels.
Credenzas with 3mm pvc edge tops have 3mm pvc edgebanding on end panels.
Credenzas with all other top edge details have self edge on end panels.
Credenzas have Group D & E wood edge on front and end edges of top,
self edge on rear edge.
Modesty panel is positioned flush to rear.



phone: (510) 259-6217
email: info@actionlaminates.com

EDGE DETAILS

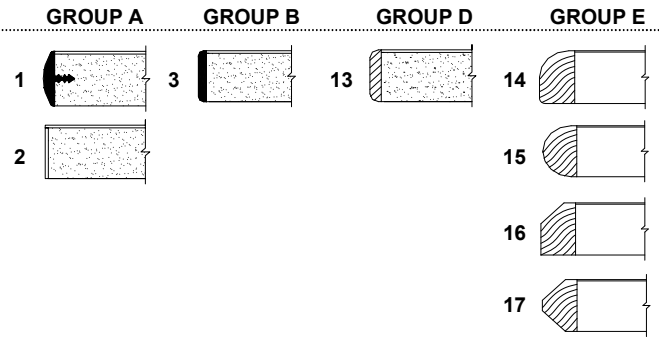

LANDMARK SERIES CRENZAS

	MODEL NUMBER	SIZE	WT.	DOORS	GROUP A	GROUP B	GROUP D	GROUP E	
STORAGE CRENZNA									
	413-2048- □	20 x 48	340	2	1501	1553	1823	1955	
	413-2060- □	20 x 60	400	4	1811	1857	2179	2346	
	413-2072- □	20 x 72	460	4	2116	2174	2542	2731	
	413-2096- □	20 x 96	580	6	2720	2789	3255	3496	
	413-2448- □	24 x 48	408	2	1691	1742	2024	2174	
	413-2460- □	24 x 60	480	4	2030	2093	2409	2588	
	413-2472- □	24 x 72	552	4	2369	2438	2812	3007	
	413-2496- □	24 x 96	696	6	3048	3134	3600	3853	
	EXECUTIVE CRENZNA								
		414-2060- □	20 x 60	370	2	2703	2749	3076	3237
414-2072- □		20 x 72	413	2	3007	3065	3439	3628	
414-2096- □		20 x 96	498	4	3761	3818	4295	4537	
414-2460- □		24 x 60	400	2	2898	2961	3283	3456	
414-2472- □		24 x 72	450	2	3237	3312	3680	3876	
414-2496- □		24 x 96	550	4	4077	4157	4635	4882	
LATERAL FILE CRENZNA									
	415-2060- □	20 x 61	400		2956	3007	3329	3490	
	415-2072- □	20 x 73	457		3220	3272	3651	3835	
	415-2084- □	20 x 85	535		3692	3761	4226	4468	
	415-2460- □	24 x 61	415		3042	3105	3427	3600	
	415-2472- □	24 x 73	475		3312	3375	3755	3950	
	415-2484- □	24 x 85	555		3789	3876	4341	4589	

OPTIONS:

Round Grommet 3" add \$ 30 List.
Substitute file/file pedestal in place of B/B/F pedestal: N/C

NOTES:

Credenzas with t-mold edge tops have t-mold edge on end panels.
Credenzas with 3mm pvc edge tops have 3mm pvc edgebanding on end panels.
Credenzas with all other top edge details have self edge on end panels.
Credenzas have Group D & E wood edge on front and end edges of top, self edge on rear edge.
Modesty panel is positioned flush to rear.
Lateral file drawers include hardware to file: one row of legal size from side-to-side, 30"w & 36"w two rows of letter size from front-to-back, 42"w three rows of letter size from front-to-back,



phone: (510) 259-6217
email: info@actionlaminates.com

EDGE DETAILS

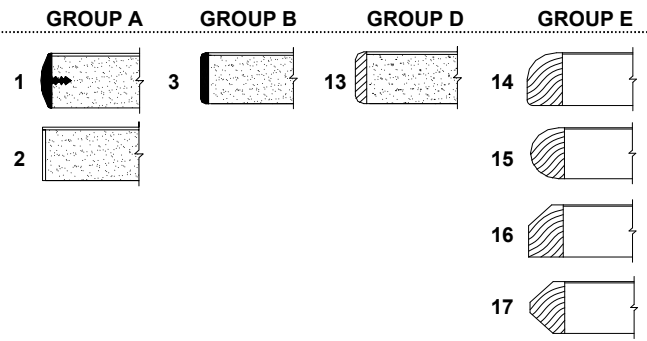

**LANDMARK SERIES
DIAGONAL CORNER UNITS**

MODEL NUMBER	SIZE	WT.	GROUP A	GROUP B	GROUP D	GROUP E
--------------	------	-----	---------	---------	---------	---------

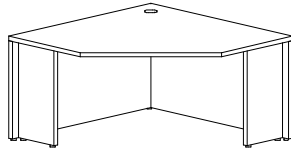

416-36-2020- □	36 x 36 x 20 x 20	124	805	914	1139	1288
416-36-2424- □	36 x 36 x 24 x 24	124	805	914	1139	1288
416-36-2024- □	36 x 36 x 20 x 24	124	805	914	1139	1288
416-36-2420- □	36 x 36 x 24 x 20	124	805	914	1139	1288

416-42-2424- □	42 x 42 x 24 x 24	145	955	1087	1403	1599
416-42-3030- □	42 x 42 x 30 x 30	145	955	1087	1403	1599
416-42-2430- □	42 x 42 x 24 x 30	145	955	1087	1403	1599
416-42-3024- □	42 x 42 x 30 x 24	145	955	1087	1403	1599



416-48-2424- □	48 x 48 x 24 x 24	172	955	1087	1403	1599
416-48-3030- □	48 x 48 x 30 x 30	172	955	1087	1403	1599
416-48-2430- □	48 x 48 x 24 x 30	172	955	1087	1403	1599
416-48-3024- □	48 x 48 x 30 x 24	172	955	1087	1403	1599

416-60-2424- □	60 x 60 x 24 x 24	226	1156	1323	1708	1955
416-60-3030- □	60 x 60 x 30 x 30	226	1156	1323	1708	1955
416-60-2430- □	60 x 60 x 24 x 30	226	1156	1323	1708	1955
416-60-3024- □	60 x 60 x 30 x 24	226	1156	1323	1708	1955

OPTIONS:

Additional Round Grommet 3" add \$ 30 List.

NOTES:

Please specify edge detail at the end of the model number.

Standard with one 3" round grommet at the corner.

Corner units with t-mold edge have t-mold edge on end panels.

Corner units with 3mm pvc edgebanding have 3mm pvc edgebanding on end panels.

Corner units with all other edge details have self edge on end panels.



phone: (510) 259-6217
email: info@actionlaminates.com

EDGE DETAILS

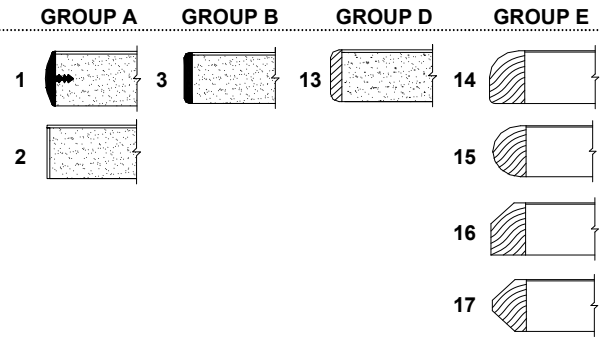

**LANDMARK SERIES
NOTCHED CORNER UNITS**

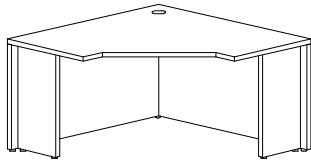
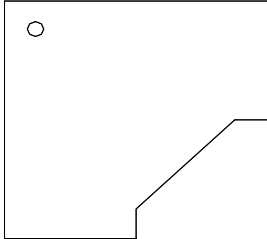
MODEL NUMBER	SIZE	WT.	GROUP A	GROUP B	GROUP D	GROUP E
 417-36-2020-□	36 x 36 x 20 x 20	124	805	914	1139	1288
417-36-2424-□	36 x 36 x 24 x 24	124	805	914	1139	1288
417-36-2024-□	36 x 36 x 20 x 24	124	805	914	1139	1288
417-36-2420-□	36 x 36 x 24 x 20	124	805	914	1139	1288
<hr/>						
417-42-2424-□	42 x 42 x 24 x 24	145	955	1087	1403	1599
417-42-3030-□	42 x 42 x 30 x 30	145	955	1087	1403	1599
417-42-2430-□	42 x 42 x 24 x 30	145	955	1087	1403	1599
417-42-3024-□	42 x 42 x 30 x 24	145	955	1087	1403	1599
<hr/>						
 417-48-2424-□	48 x 48 x 24 x 24	172	955	1087	1403	1599
417-48-3030-□	48 x 48 x 30 x 30	172	955	1087	1403	1599
417-48-2430-□	48 x 48 x 24 x 30	172	955	1087	1403	1599
417-48-3024-□	48 x 48 x 30 x 24	172	955	1087	1403	1599
<hr/>						
417-60-2424-□	60 x 60 x 24 x 24	226	1156	1323	1708	1955
417-60-3030-□	60 x 60 x 30 x 30	226	1156	1323	1708	1955
417-60-2430-□	60 x 60 x 24 x 30	226	1156	1323	1708	1955
417-60-3024-□	60 x 60 x 30 x 24	226	1156	1323	1708	1955

OPTIONS:

Additional Round Grommet 3" add \$ 30 List.

NOTES:

- Please specify edge detail at the end of the model number.
- Standard with one 3" round grommet at the corner.
- Corner units with t-mold edge have t-mold edge on end panels.
- Corner units with 3mm pvc edgebanding have 3mm pvc edgebanding on end panels.
- Corner units with all other edge details have self edge on end panels.



phone: (510) 259-6217
email: info@actionlaminates.com

EDGE DETAILS

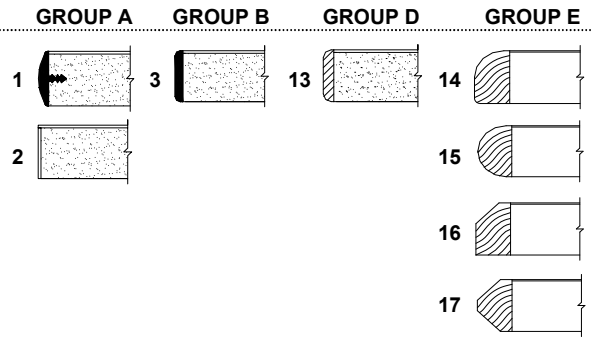

**LANDMARK SERIES
CURVED CORNER UNITS**

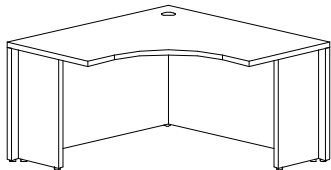
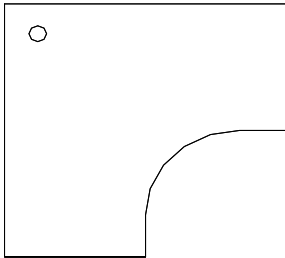
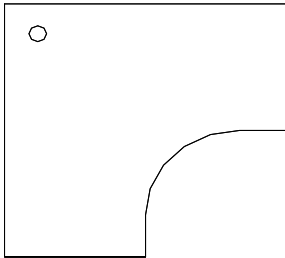
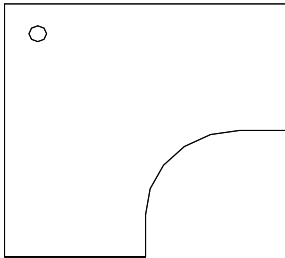
MODEL NUMBER	SIZE	WT.	GROUP A	GROUP B	GROUP D	GROUP E	
	418-36-2020-☐	36 x 36 x 20 x 20	124	805	914	1139	1288
	418-36-2424-☐	36 x 36 x 24 x 24	124	805	914	1139	1288
	418-36-2024-☐	36 x 36 x 20 x 24	124	805	914	1139	1288
	418-36-2420-☐	36 x 36 x 24 x 20	124	805	914	1139	1288
	418-42-2424-☐	42 x 42 x 24 x 24	145	955	1087	1403	1599
	418-42-3030-☐	42 x 42 x 30 x 30	145	955	1087	1403	1599
	418-42-2430-☐	42 x 42 x 24 x 30	145	955	1087	1403	1599
	418-42-3024-☐	42 x 42 x 30 x 24	145	955	1087	1403	1599
	418-48-2424-☐	48 x 48 x 24 x 24	172	955	1087	1403	1599
	418-48-3030-☐	48 x 48 x 30 x 30	172	955	1087	1403	1599
	418-48-2430-☐	48 x 48 x 24 x 30	172	955	1087	1403	1599
	418-48-3024-☐	48 x 48 x 30 x 24	172	955	1087	1403	1599
	418-60-2424-☐	60 x 60 x 24 x 24	226	1156	1323	1708	1955
	418-60-3030-☐	60 x 60 x 30 x 30	226	1156	1323	1708	1955
	418-60-2430-☐	60 x 60 x 24 x 30	226	1156	1323	1708	1955
	418-60-3024-☐	60 x 60 x 30 x 24	226	1156	1323	1708	1955

OPTIONS:

Additional Round Grommet 3" add \$ 30 List.

NOTES:

- Please specify edge detail at the end of the model number.
- Standard with one 3" round grommet at the corner.
- Corner units with t-mold edge have t-mold edge on end panels.
- Corner units with 3mm pvc edgebanding have 3mm pvc edgebanding on end panels.
- Corner units with all other edge details have self edge on end panels.



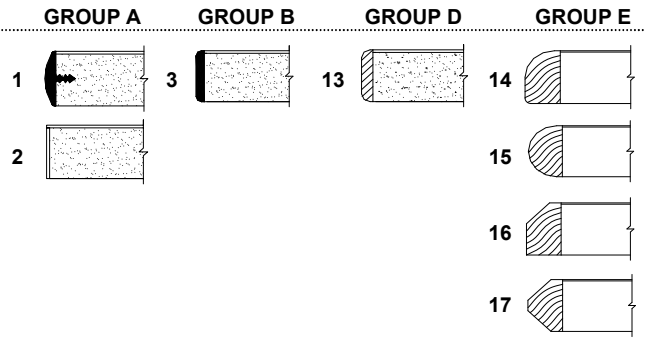

phone: (510) 259-6217
email: info@actionlaminates.com

EDGE DETAILS

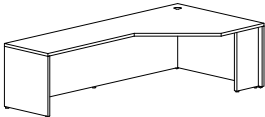
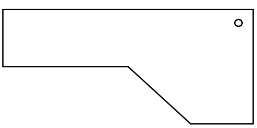

**LANDMARK SERIES
EXTENDED DIAGONAL CORNER UNITS**

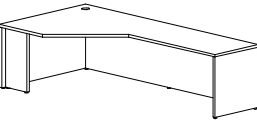
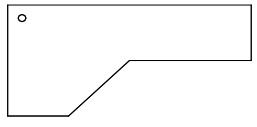
	MODEL NUMBER	SIZE	WT.	GROUP A	GROUP B	GROUP D	GROUP E
	419-□-3648-2020-□	36 x 48 x 20 x 20	159	1006	1093	1403	1576
	419-□-3648-2424-□	36 x 48 x 24 x 24	159	1006	1093	1403	1576
	419-□-3648-2024-□	36 x 48 x 20 x 24	159	1006	1093	1403	1576
	419-□-3648-2420-□	36 x 48 x 24 x 20	159	1006	1093	1403	1576
	419-□-3660-2020-□	36 x 60 x 20 x 20	178	1150	1242	1593	1794
	419-□-3660-2424-□	36 x 60 x 24 x 24	178	1150	1242	1593	1794
	419-□-3660-2024-□	36 x 60 x 20 x 24	178	1150	1242	1593	1794
	419-□-3660-2420-□	36 x 60 x 24 x 20	178	1150	1242	1593	1794
	419-□-3672-2020-□	36 x 72 x 20 x 20	197	1288	1392	1794	2018
	419-□-3672-2424-□	36 x 72 x 24 x 24	197	1288	1392	1794	2018
	419-□-3672-2024-□	36 x 72 x 20 x 24	197	1288	1392	1794	2018
	419-□-3672-2420-□	36 x 72 x 24 x 20	197	1288	1392	1794	2018
<p>Left Extension Shown</p>	419-□-3696-2020-□	36 x 96 x 20 x 20	235	1564	1685	2174	2450
	419-□-3696-2424-□	36 x 96 x 24 x 24	235	1564	1685	2174	2450
	419-□-3696-2024-□	36 x 96 x 20 x 24	235	1564	1685	2174	2450
	419-□-3696-2420-□	36 x 96 x 24 x 20	235	1564	1685	2174	2450
	419-□-4860-2424-□	48 x 60 x 24 x 24	202	1328	1438	1834	2053
	419-□-4860-3030-□	48 x 60 x 30 x 30	202	1328	1438	1834	2053
	419-□-4860-2430-□	48 x 60 x 24 x 30	202	1328	1438	1834	2053
	419-□-4860-3024-□	48 x 60 x 30 x 24	202	1328	1438	1834	2053
	419-□-4872-2424-□	48 x 72 x 24 x 24	221	1489	1610	2047	2294
	419-□-4872-3030-□	48 x 72 x 30 x 30	221	1489	1610	2047	2294
	419-□-4872-2430-□	48 x 72 x 24 x 30	221	1489	1610	2047	2294
	419-□-4872-3024-□	48 x 72 x 30 x 24	221	1489	1610	2047	2294
<p>Right Extension Shown</p>	419-□-4896-2424-□	48 x 96 x 24 x 24	250	1811	1955	2478	2777
	419-□-4896-3030-□	48 x 96 x 30 x 30	250	1811	1955	2478	2777
	419-□-4896-2430-□	48 x 96 x 24 x 30	250	1811	1955	2478	2777
	419-□-4896-3024-□	48 x 96 x 30 x 24	250	1811	1955	2478	2777

OPTIONS:

Additional Round Grommet 3" add \$ 30 List.

NOTES:

Please specify left or right extension: add "L" or "R" after "419" in model number.

Please specify edge detail at the end of the model number. Standard with one 3" round grommet at the corner.

Corner units with t-mold edge have t-mold edge on end panels.

Corner units with 3mm pvc edgebanding have 3mm pvc edgebanding on end panels.

Corner units with all other edge details have self edge on end panels.



phone: (510) 259-6217
email: info@actionlaminates.com

EDGE DETAILS

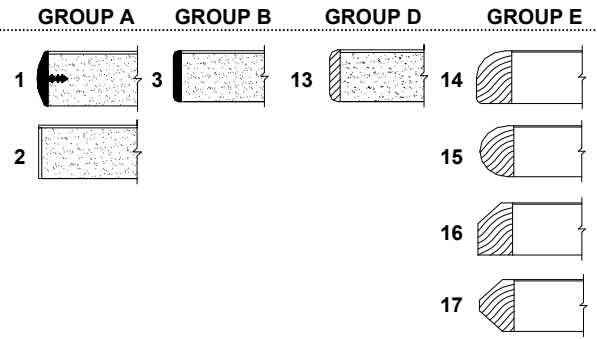

**LANDMARK SERIES
EXTENDED NOTCHED CORNER UNITS**

	MODEL NUMBER	SIZE	WT.	GROUP A	GROUP B	GROUP D	GROUP E
<p>Left Extension Shown</p>	420-□-4860-2424-□	48 x 60 x 24 x 24	202	1328	1438	1834	2053
	420-□-4860-3030-□	48 x 60 x 30 x 30	202	1328	1438	1834	2053
	420-□-4860-2430-□	48 x 60 x 24 x 30	202	1328	1438	1834	2053
	420-□-4860-3024-□	48 x 60 x 30 x 24	202	1328	1438	1834	2053
<p>Right Extension Shown</p>	420-□-4872-2424-□	48 x 72 x 24 x 24	221	1489	1610	2047	2294
	420-□-4872-3030-□	48 x 72 x 30 x 30	221	1489	1610	2047	2294
	420-□-4872-2430-□	48 x 72 x 24 x 30	221	1489	1610	2047	2294
	420-□-4872-3024-□	48 x 72 x 30 x 24	221	1489	1610	2047	2294
<p>Left Extension Shown</p>	420-□-4896-2424-□	48 x 96 x 24 x 24	260	1811	1955	2478	2777
	420-□-4896-3030-□	48 x 96 x 30 x 30	260	1811	1955	2478	2777
	420-□-4896-2430-□	48 x 96 x 24 x 30	260	1811	1955	2478	2777
	420-□-4896-3024-□	48 x 96 x 30 x 24	260	1811	1955	2478	2777
<p>Right Extension Shown</p>	420-□-6072-2424-□	60 x 72 x 24 x 24	258	1691	1834	2300	2576
	420-□-6072-3030-□	60 x 72 x 30 x 30	258	1691	1834	2300	2576
	420-□-6072-2430-□	60 x 72 x 24 x 30	258	1691	1834	2300	2576
	420-□-6072-3024-□	60 x 72 x 30 x 24	258	1691	1834	2300	2576
<p>Left Extension Shown</p>	420-□-6084-2424-□	60 x 84 x 24 x 24	279	2053	2231	2783	3099
	420-□-6084-3030-□	60 x 84 x 30 x 30	279	2053	2231	2783	3099
	420-□-6084-2430-□	60 x 84 x 24 x 30	279	2053	2231	2783	3099
	420-□-6084-3024-□	60 x 84 x 30 x 24	279	2053	2231	2783	3099
<p>Right Extension Shown</p>	420-□-6096-2424-□	60 x 96 x 24 x 24	301	2053	2231	2783	3099
	420-□-6096-3030-□	60 x 96 x 30 x 30	301	2053	2231	2783	3099
	420-□-6096-2430-□	60 x 96 x 24 x 30	301	2053	2231	2783	3099
	420-□-6096-3024-□	60 x 96 x 30 x 24	301	2053	2231	2783	3099

OPTIONS:

Additional Round Grommet 3" add \$ 30 List.

NOTES:

Please specify left or right extension: add "L" or "R" after "420" in model number.

Please specify edge detail at the end of the model number.

Standard with one 3" round grommet at the corner.

Corner units with t-mold edge have t-mold edge on end panels.

Corner units with 3mm pvc edgebanding have 3mm pvc edgebanding on end panels.

Corner units with all other edge details have self edge on end panels.



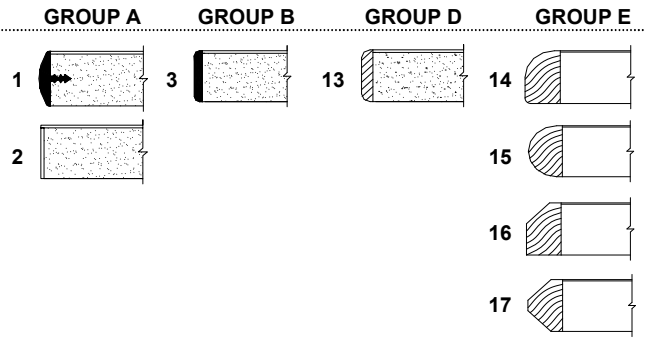

phone: (510) 259-6217
email: info@actionlaminates.com

EDGE DETAILS

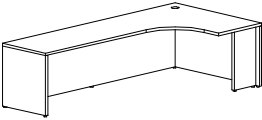
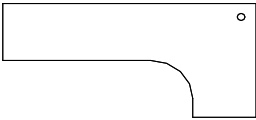
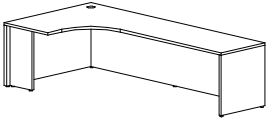
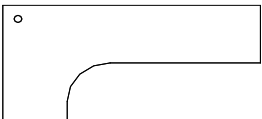

**LANDMARK SERIES
EXTENDED CURVED CORNER UNITS**

	MODEL NUMBER	SIZE	WT.	GROUP A	GROUP B	GROUP D	GROUP E
	421-□-3648-2020-□	36 x 48 x 20 x 20	159	1006	1093	1403	1576
	421-□-3648-2424-□	36 x 48 x 24 x 24	159	1006	1093	1403	1576
	421-□-3648-2024-□	36 x 48 x 20 x 24	159	1006	1093	1403	1576
	421-□-3648-2420-□	36 x 48 x 24 x 20	159	1006	1093	1403	1576
	421-□-3660-2020-□	36 x 60 x 20 x 20	178	1150	1242	1593	1794
	421-□-3660-2424-□	36 x 60 x 24 x 24	178	1150	1242	1593	1794
	421-□-3660-2024-□	36 x 60 x 20 x 24	178	1150	1242	1593	1794
	421-□-3660-2420-□	36 x 60 x 24 x 20	178	1150	1242	1593	1794
Left Extension Shown	421-□-3672-2020-□	36 x 72 x 20 x 20	197	1288	1392	1794	2018
	421-□-3672-2424-□	36 x 72 x 24 x 24	197	1288	1392	1794	2018
	421-□-3672-2024-□	36 x 72 x 20 x 24	197	1288	1392	1794	2018
	421-□-3672-2420-□	36 x 72 x 24 x 20	197	1288	1392	1794	2018
	421-□-3696-2020-□	36 x 96 x 20 x 20	235	1564	1685	2174	2450
	421-□-3696-2424-□	36 x 96 x 24 x 24	235	1564	1685	2174	2450
	421-□-3696-2024-□	36 x 96 x 20 x 24	235	1564	1685	2174	2450
	421-□-3696-2420-□	36 x 96 x 24 x 20	235	1564	1685	2174	2450
	421-□-4860-2424-□	48 x 60 x 24 x 24	202	1328	1438	1834	2053
	421-□-4860-3030-□	48 x 60 x 30 x 30	202	1328	1438	1834	2053
	421-□-4860-2430-□	48 x 60 x 24 x 30	202	1328	1438	1834	2053
	421-□-4860-3024-□	48 x 60 x 30 x 24	202	1328	1438	1834	2053
Right Extension Shown	421-□-4872-2424-□	48 x 72 x 24 x 24	221	1489	1610	2047	2294
	421-□-4872-3030-□	48 x 72 x 30 x 30	221	1489	1610	2047	2294
	421-□-4872-2430-□	48 x 72 x 24 x 30	221	1489	1610	2047	2294
	421-□-4872-3024-□	48 x 72 x 30 x 24	221	1489	1610	2047	2294
	421-□-4896-2424-□	48 x 96 x 24 x 24	250	1811	1955	2478	2777
	421-□-4896-3030-□	48 x 96 x 30 x 30	250	1811	1955	2478	2777
	421-□-4896-2430-□	48 x 96 x 24 x 30	250	1811	1955	2478	2777
	421-□-4896-3024-□	48 x 96 x 30 x 24	250	1811	1955	2478	2777

OPTIONS:

Additional Round Grommet 3" add \$ 30 List.

NOTES:

Please specify left or right extension: add "L" or "R" after "421" in model number.

Please specify edge detail at the end of the model number. Standard with one 3" round grommet at the corner.

Corner units with t-mold edge have t-mold edge on end panels.

Corner units with 3mm pvc edgebanding have 3mm pvc edgebanding on end panels.

Corner units with all other edge details have self edge on end panels.



phone: (510) 259-6217
email: info@actionlaminates.com

EDGE DETAILS

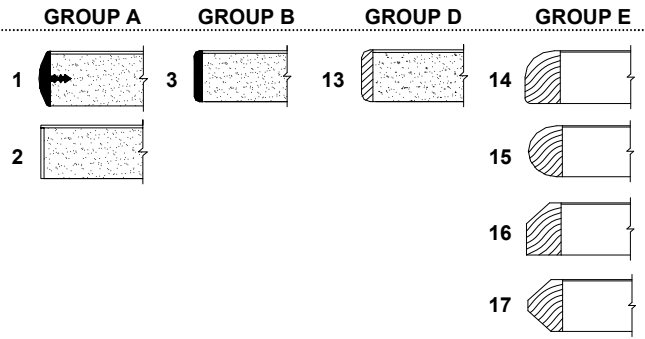

**LANDMARK SERIES
EXTENDED DIAGONAL CORNER UNITS
WITH PEDESTAL**

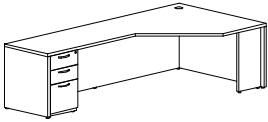
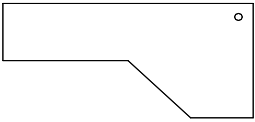
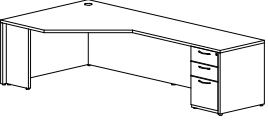
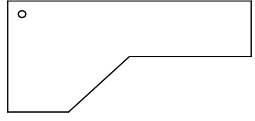
	MODEL NUMBER	SIZE	WT.	GROUP A	GROUP B	GROUP D	GROUP E
	422-□-3660-2020-□	36 x 60 x 20 x 20	273	1840	1932	2283	2484
	422-□-3660-2424-□	36 x 60 x 24 x 24	273	1840	1932	2283	2484
	422-□-3660-2024-□	36 x 60 x 20 x 24	273	1840	1932	2283	2484
	422-□-3660-2420-□	36 x 60 x 24 x 20	273	1840	1932	2283	2484
	422-□-3672-2020-□	36 x 72 x 20 x 20	292	1972	2082	2484	2708
	422-□-3672-2424-□	36 x 72 x 24 x 24	292	1972	2082	2484	2708
	422-□-3672-2024-□	36 x 72 x 20 x 24	292	1972	2082	2484	2708
	422-□-3672-2420-□	36 x 72 x 24 x 20	292	1972	2082	2484	2708
Left Extension Shown	422-□-3696-2020-□	36 x 96 x 20 x 20	330	2254	2375	2864	3140
	422-□-3696-2424-□	36 x 96 x 24 x 24	330	2254	2375	2864	3140
	422-□-3696-2024-□	36 x 96 x 20 x 24	330	2254	2375	2864	3140
	422-□-3696-2420-□	36 x 96 x 24 x 20	330	2254	2375	2864	3140
	422-□-4872-2424-□	48 x 72 x 24 x 24	316	2179	2300	2743	2984
	422-□-4872-3030-□	48 x 72 x 30 x 30	316	2179	2300	2743	2984
	422-□-4872-2430-□	48 x 72 x 24 x 30	316	2179	2300	2743	2984
	422-□-4872-3024-□	48 x 72 x 30 x 24	316	2179	2300	2743	2984
	422-□-4896-2424-□	48 x 96 x 24 x 24	345	2496	2645	3168	3462
	422-□-4896-3030-□	48 x 96 x 30 x 30	345	2496	2645	3168	3462
	422-□-4896-2430-□	48 x 96 x 24 x 30	345	2496	2645	3168	3462
	422-□-4896-3024-□	48 x 96 x 30 x 24	345	2496	2645	3168	3462
Right Extension Shown							

OPTIONS:

Additional Round Grommet 3" add \$ 30 List.
Substitute F/F pedestal in place of B/B/F pedestal: N/C

NOTES:

Please specify left or right extension: add "L" or "R" after "422" in model number.
Please specify edge detail at the end of the model number.
Standard with one 3" round grommet at the corner.
Corner units with t-mold edge have t-mold edge on end panels.
Corner units with 3mm pvc edgebanding have 3mm pvc edgebanding on end panels.
Corner units with all other edge details have self edge on end panels.



phone: (510) 259-6217
email: info@actionlaminates.com

EDGE DETAILS

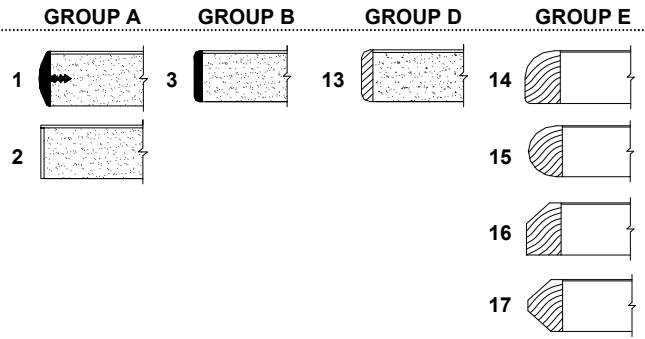

**LANDMARK SERIES
EXTENDED NOTCHED CORNER UNITS
WITH PEDESTAL**

	MODEL NUMBER	SIZE	WT.	GROUP A	GROUP B	GROUP D	GROUP E
	423-□-4860-2424-□	48 x 60 x 24 x 24	297	2024	2133	2524	2743
	423-□-4860-3030-□	48 x 60 x 30 x 30	297	2024	2133	2524	2743
	423-□-4860-2430-□	48 x 60 x 24 x 30	297	2024	2133	2524	2743
	423-□-4860-3024-□	48 x 60 x 30 x 24	297	2024	2133	2524	2743
	423-□-4872-2424-□	48 x 72 x 24 x 24	316	2179	2300	2743	2990
	423-□-4872-3030-□	48 x 72 x 30 x 30	316	2179	2300	2743	2990
	423-□-4872-2430-□	48 x 72 x 24 x 30	316	2179	2300	2743	2990
	423-□-4872-3024-□	48 x 72 x 30 x 24	316	2179	2300	2743	2990
<p>Left Extension Shown</p>	423-□-4896-2424-□	48 x 96 x 24 x 24	355	2496	2645	3168	3462
	423-□-4896-3030-□	48 x 96 x 30 x 30	355	2496	2645	3168	3462
	423-□-4896-2430-□	48 x 96 x 24 x 30	355	2496	2645	3168	3462
	423-□-4896-3024-□	48 x 96 x 30 x 24	355	2496	2645	3168	3462
<p>Right Extension Shown</p>	423-□-6072-2424-□	60 x 72 x 24 x 24	353	2381	2524	2996	3266
	423-□-6072-3030-□	60 x 72 x 30 x 30	353	2381	2524	2996	3266
	423-□-6072-2430-□	60 x 72 x 24 x 30	353	2381	2524	2996	3266
	423-□-6072-3024-□	60 x 72 x 30 x 24	353	2381	2524	2996	3266
<p>Left Extension Shown</p>	423-□-6084-2424-□	60 x 84 x 24 x 24	374	2743	2921	3467	3789
	423-□-6084-3030-□	60 x 84 x 30 x 30	374	2743	2921	3467	3789
	423-□-6084-2430-□	60 x 84 x 24 x 30	374	2743	2921	3467	3789
	423-□-6084-3024-□	60 x 84 x 30 x 24	374	2743	2921	3467	3789
<p>Right Extension Shown</p>	423-□-6096-2424-□	60 x 96 x 24 x 24	396	2743	2921	3467	3789
	423-□-6096-3030-□	60 x 96 x 30 x 30	396	2743	2921	3467	3789
	423-□-6096-2430-□	60 x 96 x 24 x 30	396	2743	2921	3467	3789
	423-□-6096-3024-□	60 x 96 x 30 x 24	396	2743	2921	3467	3789

OPTIONS:

Additional Round Grommet 3" add \$ 30 List.
Substitute F/F pedestal in place of B/B/F pedestal: N/C

NOTES:

Please specify left or right extension: add "L" or "R" after "423" in model number.
Please specify edge detail at the end of the model number.
Standard with one 3" round grommet at the corner.
Corner units with t-mold edge have t-mold edge on end panels.
Corner units with 3mm pvc edgebanding have 3mm pvc edgebanding on end panels.
Corner units with all other edge details have self edge on end panels.





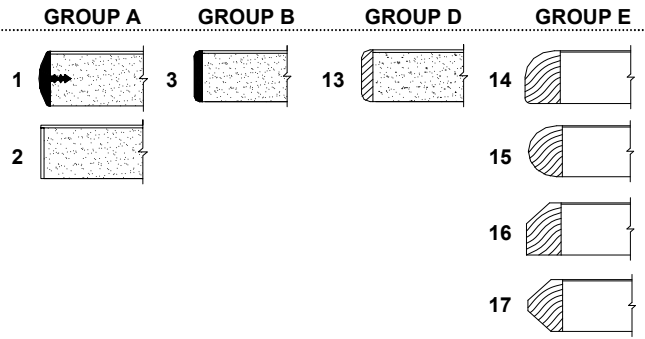

phone: (510) 259-6217
email: info@actionlaminates.com

EDGE DETAILS

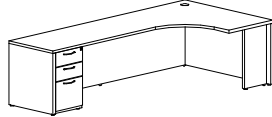
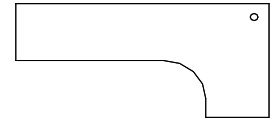

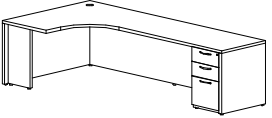
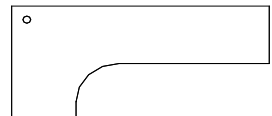
**LANDMARK SERIES
EXTENDED CURVED CORNER UNITS
WITH PEDESTAL**

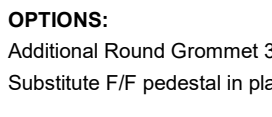
	MODEL NUMBER	SIZE	WT.	GROUP A	GROUP B	GROUP D	GROUP E
	424-□-3648-2020-□	36 x 48 x 20 x 20	254	1702	1783	2093	2266
	424-□-3648-2424-□	36 x 48 x 24 x 24	254	1702	1783	2093	2266
	424-□-3648-2024-□	36 x 48 x 20 x 24	254	1702	1783	2093	2266
	424-□-3648-2420-□	36 x 48 x 24 x 20	254	1702	1783	2093	2266
	424-□-3660-2020-□	36 x 60 x 20 x 20	273	1840	1932	2283	2484
	424-□-3660-2424-□	36 x 60 x 24 x 24	273	1840	1932	2283	2484
	424-□-3660-2024-□	36 x 60 x 20 x 24	273	1840	1932	2283	2484
	424-□-3660-2420-□	36 x 60 x 24 x 20	273	1840	1932	2283	2484
<p>Left Extension Shown</p> 	424-□-3672-2020-□	36 x 72 x 20 x 20	292	1972	2082	2484	2708
	424-□-3672-2424-□	36 x 72 x 24 x 24	292	1972	2082	2484	2708
	424-□-3672-2024-□	36 x 72 x 20 x 24	292	1972	2082	2484	2708
	424-□-3672-2420-□	36 x 72 x 24 x 20	292	1972	2082	2484	2708
	424-□-3696-2020-□	36 x 96 x 20 x 20	330	2254	2375	2869	3140
	424-□-3696-2424-□	36 x 96 x 24 x 24	330	2254	2375	2869	3140
	424-□-3696-2024-□	36 x 96 x 20 x 24	330	2254	2375	2869	3140
	424-□-3696-2420-□	36 x 96 x 24 x 20	330	2254	2375	2869	3140
	424-□-4860-2424-□	48 x 60 x 24 x 24	297	2024	2133	2524	2743
	424-□-4860-3030-□	48 x 60 x 30 x 30	297	2024	2133	2524	2743
	424-□-4860-2430-□	48 x 60 x 24 x 30	297	2024	2133	2524	2743
	424-□-4860-3024-□	48 x 60 x 30 x 24	297	2024	2133	2524	2743
	424-□-4872-2424-□	48 x 72 x 24 x 24	316	2179	2300	2737	2984
	424-□-4872-3030-□	48 x 72 x 30 x 30	316	2179	2300	2737	2984
	424-□-4872-2430-□	48 x 72 x 24 x 30	316	2179	2300	2737	2984
	424-□-4872-3024-□	48 x 72 x 30 x 24	316	2179	2300	2737	2984
<p>Right Extension Shown</p> 	424-□-4896-2424-□	48 x 96 x 24 x 24	345	2496	2645	3168	3462
	424-□-4896-3030-□	48 x 96 x 30 x 30	345	2496	2645	3168	3462
	424-□-4896-2430-□	48 x 96 x 24 x 30	345	2496	2645	3168	3462
	424-□-4896-3024-□	48 x 96 x 30 x 24	345	2496	2645	3168	3462

OPTIONS:

Additional Round Grommet 3" add \$ 30 List.
Substitute F/F pedestal in place of B/B/F pedestal: N/C

NOTES:

Please specify left or right extension: add "L" or "R" after "424" in model number.
Please specify edge detail at the end of the model number.
Standard with one 3" round grommet at the corner.
Corner units with t-mold edge have t-mold edge on end panels.
Corner units with 3mm pvc edgebanding have 3mm pvc edgebanding on end panels.
Corner units with all other edge details have self edge on end panels.



phone: (510) 259-6217
email: info@actionlaminates.com

EDGE DETAILS

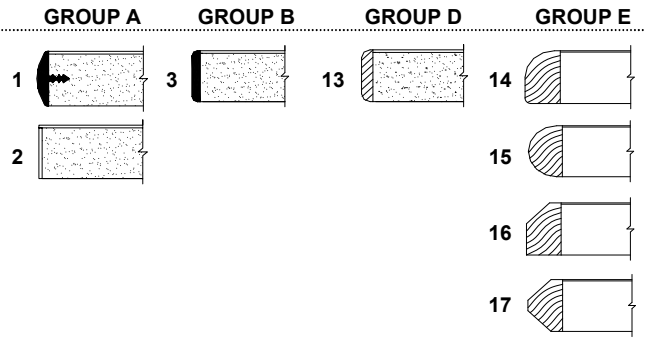

**LANDMARK SERIES
EXTENDED DIAGONAL CORNER UNITS
WITH 30" WIDE LATERAL FILE**

MODEL NUMBER	SIZE	WT.	GROUP A	GROUP B	GROUP D	GROUP E
--------------	------	-----	---------	---------	---------	---------

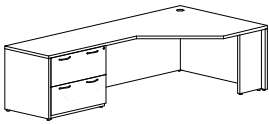

425-□-3672-2020-□	36 x 72 x 20 x 20	332	2381	2484	2892	3111
425-□-3672-2424-□	36 x 72 x 24 x 24	332	2381	2484	2892	3111
425-□-3672-2024-□	36 x 72 x 20 x 24	332	2381	2484	2892	3111
425-□-3672-2420-□	36 x 72 x 24 x 20	332	2381	2484	2892	3111

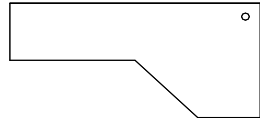

425-□-3696-2020-□	36 x 96 x 20 x 20	370	2657	2783	3266	3542
425-□-3696-2424-□	36 x 96 x 24 x 24	370	2657	2783	3266	3542
425-□-3696-2024-□	36 x 96 x 20 x 24	370	2657	2783	3266	3542
425-□-3696-2420-□	36 x 96 x 24 x 20	370	2657	2783	3266	3542

Left Extension Shown

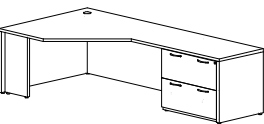

425-□-4884-2424-□	48 x 84 x 24 x 24	385	2904	3053	3577	3870
425-□-4884-3030-□	48 x 84 x 30 x 30	385	2904	3053	3577	3870
425-□-4884-2430-□	48 x 84 x 24 x 30	385	2904	3053	3577	3870
425-□-4884-3024-□	48 x 84 x 30 x 24	385	2904	3053	3577	3870
425-□-4896-2424-□	48 x 96 x 24 x 24	385	2904	3053	3577	3870
425-□-4896-3030-□	48 x 96 x 30 x 30	385	2904	3053	3577	3870
425-□-4896-2430-□	48 x 96 x 24 x 30	385	2904	3053	3577	3870
425-□-4896-3024-□	48 x 96 x 30 x 24	385	2904	3053	3577	3870

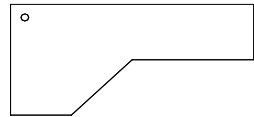

Right Extension Shown

OPTIONS:

Additional Round Grommet 3" add \$ 30 List.

NOTES:

Please specify left or right extension: add "L" or "R" after "425" in model number.

Please specify edge detail at the end of the model number.

Standard with one 3" round grommet at the corner.

Corner units with t-mold edge have t-mold edge on end panels.

Corner units with 3mm pvc edgebanding have 3mm pvc edgebanding on end panels.

Corner units with all other edge details have self edge on end panels.



phone: (510) 259-6217
email: info@actionlaminates.com

EDGE DETAILS

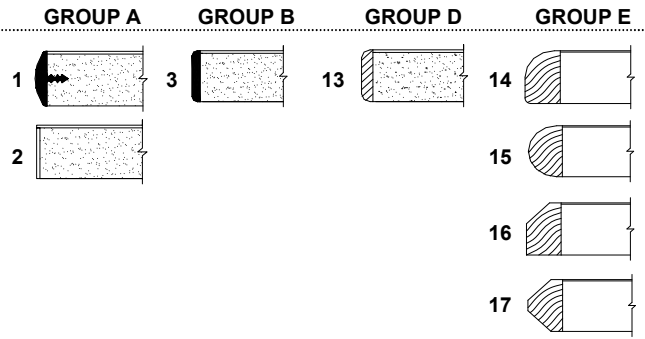

**LANDMARK SERIES
EXTENDED NOTCHED CORNER UNITS
WITH 30" WIDE LATERAL FILE**

MODEL NUMBER	SIZE	WT.	GROUP A	GROUP B	GROUP D	GROUP E
--------------	------	-----	---------	---------	---------	---------

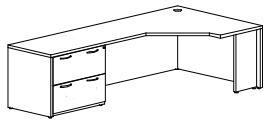

426-□-4884-2424-□	48 x 84 x 24 x 24	395	2904	3053	3577	3870
426-□-4884-3030-□	48 x 84 x 30 x 30	395	2904	3053	3577	3870
426-□-4884-2430-□	48 x 84 x 24 x 30	395	2904	3053	3577	3870
426-□-4884-3024-□	48 x 84 x 30 x 24	395	2904	3053	3577	3870

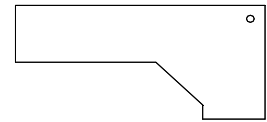

426-□-4896-2424-□	48 x 96 x 24 x 24	395	2904	3053	3577	3870
426-□-4896-3030-□	48 x 96 x 30 x 30	395	2904	3053	3577	3870
426-□-4896-2430-□	48 x 96 x 24 x 30	395	2904	3053	3577	3870
426-□-4896-3024-□	48 x 96 x 30 x 24	395	2904	3053	3577	3870

Left Extension Shown

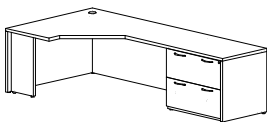

426-□-6096-2424-□	60 x 96 x 24 x 24	436	3151	3329	3876	4198
426-□-6096-3030-□	60 x 96 x 30 x 30	436	3151	3329	3876	4198
426-□-6096-2430-□	60 x 96 x 24 x 30	436	3151	3329	3876	4198
426-□-6096-3024-□	60 x 96 x 30 x 24	436	3151	3329	3876	4198

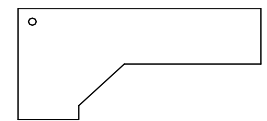

Right Extension Shown

OPTIONS:

Additional Round Grommet 3" add \$ 30 List.

NOTES:

- Please specify left or right extension: add "L" or "R" after "426" in model number.
- Please specify edge detail at the end of the model number. Standard with one 3" round grommet at the corner.
- Corner units with t-mold edge have t-mold edge on end panels.
- Corner units with 3mm pvc edgebanding have 3mm pvc edgebanding on end panels.
- Corner units with all other edge details have self edge on end panels.



phone: (510) 259-6217
email: info@actionlaminates.com

EDGE DETAILS

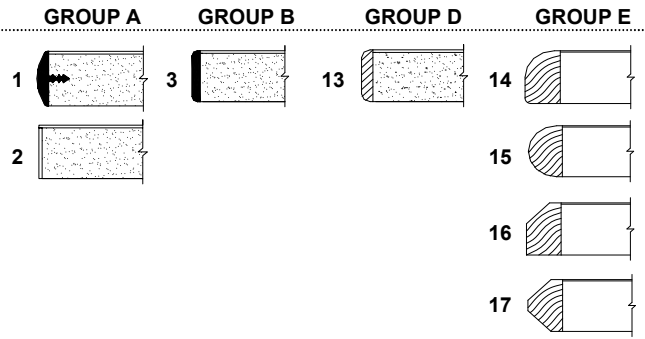

**LANDMARK SERIES
EXTENDED CURVED CORNER UNITS
WITH 30" WIDE LATERAL FILE**

MODEL NUMBER	SIZE	WT.	GROUP A	GROUP B	GROUP D	GROUP E
--------------	------	-----	---------	---------	---------	---------

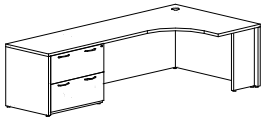

427-□-3672-2020-□	36 x 72 x 20 x 20	332	2381	2484	2892	3111
427-□-3672-2424-□	36 x 72 x 24 x 24	332	2381	2484	2892	3111
427-□-3672-2024-□	36 x 72 x 20 x 24	332	2381	2484	2892	3111
427-□-3672-2420-□	36 x 72 x 24 x 20	332	2381	2484	2892	3111



427-□-3684-2020-□	36 x 84 x 20 x 20	370	2657	2783	3266	3542
427-□-3684-2424-□	36 x 84 x 24 x 24	370	2657	2783	3266	3542
427-□-3684-2024-□	36 x 84 x 20 x 24	370	2657	2783	3266	3542
427-□-3684-2420-□	36 x 84 x 24 x 20	370	2657	2783	3266	3542

Left Extension Shown

427-□-3696-2020-□	36 x 96 x 20 x 20	370	2657	2783	3266	3542
427-□-3696-2424-□	36 x 96 x 24 x 24	370	2657	2783	3266	3542
427-□-3696-2024-□	36 x 96 x 20 x 24	370	2657	2783	3266	3542
427-□-3696-2420-□	36 x 96 x 24 x 20	370	2657	2783	3266	3542

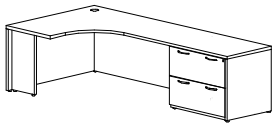

427-□-4884-2424-□	48 x 84 x 24 x 24	385	2904	3053	3577	3870
427-□-4884-3030-□	48 x 84 x 30 x 30	385	2904	3053	3577	3870
427-□-4884-2430-□	48 x 84 x 24 x 30	385	2904	3053	3577	3870
427-□-4884-3024-□	48 x 84 x 30 x 24	385	2904	3053	3577	3870

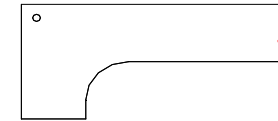

427-□-4896-2424-□	48 x 96 x 24 x 24	385	2904	3053	3577	3870
427-□-4896-3030-□	48 x 96 x 30 x 30	385	2904	3053	3577	3870
427-□-4896-2430-□	48 x 96 x 24 x 30	385	2904	3053	3577	3870
427-□-4896-3024-□	48 x 96 x 30 x 24	385	2904	3053	3577	3870

Right Extension Shown

OPTIONS:

Additional Round Grommet 3" add \$ 30 List.

NOTES:

Please specify left or right extension: add "L" or "R" after "427" in model number.

Please specify edge detail at the end of the model number. Standard with one 3" round grommet at the corner.

Corner units with t-mold edge have t-mold edge on end panels.

Corner units with 3mm pvc edgebanding have 3mm pvc edgebanding on end panels.

Corner units with all other edge details have self edge on end panels.



phone: (510) 259-6217
email: info@actionlaminates.com

EDGE DETAILS

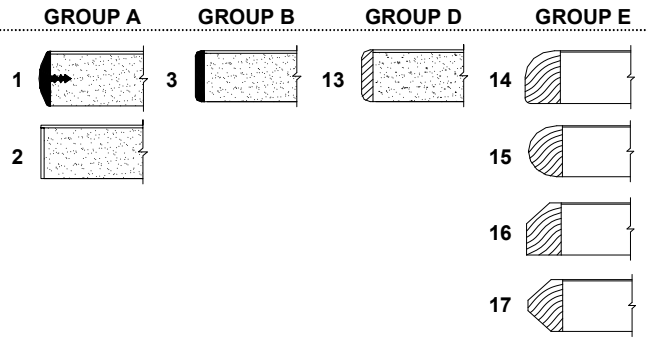

**LANDMARK SERIES
PENINSULA UNITS**

	MODEL NUMBER	SIZE	WT.	GROUP A	GROUP B	GROUP E	GROUP D
BULLET SHAPE							
	434-2460-□	24 x 60	131	857	909	1340	1564
	434-2472-□	24 x 72	151	966	1035	1524	1771
	434-2484-□	24 x 84	171	1190	1265	1898	2202
	434-2496-□	24 x 96	191	1190	1265	1898	2202
	434-3060-□	30 x 60	148	943	1006	1472	1702
	434-3072-□	30 x 72	170	1058	1139	1656	1926
	434-3084-□	30 x 84	192	1305	1397	2041	2369
	434-3096-□	30 x 96	214	1305	1397	2041	2369
	434-3660-□	36 x 60	165	1041	1121	1599	1852
	434-3672-□	36 x 72	189	1167	1259	1794	2082
	434-3684-□	36 x 84	213	1432	1547	2208	2559
	434-3696-□	36 x 96	238	1432	1547	2208	2559
	CONVEX SHAPE						
	435-2460-□	24 x 60	131	857	909	1340	1564
	435-2472-□	24 x 72	151	966	1035	1524	1771
	435-2484-□	24 x 84	171	1190	1265	1898	2202
	435-2496-□	24 x 96	191	1190	1265	1898	2202
	435-3060-□	30 x 60	148	943	1006	1472	1702
	435-3072-□	30 x 72	170	1058	1139	1656	1926
	435-3084-□	30 x 84	192	1305	1397	2041	2369
	435-3096-□	30 x 96	214	1305	1397	2041	2369
	435-3660-□	36 x 60	165	1041	1121	1599	1852
	435-3672-□	36 x 72	189	1167	1259	1794	2082
	435-3684-□	36 x 84	213	1432	1547	2208	2559
	435-3696-□	36 x 96	238	1432	1547	2208	2559

OPTIONS:

- 3" Round Grommet, add \$ 27 List.
- Upgrade to 4" base, add \$ 60 List.
- Upgrade to 6" base, add \$ 135 List.

NOTES:

- Please specify edge detail at the end of the model number.
- Peninsula units with t-mold edge have t-mold edge on end panels.
- Peninsula units with 3mm pvc edgebanding have 3mm pvc edgebanding on end panels.
- Peninsula units with all other edge details have self edge on end panels.
- Standard with 3" black column base.





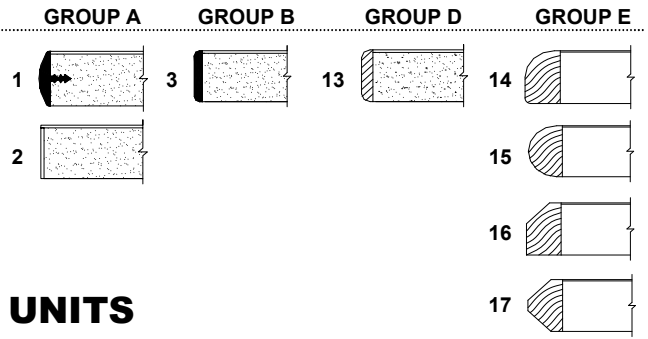

phone: (510) 259-6217
email: info@actionlaminates.com

EDGE DETAILS

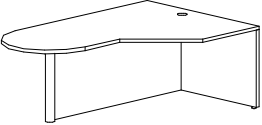
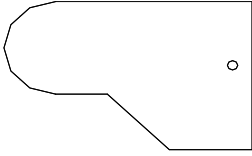

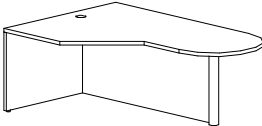
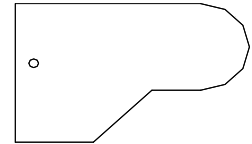
**LANDMARK SERIES
EXTENDED DIAGONAL CORNER BULLET UNITS**

	MODEL NUMBER	SIZE	WT.	GROUP A	GROUP B	GROUP D	GROUP E
	428-3660-2020-	36 x 60 x 20 x 20	150	1081	1167	1645	1898
	428-3660-2424-	36 x 60 x 24 x 24	150	1081	1167	1645	1898
	428-3660-2024-	36 x 60 x 20 x 24	150	1081	1167	1645	1898
	428-3660-2420-	36 x 60 x 24 x 20	150	1081	1167	1645	1898
	428-3672-2020-	36 x 72 x 20 x 20	170	1219	1317	1852	2133
	428-3672-2424-	36 x 72 x 24 x 24	170	1219	1317	1852	2133
	428-3672-2024-	36 x 72 x 20 x 24	170	1219	1317	1852	2133
	428-3672-2420-	36 x 72 x 24 x 20	170	1219	1317	1852	2133
	428-3696-2020-	36 x 96 x 20 x 20	210	1495	1610	2271	2616
	428-3696-2424-	36 x 96 x 24 x 24	210	1495	1610	2271	2616
	428-3696-2024-	36 x 96 x 20 x 24	210	1495	1610	2271	2616
	428-3696-2420-	36 x 96 x 24 x 20	210	1495	1610	2271	2616
	428-4860-2424-	48 x 60 x 24 x 24	174	1265	1374	1898	2179
	428-4860-3030-	48 x 60 x 30 x 30	174	1265	1374	1898	2179
	428-4860-2430-	48 x 60 x 24 x 30	174	1265	1374	1898	2179
	428-4860-3024-	48 x 60 x 30 x 24	174	1265	1374	1898	2179
	428-4872-2424-	48 x 72 x 24 x 24	194	1420	1541	2128	2438
	428-4872-3030-	48 x 72 x 30 x 30	194	1420	1541	2128	2438
	428-4872-2430-	48 x 72 x 24 x 30	194	1420	1541	2128	2438
	428-4872-3024-	48 x 72 x 30 x 24	194	1420	1541	2128	2438
	428-4896-2424-	48 x 96 x 24 x 24	234	1742	1880	2588	2961
	428-4896-3030-	48 x 96 x 30 x 30	234	1742	1880	2588	2961
	428-4896-2430-	48 x 96 x 24 x 30	234	1742	1880	2588	2961
	428-4896-3024-	48 x 96 x 30 x 24	234	1742	1880	2588	2961

OPTIONS:

- Additional Round Grommet 3" add \$ 30 List.
- Upgrade to 4" base, add \$ 60 List.
- Upgrade to 6" base, add \$ 135 List.

NOTES:

- Please specify left or right extension: add "L" or "R" after "428" in model number.
- Please specify edge detail at the end of the model number.
- Standard with one 3" round grommet at the corner.
- Corner units with t-mold edge have t-mold edge on end panels.
- Corner units with 3mm pvc edgebanding have 3mm pvc edgebanding on end panels.
- Corner units with all other edge details have self edge on end panels.
- Standard with 3" black column base.



phone: (510) 259-6217
email: info@actionlaminates.com

EDGE DETAILS

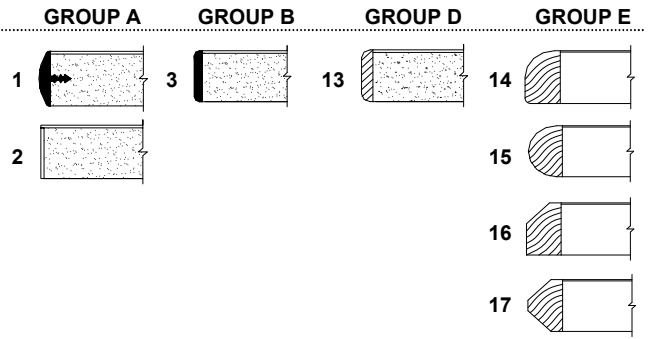

**LANDMARK SERIES
EXTENDED NOTCHED CORNER BULLET UNITS**

	MODEL NUMBER	SIZE	WT.	GROUP A	GROUP B	GROUP D	GROUP E
	429-□-4860-2424-□	48 x 60 x 24 x 24	174	1265	1374	1898	2179
	429-□-4860-3030-□	48 x 60 x 30 x 30	174	1265	1374	1898	2179
	429-□-4860-2430-□	48 x 60 x 24 x 30	174	1265	1374	1898	2179
	429-□-4860-3024-□	48 x 60 x 30 x 24	174	1265	1374	1898	2179
	429-□-4872-2424-□	48 x 72 x 24 x 24	194	1420	1541	2128	2438
	429-□-4872-3030-□	48 x 72 x 30 x 30	194	1420	1541	2128	2438
	429-□-4872-2430-□	48 x 72 x 24 x 30	194	1420	1541	2128	2438
	429-□-4872-3024-□	48 x 72 x 30 x 24	194	1420	1541	2128	2438
	429-□-4896-2424-□	48 x 96 x 24 x 24	234	1742	1880	2588	2961
	429-□-4896-3030-□	48 x 96 x 30 x 30	234	1742	1880	2588	2961
	429-□-4896-2430-□	48 x 96 x 24 x 30	234	1742	1880	2588	2961
	429-□-4896-3024-□	48 x 96 x 30 x 24	234	1742	1880	2588	2961
Left Extension Shown							
	429-□-6072-2424-□	60 x 72 x 24 x 24	231	1622	1760	2398	2743
	429-□-6072-3030-□	60 x 72 x 30 x 30	231	1622	1760	2398	2743
	429-□-6072-2430-□	60 x 72 x 24 x 30	231	1622	1760	2398	2743
	429-□-6072-3024-□	60 x 72 x 30 x 24	231	1622	1760	2398	2743
	429-□-6084-2424-□	60 x 84 x 24 x 24	253	1990	2162	2904	3312
	429-□-6084-3030-□	60 x 84 x 30 x 30	253	1990	2162	2904	3312
	429-□-6084-2430-□	60 x 84 x 24 x 30	253	1990	2162	2904	3312
	429-□-6084-3024-□	60 x 84 x 30 x 24	253	1990	2162	2904	3312
	429-□-6096-2424-□	60 x 96 x 24 x 24	275	1990	2162	2904	3312
	429-□-6096-3030-□	60 x 96 x 30 x 30	275	1990	2162	2904	3312
	429-□-6096-2430-□	60 x 96 x 24 x 30	275	1990	2162	2904	3312
	429-□-6096-3024-□	60 x 96 x 30 x 24	275	1990	2162	2904	3312
Right Extension Shown							

OPTIONS:

- Additional Round Grommet 3" add \$ 30 List.
- Upgrade to 4" base, add \$ 60 List.
- Upgrade to 6" base, add \$ 135 List.

NOTES:

- Please specify left or right extension: add "L" or "R" after "429" in model number.
- Please specify edge detail at the end of the model number.
- Standard with one 3" round grommet at the corner.
- Corner units with t-mold edge have t-mold edge on end panels.
- Corner units with 3mm pvc edgebanding have 3mm pvc edgebanding on end panels.
- Corner units with all other edge details have self edge on end panels.
- Standard with 3" black column base.



phone: (510) 259-6217
email: info@actionlaminates.com

EDGE DETAILS

GROUP A

GROUP B

GROUP D

GROUP E

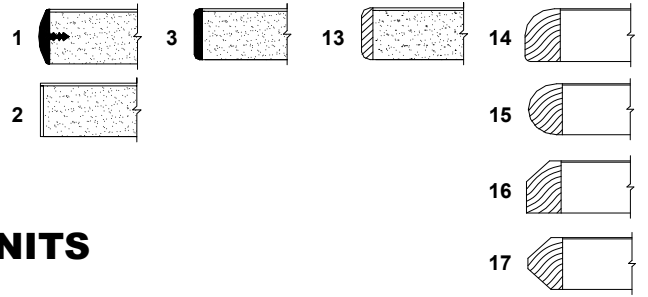

**LANDMARK SERIES
EXTENDED CURVED CORNER BULLET UNITS**

	MODEL NUMBER	SIZE	WT.	GROUP A	GROUP B	GROUP D	GROUP E
	430-3660-2020-3660-2020	36 x 60 x 20 x 20	150	1081	1167	1645	1903
	430-3660-2424-3660-2424	36 x 60 x 24 x 24	150	1081	1167	1645	1903
	430-3660-2024-3660-2024	36 x 60 x 20 x 24	150	1081	1167	1645	1903
	430-3660-2420-3660-2420	36 x 60 x 24 x 20	150	1081	1167	1645	1903
	430-3672-2020-3672-2020	36 x 72 x 20 x 20	170	1219	1317	1852	2133
	430-3672-2424-3672-2424	36 x 72 x 24 x 24	170	1219	1317	1852	2133
	430-3672-2024-3672-2024	36 x 72 x 20 x 24	170	1219	1317	1852	2133
	430-3672-2420-3672-2420	36 x 72 x 24 x 20	170	1219	1317	1852	2133
	430-3696-2020-3696-2020	36 x 96 x 20 x 20	210	1495	1610	2271	2616
	430-3696-2424-3696-2424	36 x 96 x 24 x 24	210	1495	1610	2271	2616
	430-3696-2024-3696-2024	36 x 96 x 20 x 24	210	1495	1610	2271	2616
	430-3696-2420-3696-2420	36 x 96 x 24 x 20	210	1495	1610	2271	2616
	430-4860-2424-4860-2424	48 x 60 x 24 x 24	174	1265	1374	1898	2179
	430-4860-3030-4860-3030	48 x 60 x 30 x 30	174	1265	1374	1898	2179
	430-4860-2430-4860-2430	48 x 60 x 24 x 30	174	1265	1374	1898	2179
	430-4860-3024-4860-3024	48 x 60 x 30 x 24	174	1265	1374	1898	2179
	430-4872-2424-4872-2424	48 x 72 x 24 x 24	194	1420	1541	2128	2444
	430-4872-3030-4872-3030	48 x 72 x 30 x 30	194	1420	1541	2128	2444
	430-4872-2430-4872-2430	48 x 72 x 24 x 30	194	1420	1541	2128	2444
	430-4872-3024-4872-3024	48 x 72 x 30 x 24	194	1420	1541	2128	2444
	430-4896-2424-4896-2424	48 x 96 x 24 x 24	234	1742	1880	2588	2961
	430-4896-3030-4896-3030	48 x 96 x 30 x 30	234	1742	1880	2588	2961
	430-4896-2430-4896-2430	48 x 96 x 24 x 30	234	1742	1880	2588	2961
	430-4896-3024-4896-3024	48 x 96 x 30 x 24	234	1742	1880	2588	2961

OPTIONS:

- Additional Round Grommet 3" add \$ 30 List.
- Upgrade to 4" base, add \$ 60 List.
- Upgrade to 6" base, add \$ 135 List.

NOTES:

- Please specify left or right extension: add "L" or "R" after "430" in model number.
- Please specify edge detail at the end of the model number.
- Standard with one 3" round grommet at the corner.
- Corner units with t-mold edge have t-mold edge on end panels.
- Corner units with 3mm pvc edgebanding have 3mm pvc edgebanding on end panels.
- Corner units with all other edge details have self edge on end panels.
- Standard with 3" black column base.



phone: (510) 259-6217
email: info@actionlaminates.com

EDGE DETAILS

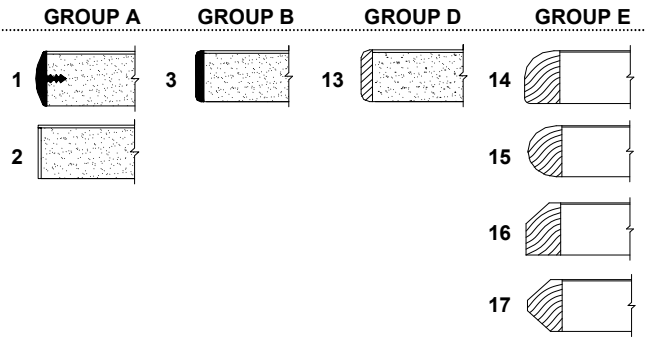

**LANDMARK SERIES
EXTENDED DIAGONAL CORNER P-SHAPED UNITS**

MODEL NUMBER	SIZE	WT.	GROUP A	GROUP B	GROUP D	GROUP E
A X B X C X D X E						
431-□-3672-2424-36-□	36 x 72 x 24 x 24 x 36	192	1403	1524	2110	2427
431-□-3684-2424-36-□	36 x 84 x 24 x 24 x 36	219	1725	1869	2570	2950
431-□-3696-2424-36-□	36 x 96 x 24 x 24 x 36	244	1725	1869	2570	2950
431-□-4272-2424-36-□	42 x 72 x 24 x 24 x 36	213	1576	1719	2283	2588
431-□-4272-3024-36-□	42 x 72 x 30 x 24 x 36	213	1576	1719	2283	2588
431-□-4296-2424-36-□	42 x 96 x 24 x 24 x 36	237	1938	2110	2852	3266
431-□-4296-3024-36-□	42 x 96 x 30 x 24 x 36	237	1938	2110	2852	3266
431-□-4284-2424-42-□	42 x 84 x 24 x 24 x 42	240	1938	2110	2852	3266
431-□-4284-3030-42-□	42 x 84 x 30 x 30 x 42	240	1938	2110	2852	3266
431-□-4296-2424-42-□	42 x 96 x 24 x 24 x 42	268	1938	2110	2852	3266
431-□-4296-3030-42-□	42 x 96 x 30 x 30 x 42	268	1938	2110	2852	3266
431-□-4896-3030-42-□	48 x 96 x 30 x 30 x 42	292	1972	2139	2887	3301

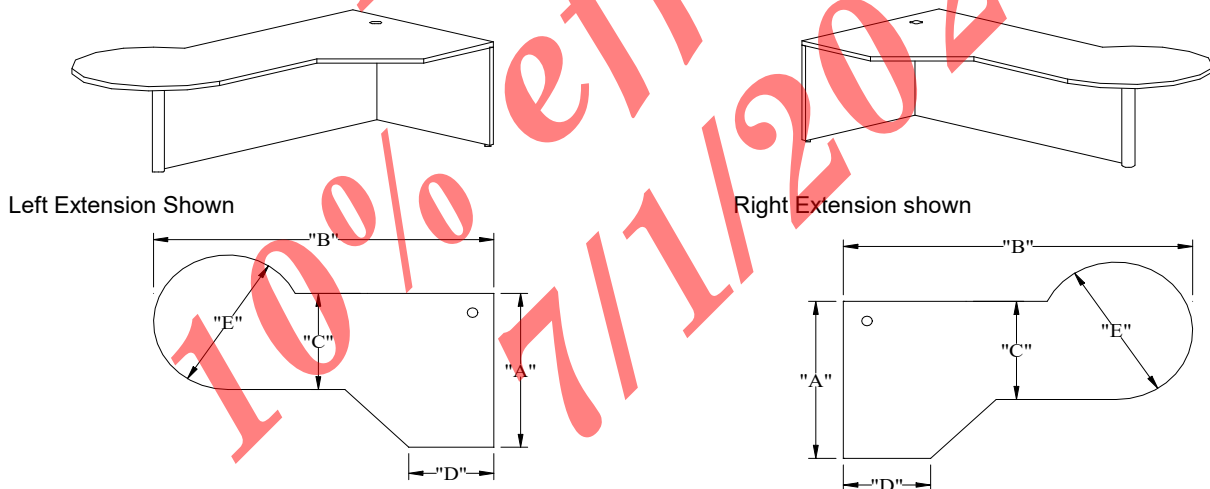

OPTIONS:

Additional Round Grommet 3" add \$ 30 List.
Upgrade to 6" base, add \$ 80 List.

NOTES:

Please specify left or right extension: add "L" or "R" after "431" in model number.
Please specify edge detail at the end of the model number.
Standard with one 3" round grommet at the corner.
Corner units with t-mold edge have t-mold edge on end panels.
Corner units with 3mm pvc edgebanding have 3mm pvc edgebanding on end panels.
Corner units with all other edge details have self edge on end panels.
Standard with 4" black column base.



phone: (510) 259-6217
email: info@actionlaminates.com

EDGE DETAILS

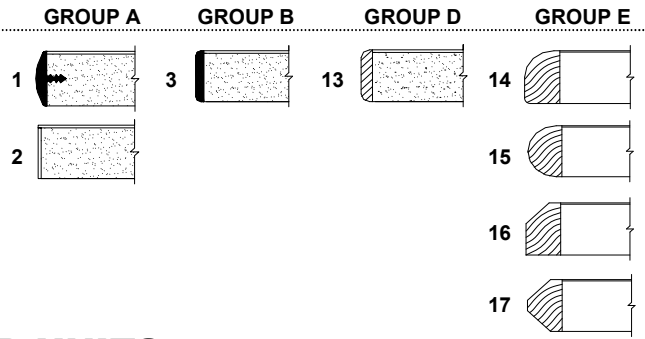

**LANDMARK SERIES
EXTENDED NOTCHED CORNER P-SHAPED UNITS**

MODEL NUMBER	SIZE	WT.	GROUP A	GROUP B	GROUP D	GROUP E
A X B X C X D X E						
432-□-3672-2424-36-□	36 x 72 x 24 x 24 x 36	192	1403	1524	2110	2427
432-□-3684-2424-36-□	36 x 84 x 24 x 24 x 36	219	1725	1869	2570	2950
432-□-3696-2424-36-□	36 x 96 x 24 x 24 x 36	244	1725	1869	2570	2950
432-□-4272-2424-36-□	42 x 72 x 24 x 24 x 36	213	1576	1719	2283	2588
432-□-4272-3024-36-□	42 x 72 x 30 x 24 x 36	213	1576	1719	2283	2588
432-□-4296-2424-36-□	42 x 96 x 24 x 24 x 36	237	1938	2110	2852	3266
432-□-4296-3024-36-□	42 x 96 x 30 x 24 x 36	237	1938	2110	2852	3266
432-□-4284-2424-42-□	42 x 84 x 24 x 24 x 42	240	1938	2110	2852	3266
432-□-4284-3030-42-□	42 x 84 x 30 x 30 x 42	240	1938	2110	2852	3266
432-□-4296-2424-42-□	42 x 96 x 24 x 24 x 42	268	1938	2110	2852	3266
432-□-4296-3030-42-□	42 x 96 x 30 x 30 x 42	268	1938	2110	2852	3266
432-□-4896-3030-42-□	48 x 96 x 30 x 30 x 42	292	1972	2139	2887	3301

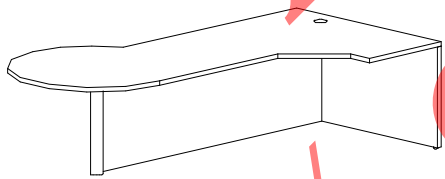

Left Extension Shown

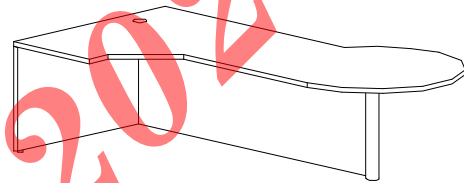

Right Extension shown

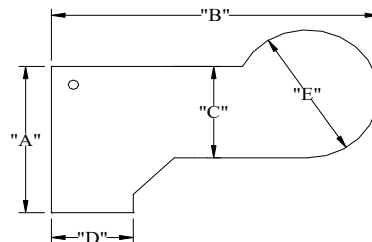
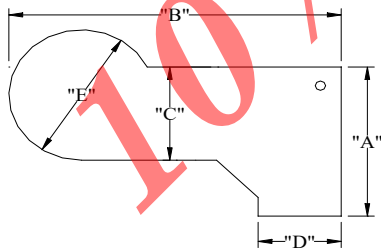

OPTIONS:

Additional Round Grommet 3" add \$ 30 List.
Upgrade to 6" base, add \$ 80 List.

NOTES:

Please specify left or right extension: add "L" or "R" after "432" in model number.
Please specify edge detail at the end of the model number.
Standard with one 3" round grommet at the corner.
Corner units with t-mold edge have t-mold edge on end panels.
Corner units with 3mm pvc edgebanding have 3mm pvc edgebanding on end panels.
Corner units with all other edge details have self edge on end panels.
Standard with 4" black column base.



phone: (510) 259-6217
email: info@actionlaminates.com

EDGE DETAILS

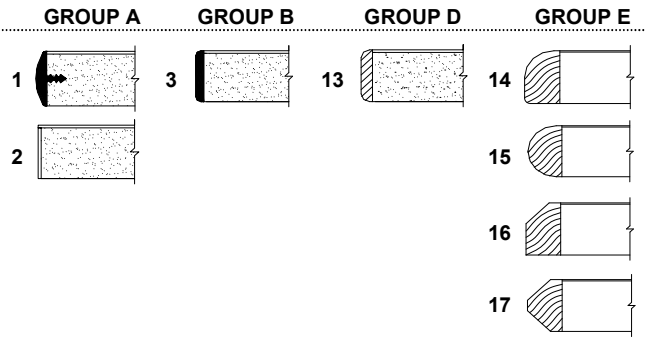

**LANDMARK SERIES
EXTENDED CURVED CORNER P-SHAPED UNITS**

MODEL NUMBER	SIZE	WT.	GROUP A	GROUP B	GROUP D	GROUP E
A X B X C X D X E						
433-□-3672-2424-36-□	36 x 72 x 24 x 24 x 36	192	1403	1524	2110	2427
433-□-3684-2424-36-□	36 x 84 x 24 x 24 x 36	219	1725	1869	2570	2950
433-□-3696-2424-36-□	36 x 96 x 24 x 24 x 36	244	1725	1869	2570	2950
433-□-4272-2424-36-□	42 x 72 x 24 x 24 x 36	213	1576	1719	2283	2588
433-□-4272-3024-36-□	42 x 72 x 30 x 24 x 36	213	1576	1719	2283	2588
433-□-4296-2424-36-□	42 x 96 x 24 x 24 x 36	237	1938	2110	2852	3266
433-□-4296-3024-36-□	42 x 96 x 30 x 24 x 36	237	1938	2110	2852	3266
433-□-4284-2424-42-□	42 x 84 x 24 x 24 x 42	240	1938	2110	2852	3266
433-□-4284-3030-42-□	42 x 84 x 30 x 30 x 42	240	1938	2110	2852	3266
433-□-4296-2424-42-□	42 x 96 x 24 x 24 x 42	268	1938	2110	2852	3266
433-□-4296-3030-42-□	42 x 96 x 30 x 30 x 42	268	1938	2110	2852	3266
433-□-4896-3030-42-□	48 x 96 x 30 x 30 x 42	292	1972	2139	2887	3301

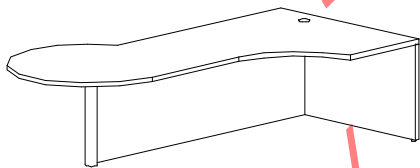

Left Extension Shown

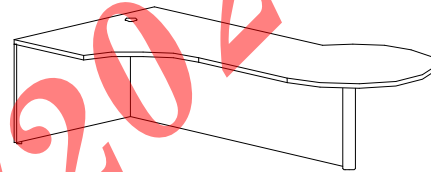
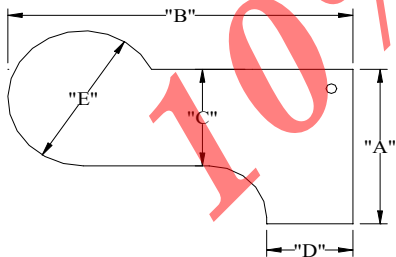

Right Extension shown

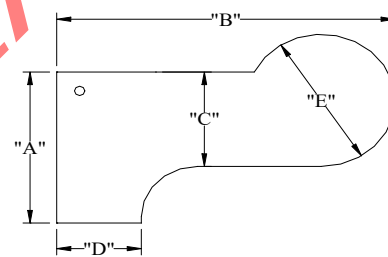

OPTIONS:

Additional Round Grommet 3" add \$ 30 List.
Upgrade to 6" base, add \$ 80 List.

NOTES:

Please specify left or right extension: add "L" or "R" after "433" in model number.
Please specify edge detail at the end of the model number.
Standard with one 3" round grommet at the corner.
Corner units with t-mold edge have t-mold edge on end panels.
Corner units with 3mm pvc edgebanding have 3mm pvc edgebanding on end panels.
Corner units with all other edge details have self edge on end panels.
Standard with 4" black column base.



phone: (510) 259-6217
email: info@actionlaminates.com

LANDMARK SERIES BRIDGE UNITS

EDGE DETAILS

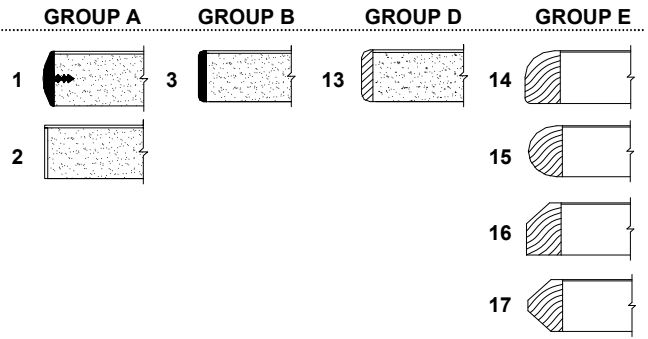

MODEL NUMBER	SIZE	WT.	GROUP A	GROUP B	GROUP D	GROUP E
438-2024-□	20 x 24	37	334	351	541	627
438-2030-□	20 x 30	46	380	403	615	713
438-2036-□	20 x 36	55	420	443	679	799
438-2042-□	20 x 42	64	512	529	822	966
438-2048-□	20 x 48	74	512	529	822	966
438-2060-□	20 x 60	92	621	644	989	1156
438-2072-□	20 x 72	110	730	765	1156	1340
438-2084-□	20 x 84	129	955	995	1495	1731
438-2096-□	20 x 96	147	955	995	1495	1731
<hr/>						
438-2424-□	24 x 24	40	334	351	541	627
438-2430-□	24 x 30	50	380	403	615	713
438-2436-□	24 x 36	60	420	443	679	799
438-2442-□	24 x 42	70	512	529	822	966
438-2448-□	24 x 48	80	512	529	822	966
438-2460-□	24 x 60	99	621	644	989	1156
438-2472-□	24 x 72	119	730	765	1156	1340
438-2484-□	24 x 84	139	955	995	1495	1731
438-2496-□	24 x 96	159	955	995	1495	1731
<hr/>						
438-3030-□	30 x 30	55	414	437	696	817
438-3036-□	30 x 36	66	454	495	765	897
438-3042-□	30 x 42	77	552	587	914	1075
438-3048-□	30 x 48	89	552	587	914	1075
438-3060-□	30 x 60	111	673	713	1087	1282
438-3072-□	30 x 72	133	799	845	1265	1484
438-3084-□	30 x 84	155	1041	1098	1622	1886
438-3096-□	30 x 96	177	1041	1098	1622	1886

OPTIONS:

3" Round Grommet, add \$30 List.

NOTES:

Please specify edge detail at the end of the model number.
Standard with flat brackets for mounting.



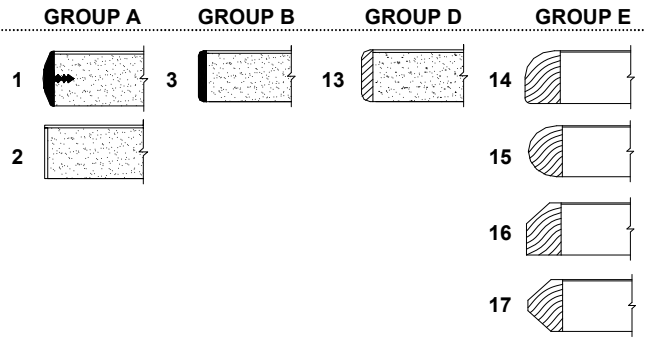

phone: (510) 259-6217
email: info@actionlaminates.com

EDGE DETAILS



**LANDMARK SERIES
RETURN UNITS**

	MODEL NUMBER	SIZE	WT.	GROUP A	GROUP B	GROUP D	GROUP E
 <p>Left Return</p>	439-□-2024-□	20 x 24	55	449	477	673	771
	439-□-2030-□	20 x 30	64	495	529	742	857
	439-□-2036-□	20 x 36	73	535	575	805	932
	439-□-2042-□	20 x 42	82	621	656	955	1104
	439-□-2048-□	20 x 48	92	621	656	955	1104
	439-□-2060-□	20 x 60	110	730	776	1121	1294
	439-□-2072-□	20 x 72	128	845	891	1294	1489
	439-□-2084-□	20 x 84	147	1064	1127	1622	1869
	439-□-2096-□	20 x 96	165	1064	1127	1622	1869
	 <p>Right Return</p>	439-□-2424-□	24 x 24	62	449	477	673
439-□-2430-□		24 x 30	71	495	529	742	857
439-□-2436-□		24 x 36	81	535	575	805	932
439-□-2442-□		24 x 42	91	621	656	955	1104
439-□-2448-□		24 x 48	101	621	656	955	1104
439-□-2460-□		24 x 60	121	730	776	1121	1294
439-□-2472-□		24 x 72	141	845	891	1294	1489
439-□-2484-□		24 x 84	161	1064	1127	1622	1869
439-□-2496-□		24 x 96	181	1064	1127	1622	1869
		439-□-3030-□	30 x 30	83	558	610	845
	439-□-3036-□	30 x 36	94	610	650	914	1052
	439-□-3042-□	30 x 42	105	696	753	1064	1219
	439-□-3048-□	30 x 48	116	696	753	1064	1219
	439-□-3060-□	30 x 60	138	822	880	1242	1420
	439-□-3072-□	30 x 72	160	943	1001	1415	1622
	439-□-3084-□	30 x 84	182	1190	1265	1765	2030
	439-□-3096-□	30 x 96	204	1190	1265	1765	2030

OPTIONS:

3" Round Grommet, add \$30 List.

NOTES:

- Please specify left or right return: add "L" or "R" after "439" in model number.
- Please specify edge detail at the end of the model number.
- Standard with flat bracket for mounting.
- Return units with t-mold edge have t-mold edge on end panels.
- Return units with 3mm pvc edgebanding have 3mm pvc edgebanding on end panels.
- Return units with all other edge details have self edge on end panels.



phone: (510) 259-6217
email: info@actionlaminates.com

EDGE DETAILS

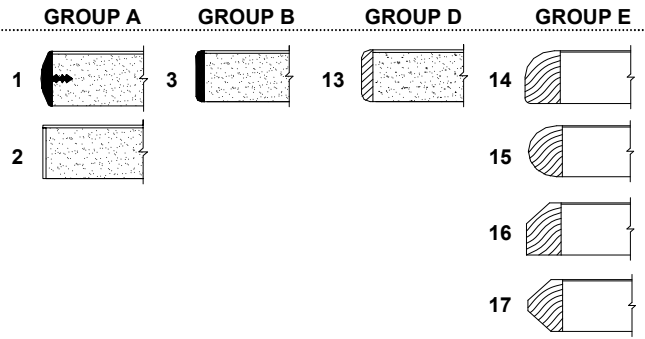

**LANDMARK SERIES
RETURN UNITS
WITH PEDESTAL**

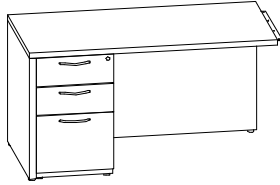
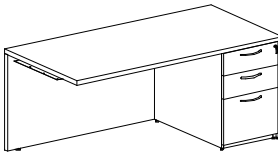
	MODEL NUMBER	SIZE	WT.	GROUP A	GROUP B	GROUP D	GROUP E
 <p>Left Return</p>	440-□-2024-□	20 x 24	150	1144	1173	1369	1461
	440-□-2030-□	20 x 30	159	1179	1219	1438	1547
	440-□-2036-□	20 x 36	168	1225	1265	1501	1622
	440-□-2042-□	20 x 42	177	1311	1346	1645	1794
	440-□-2048-□	20 x 48	187	1311	1346	1645	1794
	440-□-2060-□	20 x 60	205	1420	1472	1817	1984
	440-□-2072-□	20 x 72	223	1530	1587	1984	2179
	440-□-2084-□	20 x 84	242	1754	1823	2312	2565
	440-□-2096-□	20 x 96	260	1754	1823	2312	2565
	 <p>Right Return</p>	440-□-2424-□	24 x 24	157	1144	1173	1369
440-□-2430-□		24 x 30	166	1179	1219	1438	1547
440-□-2436-□		24 x 36	176	1225	1265	1501	1622
440-□-2442-□		24 x 42	186	1311	1346	1645	1794
440-□-2448-□		24 x 48	196	1311	1346	1645	1794
440-□-2460-□		24 x 60	216	1420	1472	1817	1984
440-□-2472-□		24 x 72	236	1530	1587	1984	2179
440-□-2484-□		24 x 84	256	1754	1823	2312	2565
440-□-2496-□		24 x 96	276	1754	1823	2312	2565
		440-□-3030-□	30 x 30	178	1248	1300	1530
	440-□-3036-□	30 x 36	189	1300	1340	1604	1742
	440-□-3042-□	30 x 42	200	1392	1438	1754	1915
	440-□-3048-□	30 x 48	211	1392	1438	1754	1915
	440-□-3060-□	30 x 60	233	1512	1570	1932	2110
	440-□-3072-□	30 x 72	255	1633	1696	2105	2312
	440-□-3084-□	30 x 84	277	1875	1955	2461	2720
	440-□-3096-□	30 x 96	299	1875	1955	2461	2720

OPTIONS:

3" Round Grommet, add \$30 List.
Substitute F/F pedestal in place of B/B/F pedestal: N/C

NOTES:

Please specify left or right return: add "L" or "R" after "440" in model number.
Please specify edge detail at the end of the model number.
Standard with flat bracket for mounting.
Return units with t-mold edge have t-mold edge on end panels.
Return units with 3mm pvc edgebanding have 3mm pvc edgebanding on end panels.
Return units with all other edge details have self edge on end panels.



phone: (510) 259-6217
email: info@actionlaminates.com

EDGE DETAILS

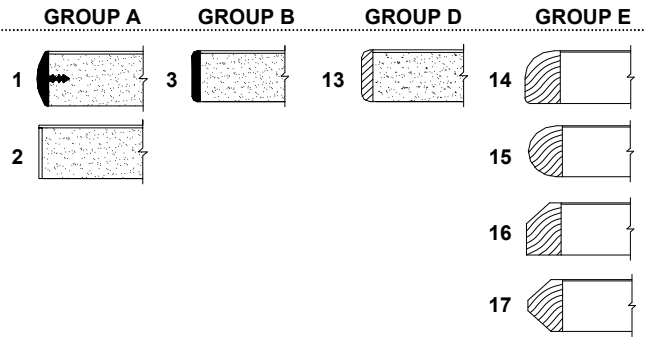

**LANDMARK SERIES
RETURN UNITS
WITH LATERAL FILE**

MODEL NUMBER	SIZE	WT.	GROUP A	GROUP B	GROUP D	GROUP E
--------------	------	-----	---------	---------	---------	---------

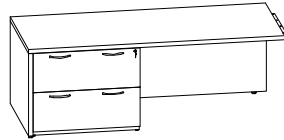

441-□-2036-□	20 x 36	208	1633	1668	1915	2030
441-□-2042-□	20 x 42	217	1719	1754	2047	2202
441-□-2048-□	20 x 48	227	1719	1754	2047	2202
441-□-2060-□	20 x 60	245	1829	1869	2220	2386
441-□-2072-□	20 x 72	263	1938	1990	2386	2582
441-□-2084-□	20 x 84	282	2162	2225	2720	2967
441-□-2096-□	20 x 96	300	2162	2225	2720	2967

Left Return

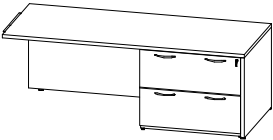

441-□-2436-□	24 x 36	216	1633	1668	1915	2030
441-□-2442-□	24 x 42	226	1719	1754	2047	2202
441-□-2448-□	24 x 48	236	1719	1754	2047	2202
441-□-2460-□	24 x 60	256	1829	1869	2220	2386
441-□-2472-□	24 x 72	276	1938	1990	2386	2582
441-□-2484-□	24 x 84	296	2162	2225	2720	2967
441-□-2496-□	24 x 96	316	2162	2225	2720	2967

Right Return

441-□-3036-□	30 x 36	229	1702	1748	2013	2145
441-□-3042-□	30 x 42	240	1794	1846	2162	2317
441-□-3048-□	30 x 48	251	1794	1846	2162	2317
441-□-3060-□	30 x 60	273	1921	1972	2340	2519
441-□-3072-□	30 x 72	295	2036	2099	2513	2720
441-□-3084-□	30 x 84	317	2283	2363	2864	3128
441-□-3096-□	30 x 96	339	2283	2363	2864	3128

OPTIONS:

3" Round Grommet, add \$30 List.

NOTES:

Please specify left or right return: add "L" or "R" after "441" in model number.

Please specify edge detail at the end of the model number.

Standard with flat bracket for mounting.

Return units with t-mold edge have t-mold edge on end panels.

Return units with 3mm pvc edgebanding have 3mm pvc edgebanding on end panels.

Return units with all other edge details have self edge on end panels.

Standard with 30" wide lateral file pedestal with lock.



phone: (510) 259-6217
email: info@actionlaminates.com

LANDMARK SERIES LATERAL FILES

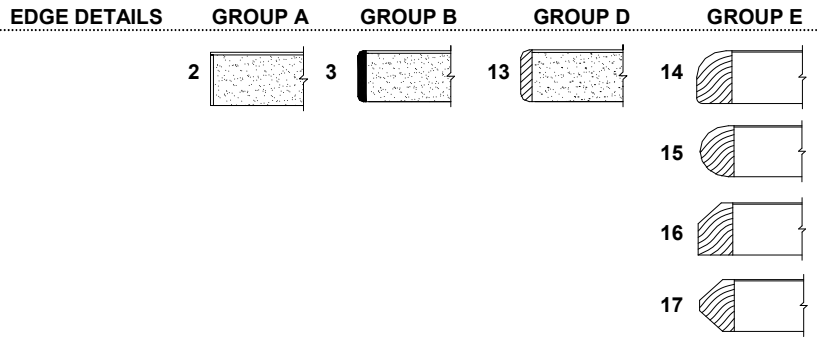

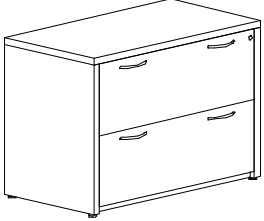
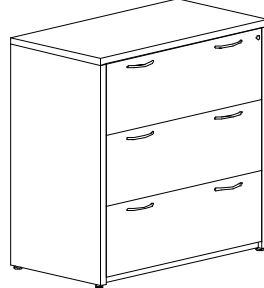
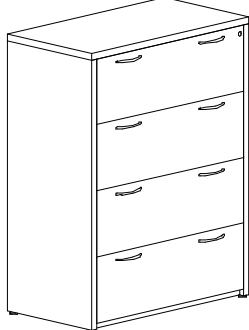
MODEL NUMBER	SIZE D x W x H	WT.	Drawers	GROUP A	GROUP B	GROUP D	GROUP E	
				Self Edge all edges	3mm pvc top and end panels	1/8" E.W.E. perimeter of top only; bal. of edges self edge	Wood edge on front and ends of top only; bal. of edges self edge	
	453-2031-□	20 x 31 x 29	165	2	1639	1673	1915	2036
	453-2037-□	20 x 37 x 29	190	2	1742	1783	2076	2220
	453-2043-□	20 x 43 x 29	210	2	1926	1967	2260	2404
	453-2431-□	24 x 31 x 29	182	2	1725	1760	2007	2139
	453-2437-□	24 x 37 x 29	209	2	1829	1869	2179	2340
	453-2443-□	24 x 43 x 29	231	2	2024	2070	2369	2524
	454-2031-□	20 x 31 x 42	231	3	2289	2352	2565	2691
	454-2037-□	20 x 37 x 42	266	3	2438	2490	2777	2921
	454-2043-□	20 x 43 x 42	294	3	2697	2754	3191	3174
	454-2431-□	24 x 31 x 42	254	3	2409	2467	2697	2823
	454-2437-□	24 x 37 x 42	293	3	2565	2616	2910	3065
	454-2443-□	24 x 43 x 42	323	3	2829	2898	3174	3335
	455-2031-□	20 x 31 x 54	297	4	2950	3019	3226	3347
	455-2037-□	20 x 37 x 54	342	4	3140	3203	3467	3617
	455-2043-□	20 x 43 x 54	378	4	3674	3548	3795	3945
	455-2431-□	24 x 31 x 54	327	4	3094	3168	3387	3519
	455-2437-□	24 x 37 x 54	376	4	3289	3364	3651	3801
	455-2443-□	24 x 43 x 54	416	4	3858	3720	3985	4140

OPTIONS:

Arc pulls in polished chrome or satin chrome, no up charge.
Master key, \$30.
Key-change tool, \$30.

NOTES:

Please specify edge detail at the end of the model number.
Standard with key lock.
Standard with interlock device, to prevent multiple drawers from being opened at one time.
Standard with Arc Pulls in black.
Each drawer includes hardware to file: one row of legal size from side-to-side, 30" w & 36" w two rows of letter size from front-to-back, 42" w three rows of letter size from front-to-back,



phone: (510) 259-6217
email: info@actionlaminates.com

LANDMARK SERIES HUTCH UNITS

EDGE DETAILS

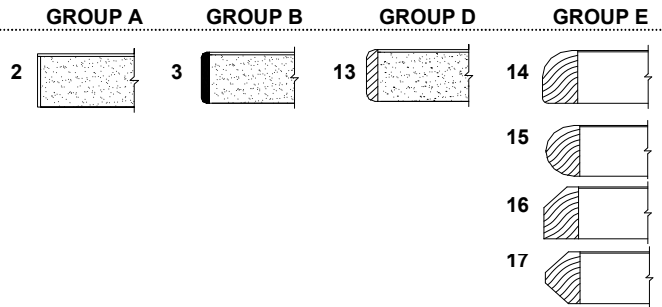

MODEL NUMBER	SIZE D x W x H	WT.	GROUP A Self Edge all edges	GROUP B 3mm pvc all edges	GROUP D 1/8" E.W.E. perimeter of top only; bal. of edges self edge	GROUP E Wood edge on front and ends of top only; bal. of edges self edge
--------------	-------------------	-----	-----------------------------------	---------------------------------	--	--

SINGLE

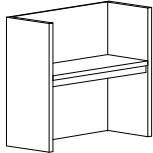

OPEN, NO TOP

447-1530-□	15 x 30 x 36	74	863	949	-	-
447-1536-□	15 x 36 x 36	81	886	978	-	-
447-1542-□	15 x 42 x 36	89	983	1081	-	-

DOUBLE

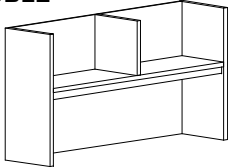

447-1548-□	15 x 48 x 36	96	1047	1150	-	-
447-1560-□	15 x 60 x 36	111	1162	1282	-	-
447-1572-□	15 x 72 x 36	126	1288	1415	-	-

TRIPLE

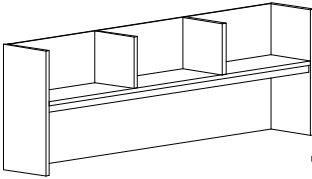

447-1584-□	15 x 84 x 36	141	1673	1840	-	-
447-1596-□	15 x 96 x 36	156	1673	1840	-	-

SINGLE

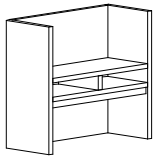

OPEN, NO TOP, WITH ORGANIZER

448-1530-□	15 x 30 x 36	98	1070	1173	-	-
448-1536-□	15 x 36 x 36	108	1133	1242	-	-
448-1542-□	15 x 42 x 36	119	1248	1374	-	-

DOUBLE

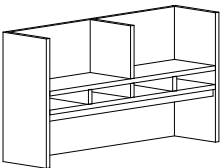

448-1548-□	15 x 48 x 36	156	1386	1518	-	-
448-1560-□	15 x 60 x 36	177	1570	1725	-	-
448-1572-□	15 x 72 x 36	198	1737	1915	-	-

TRIPLE

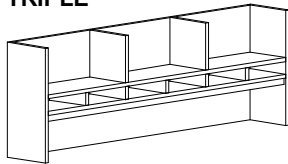

448-1584-□	15 x 84 x 36	237	2254	2478	-	-
448-1596-□	15 x 96 x 36	258	2254	2478	-	-

OPTIONS:

Task light not included; see accessories page 171.
Add 10% for unit 37" to 48" high.

NOTES:

1-1/4" thick construction.
Please specify edge detail at the end of the model number.
Standard with fully enclosed, finished back.
Standard with 3" round grommet in back panel.
Standard with task light fascia.
Standard with attaching hardware.
Organizer has 4" height clearance.



phone: (510) 259-6217
email: info@actionlaminates.com

LANDMARK SERIES HUTCH UNITS

EDGE DETAILS

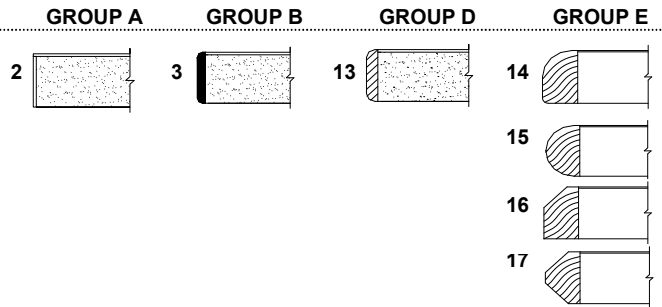

MODEL NUMBER	SIZE D x W x H	WT.	GROUP A Self Edge all edges	GROUP B 3mm pvc all edges	GROUP D 1/8" E.W.E. perimeter of top only; bal. of edges self edge	GROUP E Wood edge on front and ends of top only; bal. of edges self edge
--------------	-------------------	-----	-----------------------------------	---------------------------------	--	--

SINGLE

OPEN, WITH TOP

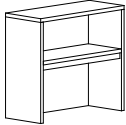

449-1530-□	15 x 30 x 36	89	955	1052	1167	1265
449-1536-□	15 x 36 x 36	99	1006	1104	1248	1351
449-1542-□	15 x 42 x 36	110	1127	1231	1392	1507

DOUBLE

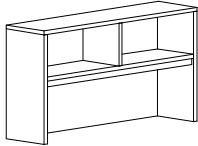

449-1548-□	15 x 48 x 36	120	1202	1317	1495	1622
449-1560-□	15 x 60 x 36	141	1351	1495	1708	1863
449-1572-□	15 x 72 x 36	162	1512	1662	1926	2105

TRIPLE

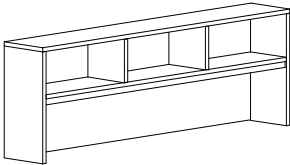

449-1584-□	15 x 84 x 36	183	1984	2179	2496	2731
449-1596-□	15 x 96 x 36	204	1984	2179	2496	2731

SINGLE

OPEN, WITH TOP, WITH ORGANIZER



450-1530-□	15 x 30 x 36	113	1162	1282	1380	1472
450-1536-□	15 x 36 x 36	126	1242	1369	1484	1593
450-1542-□	15 x 42 x 36	140	1386	1518	1656	1771

DOUBLE

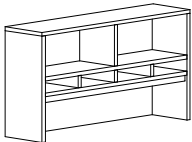

450-1548-□	15 x 48 x 36	180	1547	1702	1840	1967
450-1560-□	15 x 60 x 36	207	1760	1938	2116	2271
450-1572-□	15 x 72 x 36	234	1961	2162	2375	2559

TRIPLE

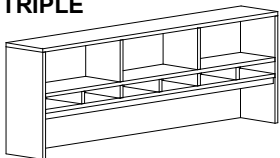

450-1584-□	15 x 84 x 36	279	2565	2818	3076	3318
450-1596-□	15 x 96 x 36	306	2565	2818	3076	3318

OPTIONS:

Task light not included; see accessories page 171.
Add 10% for unit 37" to 48" high.

NOTES:

1-1/4" thick construction.
Please specify edge detail at the end of the model number.
Standard with fully enclosed, finished back.
Standard with 3" round grommet in back panel.
Standard with task light fascia.
Standard with attaching hardware.
Organizer has 4" height clearance.



phone: (510) 259-6217
email: info@actionlaminates.com

LANDMARK SERIES HUTCH UNITS

EDGE DETAILS

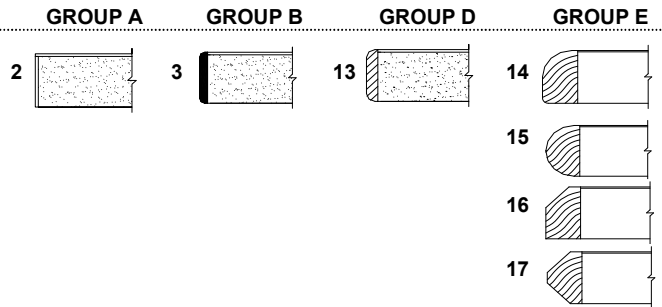

MODEL NUMBER	SIZE D x W x H	WT.	GROUP A Self Edge all edges	GROUP B 3mm pvc all edges	GROUP D 1/8" E.W.E. perimeter of top only; bal. of edges self edge	GROUP E Wood edge on front and ends of top only; bal. of edges self edge
--------------	-------------------	-----	-----------------------------------	---------------------------------	--	--

SINGLE

HINGED DOORS

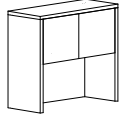

451-1530-□	15 x 30 x 36	100	1107	1211	1326	1418
451-1536-□	15 x 36 x 36	113	1189	1299	1431	1534
451-1542-□	15 x 42 x 36	125	1335	1461	1599	1714

DOUBLE

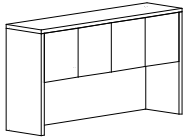

451-1548-□	15 x 48 x 36	138	1446	1578	1739	1877
451-1560-□	15 x 60 x 36	164	1662	1817	2013	2168
451-1572-□	15 x 72 x 36	189	1873	2051	2287	2465

TRIPLE

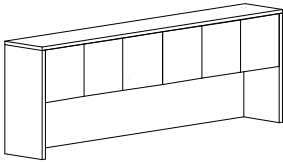

451-1584-□	15 x 84 x 36	215	2457	2687	2969	3204
451-1596-□	15 x 96 x 36	240	2472	2702	2984	3219

SINGLE

HINGED DOORS, WITH ORGANIZER

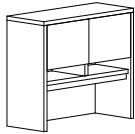

452-1530-□	15 x 30 x 36	124	1320	1446	1533	1625
452-1536-□	15 x 36 x 36	140	1425	1557	1661	1776
452-1542-□	15 x 42 x 36	155	1599	1755	1870	1985

DOUBLE

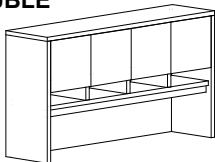

452-1548-□	15 x 48 x 36	198	1791	1969	2090	2222
452-1560-□	15 x 60 x 36	230	2099	2300	2450	2605
452-1572-□	15 x 72 x 36	261	2292	2517	2701	2885

TRIPLE

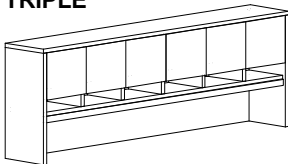

452-1584-□	15 x 84 x 36	311	3032	3331	3555	3785
452-1596-□	15 x 96 x 36	342	3047	3346	3570	3800

OPTIONS:

- Task light not included; see accessories page 171.
- Add 10% for unit 37" to 48" high.
- Lock for pair of doors, add \$ 70 list.
- Master Key, \$30 list.
- Key-change tool, \$30 list.

NOTES:

- 1-1/4" thick construction.
- Please specify edge detail at the end of the model number.
- Standard with fully enclosed, finished back.
- Standard with 3" round grommet in back panel.
- Standard with task light fascia.
- Standard with attaching hardware.
- Organizer has 4" height clearance.



phone: (510) 259-6217
email: info@actionlaminates.com

LANDMARK SERIES BOOKCASE/HUTCH UNITS

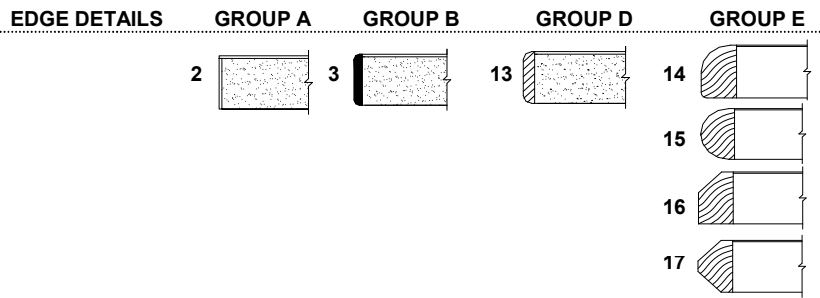

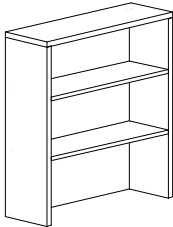
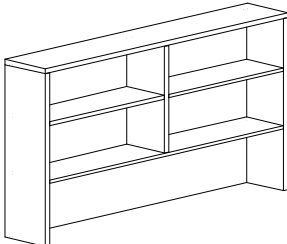
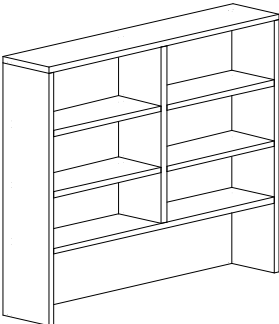
	MODEL NUMBER	SIZE D x W x H	WT.	Number of adj. shelves	GROUP A Self Edge all edges	GROUP B 3mm pvc all edges	GROUP D 1/8" E.W.E. perimeter of top only; bal. of edges self edge	GROUP E Wood edge on front and ends of top only; bal. of edges self edge		
SINGLE 	Single									
	456-3043-□	12 x 30 x 43	93	2	828	914	1029	1110		
	456-3643-□	12 x 36 x 43	105	2	949	1047	1167	1265		
	456-4243-□	12 x 42 x 43	133	2	1139	1248	1386	1501		
	456-4843-□	12 x 48 x 43	145	2	1179	1300	1466	1587		
	Double									
	456-6043-□	12 x 60 x 43	170	2	1380	1512	1708	1857		
	456-7243-□	12 x 72 x 43	194	2	1581	1737	1967	2139		
DOUBLE 	Single									
	456-3055-□	12 x 30 x 55	121	3	1041	1144	1231	1317		
	456-3655-□	12 x 36 x 55	137	3	1179	1300	1403	1501		
	456-4255-□	12 x 42 x 55	173	3	1455	1599	1702	1823		
	456-4855-□	12 x 48 x 55	189	3	1507	1662	1788	1915		
	Double									
	456-6055-□	12 x 60 x 55	221	4	1760	1938	2093	2248		
	456-7255-□	12 x 72 x 55	252	4	2024	2225	2421	2582		
		Single								
		457-3043-□	15 x 30 x 43	109	2	1018	1127	1213	1300	
		457-3643-□	15 x 36 x 43	123	2	1156	1271	1380	1478	
		457-4243-□	15 x 42 x 43	157	2	1380	1512	1622	1742	
457-4843-□		15 x 48 x 43	171	2	1426	1576	1708	1834		
Double										
457-6043-□		15 x 60 x 43	199	2	1662	1834	1995	2145		
457-7243-□		15 x 72 x 43	226	2	1898	2082	2283	2455		
Single										
457-3055-□		15 x 30 x 55	142	3	1271	1403	1472	1553		
457-3655-□		15 x 36 x 55	160	3	1438	1587	1662	1760		
457-4255-□		15 x 42 x 55	204	3	1783	1955	2030	2145		
457-4855-□	15 x 48 x 55	222	3	1834	2018	2116	2237			
Double										
457-6055-□	15 x 60 x 55	259	4	2133	2352	2467	2616			
457-7255-□	15 x 72 x 55	295	4	2432	2674	2823	2996			

OPTIONS:

NOTES:

Please specify edge detail at end of model number.
1-1/4" thick construction; 7/8" thick back, finished back.
Double unit with fixed bottom shelf.
Standard with attachment hardware.
60"w - 72"w include fixed height shelf at bottom
with 18" height clearance below shelf.



phone: (510) 259-6217
email: info@actionlaminates.com

EDGE DETAILS

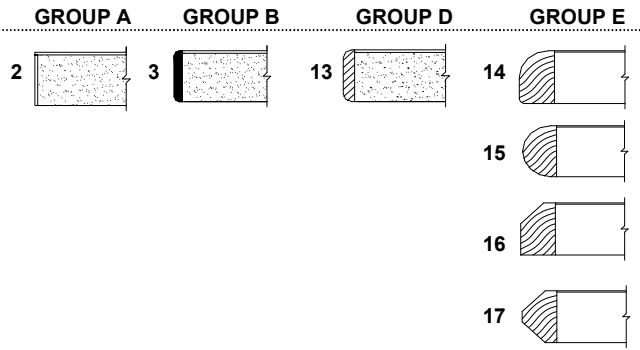

**LANDMARK SERIES
OPEN BOOKCASES, 12" DEEP**

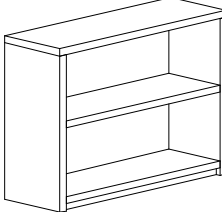
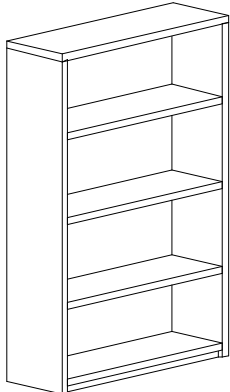
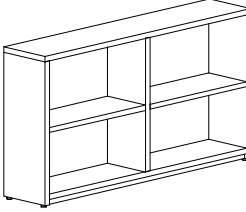
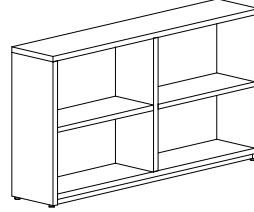
MODEL NUMBER	SIZE D x W x H	WT.	Number of adj. shelves	GROUP A	GROUP B	GROUP D	GROUP E
				Self Edge all edges	3mm pvc all edges	1/8" E.W.E. perimeter of top only; bal. of edges self edge	Wood edge on front and ends of top only; bal. of edges self edge
 442-3029- □	12 x 30 x 29	75	1	564	615	759	845
442-3036- □	12 x 30 x 36	83	1	627	684	817	909
442-3048- □	12 x 30 x 48	111	2	828	909	1024	1116
442-3060- □	12 x 30 x 60	139	3	1041	1144	1231	1317
442-3072- □	12 x 30 x 72	167	4	1248	1374	1438	1524
442-3084- □	12 x 30 x 84	194	5	1461	1599	1650	1737
442-3096- □	12 x 30 x 96	222	6	1662	1829	1857	1944
Extra Shelf, 12"d X 30"w, Self Edge: \$75							
 442-3629- □	12 x 36 x 29	86	1	638	707	863	960
442-3636- □	12 x 36 x 36	95	1	713	782	937	1029
442-3648- □	12 x 36 x 48	126	2	949	1047	1167	1265
442-3660- □	12 x 36 x 60	158	3	1179	1305	1409	1507
442-3672- □	12 x 36 x 72	189	4	1420	1564	1645	1742
442-3684- □	12 x 36 x 84	221	5	1662	1823	1875	1972
442-3696- □	12 x 36 x 96	252	6	1898	2082	2116	2214
Extra Shelf, 12"d x 36"w, Self Edge: \$92							
 442-4829- □	12 x 48 x 29	107	1	799	880	1075	1202
442-4836- □	12 x 48 x 36	117	1	880	972	1162	1288
442-4848- □	12 x 48 x 48	156	2	1179	1300	1455	1581
442-4860- □	12 x 48 x 60	195	3	1478	1616	1748	1869
442-4872- □	12 x 48 x 72	234	4	1771	1944	2047	2174
442-4884- □	12 x 48 x 84	273	5	2059	2271	2340	2467
442-4896- □	12 x 48 x 96	312	6	2358	2588	2634	2754
Extra Shelf, 12"d x 48"w, Self Edge: \$127							
 442-6029- □	12 x 60 x 29	136	2	1024	1121	1351	1501
442-7229- □	12 x 72 x 29	157	2	1179	1300	1570	1742
442-6036- □	12 x 60 x 36	153	2	1156	1265	1489	1639
442-7236- □	12 x 72 x 36	176	2	1328	1466	1719	1898
442-6048- □	12 x 60 x 48	204	4	1541	1691	1869	2024
442-7248- □	12 x 72 x 48	234	4	1771	1944	2162	2335

OPTIONS:

Lock for laminate hinged doors, add \$70. List price. (Note: when lock is specified, adjustable shelf at 29" high will be changed to fixed height.)

NOTES:

1-1/4" thick construction; 7/8" thick back.
Finished back.
Counter height (42" high) available for same price as 48" high.



phone: (510) 259-6217
email: info@actionlaminates.com

EDGE DETAILS

GROUP A

GROUP B

GROUP D

GROUP E

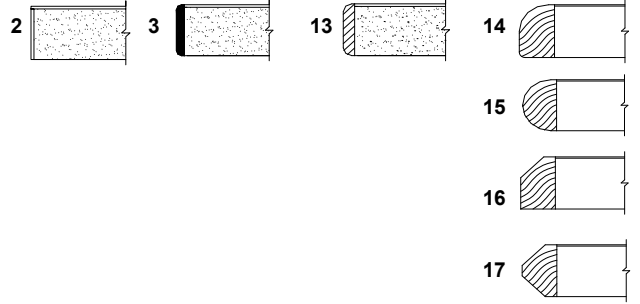

**LANDMARK SERIES
OPEN BOOKCASES, 15" DEEP**

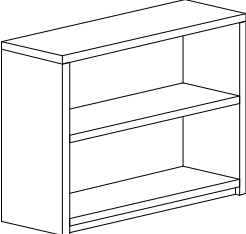
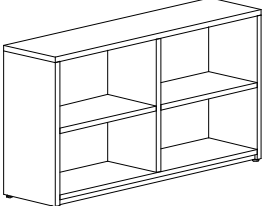
MODEL NUMBER	SIZE D x W x H	WT.	Number of adj. shelves	GROUP A	GROUP B	GROUP D	GROUP E
				Self Edge all edges	3mm pvc all edges	1/8" E.W.E. perimeter of top only; bal. of edges self edge	Wood edge on front and ends of top only; bal. of edges self edge
 443-3029- □	15 x 30 x 29	94	1	690	759	909	995
443-3036- □	15 x 30 x 36	104	1	765	845	978	1075
443-3048- □	15 x 30 x 48	138	2	1024	1127	1231	1328
443-3060- □	15 x 30 x 60	173	3	1271	1403	1489	1587
443-3072- □	15 x 30 x 72	207	4	1530	1685	1742	1840
443-3084- □	15 x 30 x 84	242	5	1788	1967	1995	2093
443-3096- □	15 x 30 x 96	276	6	2041	2248	2260	2352
Extra Shelf, 15"d X 30"w, Self Edge: \$98							
443-3629- □	15 x 36 x 29	107	1	788	868	1035	1133
443-3636- □	15 x 36 x 36	117	1	868	955	1110	1213
443-3648- □	15 x 36 x 48	156	2	1156	1271	1397	1507
443-3660- □	15 x 36 x 60	195	3	1438	1593	1691	1794
443-3672- □	15 x 36 x 72	234	4	1737	1915	1972	2082
443-3684- □	15 x 36 x 84	273	5	2024	2225	2266	2375
443-3696- □	15 x 36 x 96	312	6	2312	2547	2559	2657
Extra Shelf, 15"d x 36"w, Self Edge: \$127							
443-4829- □	15 x 48 x 29	132	1	978	1075	1282	1409
443-4836- □	15 x 48 x 36	144	1	1070	1179	1374	1501
443-4848- □	15 x 48 x 48	192	2	1426	1570	1731	1857
443-4860- □	15 x 48 x 60	240	3	1783	1961	2087	2214
443-4872- □	15 x 48 x 72	288	4	2145	2363	2450	2576
443-4884- □	15 x 48 x 84	336	5	2501	2754	2800	2933
443-4896- □	15 x 48 x 96	384	6	2869	3145	3157	3283
Extra Shelf, 15"d x 48"w, Self Edge: \$155							
 443-6029- □	15 x 60 x 29	173	2	1271	1403	1633	1783
443-7229- □	15 x 72 x 29	198	2	1472	1610	1875	2053
443-6036- □	15 x 60 x 36	189	2	1403	1547	1754	1915
443-7236- □	15 x 72 x 36	216	2	1610	1765	2018	2197
443-6048- □	15 x 60 x 48	252	4	1869	2059	2220	2381
443-7248- □	15 x 72 x 48	288	4	2145	2363	2559	2731

OPTIONS:

Lock for laminate hinged doors, add \$70. List price. (Note: when lock is specified, adjustable shelf at 29" high will be changed to fixed height.)

NOTES:

1-1/4" thick construction; 7/8" thick back.
Finished back.

Counter height (42" high) available for same price as 48" high.



phone: (510) 259-6217
 email: info@actionlaminates.com

EDGE DETAILS

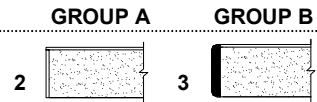

LANDMARK SERIES
INSET HINGED DOORS

Laminate Doors	SIZE PER PAIR		Hinges per		GROUP A	GROUP B
	W x H	WT.	door			
	447-3029- □	27-1/2 x 27	17	2	184	207
	447-3036- □	27-1/2 x 34	21	2	213	242
	447-3048- □	27-1/2 x 46	29	3	282	322
	447-3060- □	27-1/2 x 58	36	3	351	403
	447-3072- □	27-1/2 x 70	44	3	420	477
	447-3084- □	27-1/2 x 82	51	4	558	558
	447-3096- □	27-1/2 x 94	59	4	558	638
	447-3629- □	33-1/2 x 27	20	2	213	242
	447-3636- □	33-1/2 x 34	26	2	253	288
	447-3648- □	33-1/2 x 46	35	3	339	385
	447-3660- □	33-1/2 x 58	44	3	420	477
	447-3672- □	33-1/2 x 70	53	3	506	581
	447-3684- □	33-1/2 x 82	62	4	673	673
	447-3696- □	33-1/2 x 94	71	4	673	771
	447-4829- □	45-1/2 x 27	27	2	299	339
	447-4836- □	45-1/2 x 34	34	2	351	403
	447-4848- □	45-1/2 x 46	46	3	460	529
	447-4860- □	45-1/2 x 58	58	3	575	656
	447-4872- □	45-1/2 x 70	70	3	684	782
	447-4884- □	45-1/2 x 82	82	4	776	891
	447-4896- □	45-1/2 x 94	94	4	903	1041

OPTIONS:

Arc pulls in polished chrome or satin chrome, no up charge.
 Double door lock add \$70 list.
 Note: Double door lock requires shelf at 29" high to be fixed height.
 Master key, \$30.
 Key-change tool, \$30.

NOTES:

Standard with Arc Pulls in black.



phone: (510) 259-6217
email: info@actionlaminates.com

LANDMARK SERIES INSET HINGED DOORS

EDGE DETAILS

GROUP A

GROUP B

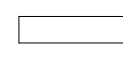

Flat Polish

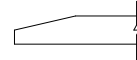

1" Bevel

Glass Doors, no frame	W x H	WT.	Hinges per door		GROUP A	GROUP B
			GROUP A	GROUP B		
SIZE PER PAIR						
	448-3029- □	27-1/2 x 27	18	2	840	882
	448-3036- □	27-1/2 x 34	23	2	894	936
	448-3048- □	27-1/2 x 46	31	3	1152	1206
	448-3060- □	27-1/2 x 58	39	3	1260	1326
	448-3072- □	27-1/2 x 70	47	3	1368	1452
	448-3084- □	27-1/2 x 82	55	4	1620	1710
	448-3096- □	27-1/2 x 94	63	4	1734	1836
	448-3629- □	33-1/2 x 27	22	2	894	936
	448-3636- □	33-1/2 x 34	27	2	960	1008
	448-3648- □	33-1/2 x 46	37	3	1230	1290
	448-3660- □	33-1/2 x 58	46	3	1362	1428
	448-3672- □	33-1/2 x 70	56	3	1482	1566
	448-3684- □	33-1/2 x 82	66	4	1752	1848
	448-3696- □	33-1/2 x 94	75	4	1878	1980
	448-4829- □	45-1/2 x 27	28	2	978	1026
	448-4836- □	45-1/2 x 34	36	2	1056	1110
	448-4848- □	45-1/2 x 46	50	3	1350	1416
	448-4860- □	45-1/2 x 58	62	3	1506	1578
	448-4872- □	45-1/2 x 70	74	3	1656	1740
	448-4884- □	45-1/2 x 82	88	4	1944	2052
	448-4896- □	45-1/2 x 94	100	4	2100	2208

OPTIONS:

Other colors of glass available, please consult factory.

Patterned glass available, please consult factory.

Arc pulls in polished chrome or satin chrome, no up charge.

Double door lock add \$70 list.

Note: Double door lock requires shelf at 29" high to be fixed height.

Master key, \$30.

Key-change tool, \$30.

NOTES:

Standard is 1/4" thick clear, tempered glass.

Standard with Arc Pulls in black.



phone: (510) 259-6217
 email: info@actionlaminates.com

EDGE DETAILS

GROUP A

GROUP B

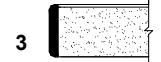
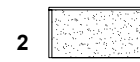

LANDMARK SERIES
INSET HINGED DOORS

		SIZE PER PAIR	Hinges per		GROUP A	GROUP B
		W x H	WT.	door		
Glass Doors, with laminate frame						
		SIZE PER PAIR				
	449-3029- □	27-1/2 x 27	27	2	516	546
	449-3036- □	27-1/2 x 34	34	2	594	624
	449-3048- □	27-1/2 x 46	46	3	744	786
	449-3060- □	27-1/2 x 58	58	3	960	1014
	449-3072- □	27-1/2 x 70	70	3	1092	1152
	449-3084- □	27-1/2 x 82	82	4	1320	1320
	449-3096- □	27-1/2 x 94	94	4	1410	1500
	449-3629- □	33-1/2 x 27	32	2	594	624
	449-3636- □	33-1/2 x 34	41	2	690	726
	449-3648- □	33-1/2 x 46	55	3	876	930
	449-3660- □	33-1/2 x 58	70	3	1104	1170
	449-3672- □	33-1/2 x 70	84	3	1272	1350
	449-3684- □	33-1/2 x 82	98	4	1554	1554
	449-3696- □	33-1/2 x 94	113	4	1662	1776
	449-4829- □	45-1/2 x 27	44	2	762	798
	449-4836- □	45-1/2 x 34	54	2	876	930
	449-4848- □	45-1/2 x 46	74	3	1116	1194
	449-4860- □	45-1/2 x 58	92	3	1434	1530
	449-4872- □	45-1/2 x 70	112	3	1626	1740
	449-4884- □	45-1/2 x 82	132	4	1842	1980
	449-4896- □	45-1/2 x 94	150	4	2124	2274

OPTIONS:

- Other colors of glass available, please consult factory.
- Patterned glass available, please consult factory.
- Arc pulls in polished chrome or satin chrome, no up charge.
- Double door lock add \$70 list.
- Note: Double door lock requires shelf at 29" high to be fixed height.
- Master key, \$30.
- Key-change tool, \$30.

NOTES:

- Standard is 1/4" thick clear, tempered glass.
- Standard with 3" wide laminate frame.
- Standard with Arc Pulls in black.
- Standard 60"h - 96"h is a two panel glass door.
- Please specify edge detail at the end of the model number.



phone: (510) 259-6217
email: info@actionlaminates.com

EDGE DETAILS

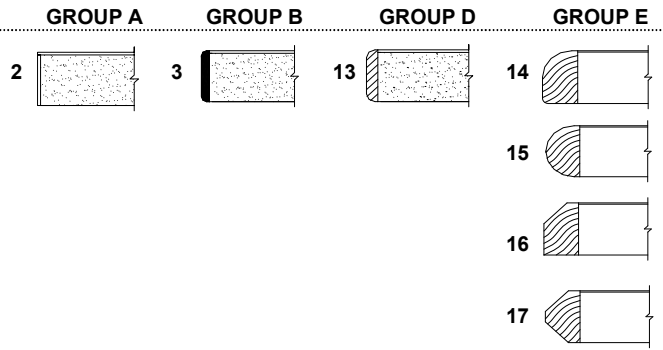

**LANDMARK SERIES
WARDROBE CABINET, 24" DEEP**

MODEL NUMBER	SIZE D x W x H	WT.	GROUP A Self Edge all edges	GROUP B 3mm pvc all edges	GROUP D 1/8" E.W.E. perimeter of top only; bal. of edges self edge	GROUP E Wood edge on front and ends of top only; bal. of edges self edge
446-3072- □	24 x 30 x 72	243	2427	2646	2680	2795
446-3084- □	24 x 30 x 84	269	2705	2952	2958	3067
446-3096- □	24 x 30 x 96	294	2989	3253	3236	3345
446-3672- □	24 x 36 x 72	270	2739	2980	3009	3136
446-3684- □	24 x 36 x 84	297	3039	3315	3321	3447
446-3696- □	24 x 36 x 96	324	3345	3650	3627	3748
446-4872- □	24 x 48 x 72	324	3345	3650	3679	3828
446-4884- □	24 x 48 x 84	354	3713	4046	4046	4196
446-4896- □	24 x 48 x 96	384	4075	4437	4414	4552

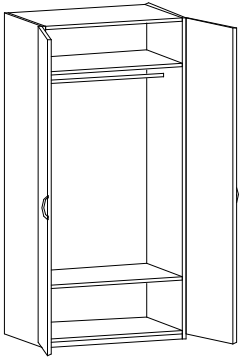

Add effective 10% 7/1/2024

OPTIONS:

NOTES:

1-1/4" thick construction with inset doors.
Standard with one fixed height shelf 12" below top.
Standard with one adjustable shelf at bottom.
Standard with polished chrome clothing rod 3" below fixed height shelf.
Please specify edge detail at the end of the model number.
Standard with finished back.



phone: (510) 259-6217
email: info@actionlaminates.com

EDGE DETAILS

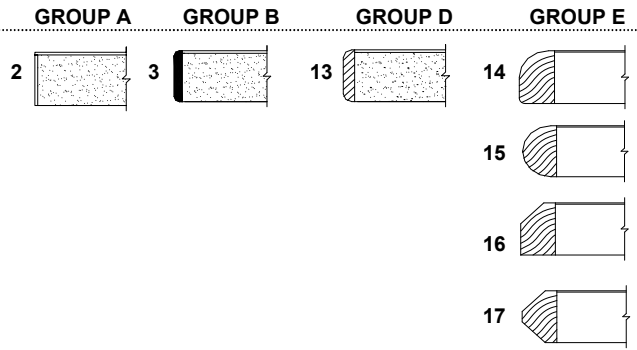

**LANDMARK SERIES
STORAGE CABINET, 18" DEEP**

MODEL NUMBER	SIZE D x W x H	WT.	Number of adj. shelves	GROUP A Self Edge all edges	GROUP B 3mm pvc all edges	GROUP D 1/8" E.W.E. perimeter of top only; bal. of edges self edge	GROUP E Wood edge on front and ends of top only; bal. of edges self edge
--------------	-------------------	-----	------------------------------	-----------------------------------	---------------------------------	--	--

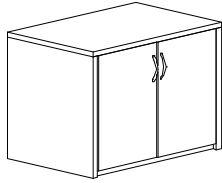

444-3029- □	18 x 30 x 29	103	1	977	1080	1213	1305
444-3036- □	18 x 30 x 36	114	1	1104	1214	1329	1426
444-3048- □	18 x 30 x 48	152	2	1480	1612	1699	1796
444-3060- □	18 x 30 x 60	189	3	1850	2011	2069	2166
444-3072- □	18 x 30 x 72	210	3	2088	2283	2312	2416
444-3084- □	18 x 30 x 84	248	4	2458	2688	2676	2780
444-3096- □	18 x 30 x 96	269	4	2696	2954	2926	3023

Extra Shelf, 18"d X 30"w, Self Edge: \$138

Extra Shelf, 18"d X 30"w, 3mm pvc edgebanding: \$150

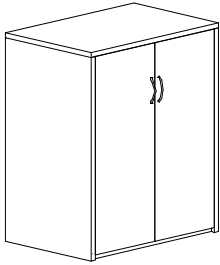

444-3629- □	18 x 36 x 29	117	1	1133	1237	1380	1495
444-3636- □	18 x 36 x 36	128	1	1269	1390	1516	1631
444-3648- □	18 x 36 x 48	171	2	1690	1851	1943	2052
444-3660- □	18 x 36 x 60	214	3	2111	2312	2364	2473
444-3672- □	18 x 36 x 72	236	3	2382	2607	2641	2750
444-3684- □	18 x 36 x 84	279	4	2809	3062	3056	3177
444-3696- □	18 x 36 x 96	302	4	3081	3368	3328	3437

Extra Shelf, 18"d x 36"w, Self Edge: \$155

Extra Shelf, 18"d x 36"w, 3mm pvc edgebanding: \$167

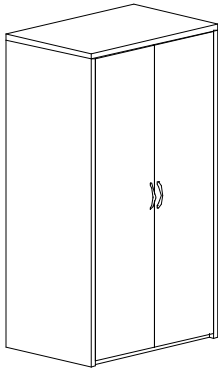

444-4829- □	18 x 48 x 29	145	1	1423	1566	1733	1865
444-4836- □	18 x 48 x 36	158	1	1592	1736	1891	2035
444-4848- □	18 x 48 x 48	210	2	2121	2322	2431	2558
444-4860- □	18 x 48 x 60	263	3	2655	2897	2954	3098
444-4872- □	18 x 48 x 72	288	3	2977	3253	3288	3420
444-4884- □	18 x 48 x 84	341	4	3512	3834	3816	3954
444-4896- □	18 x 48 x 96	366	4	3839	4196	4150	4288

Extra Shelf, 18"d x 48"w, Self Edge: \$2010

Extra Shelf, 18"d x 48"w, 3mm pvc edgebanding: \$219

OPTIONS:

Lock for pair of hinged doors, add \$70. List price. (Note: when lock is specified, adjustable shelf at 29" high will be changed to fixed height.)

NOTES:

1-1/4" thick construction; 7/8" thick back.
Finished back.



phone: (510) 259-6217
email: info@actionlaminates.com

EDGE DETAILS

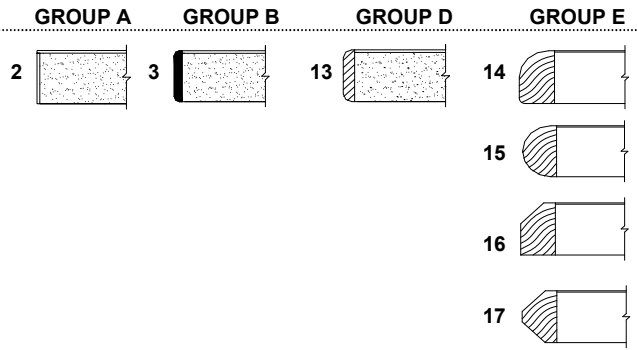

**LANDMARK SERIES
STORAGE CABINET, 24" DEEP**

MODEL NUMBER	SIZE D x W x H	WT.	Number of adj. shelves	GROUP A Self Edge all edges	GROUP B 3mm pvc all edges	GROUP D 1/8" E.W.E. perimeter of top only; bal. of edges self edge	GROUP E Wood edge on front and ends of top only; bal. of edges self edge
--------------	-------------------	-----	------------------------------	-----------------------------------	---------------------------------	--	--

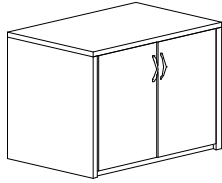

445-3029- □	24 x 30 x 29	131	1	1195	1310	1448	1558
445-3036- □	24 x 30 x 36	144	1	1334	1461	1582	1691
445-3048- □	24 x 30 x 48	192	2	1779	1946	2026	2136
445-3060- □	24 x 30 x 60	240	3	2218	2425	2477	2586
445-3072- □	24 x 30 x 72	266	3	2502	2732	2749	2858
445-3084- □	24 x 30 x 84	314	4	2947	3217	3188	3309
445-3096- □	24 x 30 x 96	339	4	3219	3524	3466	3581

Extra Shelf, 24"d X 30"w, Self Edge: \$173
Extra Shelf, 24"d X 30"w, 3mm pvc edgebanding: \$190

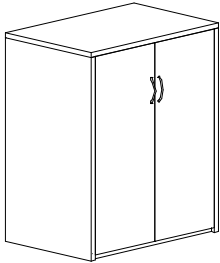

445-3629- □	24 x 36 x 48	149	1	1369	1495	1645	1766
445-3636- □	24 x 36 x 48	162	1	1516	1660	1798	1924
445-3648- □	24 x 36 x 48	216	2	2023	2213	2305	2426
445-3660- □	24 x 36 x 60	270	3	2531	2766	3203	2939
445-3672- □	24 x 36 x 72	297	3	2831	3101	3113	3239
445-3684- □	24 x 36 x 84	351	4	3344	3654	3620	3746
445-3696- □	24 x 36 x 96	378	4	3644	3995	3926	4047

Extra Shelf, 24"d x 36"w, Self Edge: \$196
Extra Shelf, 24"d x 36"w, 3mm pvc edgebanding: \$213

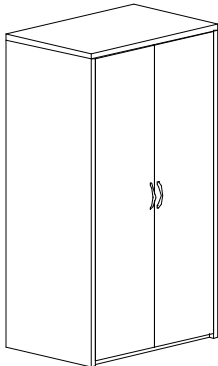

445-4829- □	24 x 48 x 29	183	1	1710	1865	2044	2193
445-4836- □	24 x 48 x 36	198	1	1885	2069	2225	2374
445-4848- □	24 x 48 x 48	264	2	2523	2759	2857	3001
445-4860- □	24 x 48 x 60	330	3	3150	3449	3483	3633
445-4872- □	24 x 48 x 72	360	3	3512	3845	3845	4001
445-4884- □	24 x 48 x 84	426	4	4150	4535	4483	4627
445-4896- □	24 x 48 x 96	456	4	4512	4920	4840	4989

Extra Shelf, 24"d x 48"w, Self Edge: \$270
Extra Shelf, 24"d x 48"w, 3mm pvc edgebanding: \$293

OPTIONS:

Lock for pair of hinged doors, add \$70. List price. (Note: when lock is specified, adjustable shelf at 29" high will be changed to fixed height.)

NOTES:

1-1/4" thick construction; 7/8" thick back.
Finished back.



phone: (510) 259-6217
email: info@actionlaminates.com

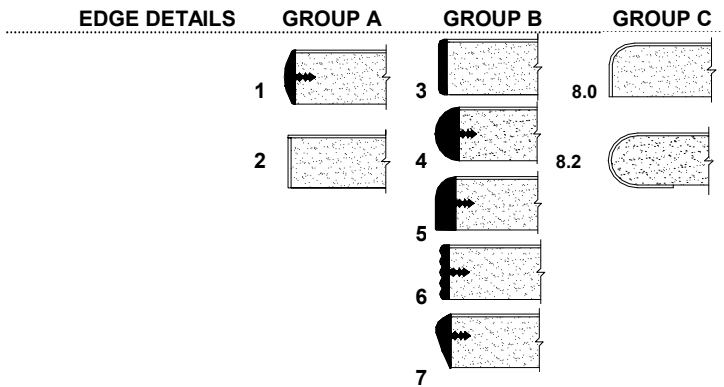

LANDMARK SERIES STUDY CARREL, 48" HIGH

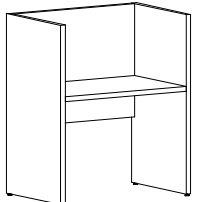
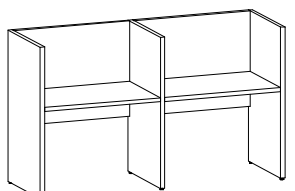
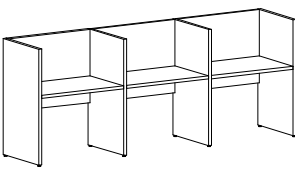
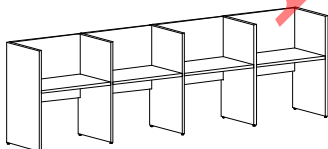
	MODEL NUMBER	SIZE	WT.	GROUP A	GROUP B	GROUP C
SINGLE STATION						
		D x W x H				
	458-1-2436- □	24 x 36 x 48	148	989	1087	1064
	458-1-2448- □	24 x 48 x 48	170	1087	1196	1167
	458-1-3036- □	30 x 36 x 48	175	1150	1265	1242
	458-1-3048- □	30 x 48 x 48	200	1254	1380	1357
DOUBLE STATION						
	458-2-2472- □	24 x 72 x 48	215	1737	1903	1886
	458-2-2496- □	24 x 96 x 48	260	1932	2116	2099
	458-2-3072- □	30 x 72 x 48	250	1995	2191	2179
	458-2-3096- □	30 x 96 x 48	300	2202	2421	2409
TRIPLE STATION						
	458-3-24108- □	24 x 108 x 48	283	2478	2720	2708
	458-3-24144- □	24 x 144 x 48	350	2772	3042	3019
	458-3-30108- □	30 x 108 x 48	325	2829	3111	3111
	458-3-30144- □	30 x 144 x 48	400	3145	3456	3456
QUADRUPLE STATION						
	458-4-24144- □	24 x 144 x 48	350	3226	3536	3525
	458-4-24192- □	24 x 192 x 48	440	3611	3962	3950
	458-4-30144- □	30 x 144 x 48	400	3680	4042	4048
	458-4-30192- □	30 x 192 x 48	500	4094	4497	4508

OPTIONS:

Round Grommet 3" add \$ 30 List.
For end panels with arched top, add \$75. List per panel.
For custom dimensions, please consult factory.
Many power and data devices available, please consult factory.

NOTES:

Please specify edge detail at the end of the model number.
Group 3 edges are on Worksurfaces only
1-1/4" thick construction.
Standard with 30" high back panel, positioned with
18" height clearance below.



phone: (510) 259-6217
email: info@actionlaminates.com

EDGE DETAILS

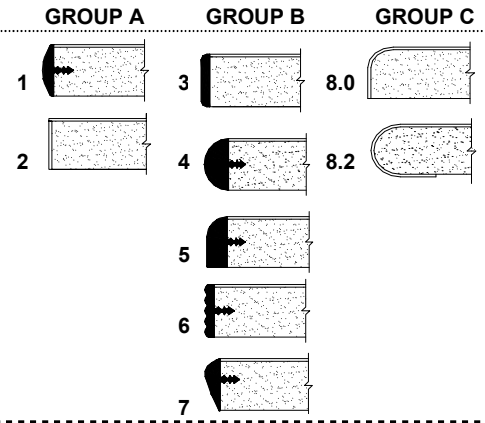

**LANDMARK SERIES
STUDY CARREL, 60" HIGH**

	MODEL NUMBER	SIZE	WT.	GROUP A	GROUP B	GROUP C
SINGLE STATION						
		D x W x H				
	459-1-2436- □	24 x 36 x 60	183	1248	1374	1328
	459-1-2448- □	24 x 48 x 60	210	1392	1524	1478
	459-1-3036- □	30 x 36 x 60	208	1443	1587	1541
	459-1-3048- □	30 x 48 x 60	245	1593	1748	1696
DOUBLE STATION						
	459-2-2472- □	24 x 72 x 60	265	2185	2398	2340
	459-2-2496- □	24 x 96 x 60	320	2461	2708	2634
	459-2-3072- □	30 x 72 x 60	305	2490	2743	2685
	459-2-3096- □	30 x 96 x 60	365	2789	3065	2996
TRIPLE STATION						
	459-3-24108- □	24 x 108 x 60	348	3117	3427	3347
	459-3-24144- □	24 x 144 x 60	430	3536	3887	3789
	459-3-30108- □	30 x 108 x 60	395	3542	3899	3830
	459-3-30144- □	30 x 144 x 60	485	3979	4382	4295
QUADRUPLE STATION						
	459-4-24144- □	24 x 144 x 60	430	4054	4456	4364
	459-4-24192- □	24 x 192 x 60	540	4617	5066	4945
	459-4-30144- □	30 x 144 x 60	485	4594	5049	4974
	459-4-30192- □	30 x 192 x 60	605	5175	5698	5595

OPTIONS:

Round Grommet 3" add \$ 30 List.
For end panels with arched top , add \$75. List per panel.
For custom dimensions, please consult factory.
Many power and data devices available, please consult factory.



NOTES:

Please specify edge detail at the end of the model number.
Group 3 edges are on Worksurfaces only
1-1/4" thick construction.
Standard with 42" high back panel, positioned with
18" height clearance below.

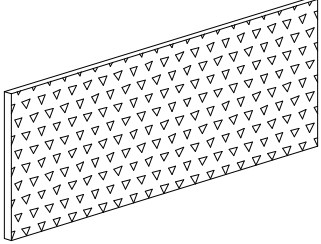
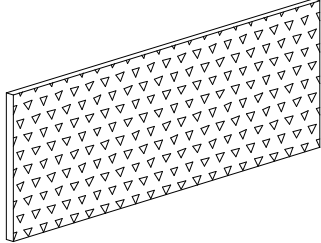
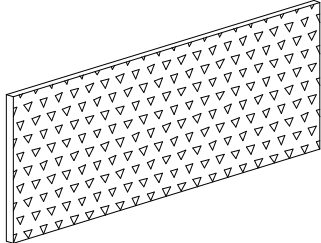
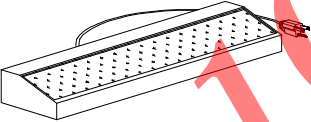

phone: (510) 259-6217
email: info@actionlaminates.com

LANDMARK SERIES ACCESSORIES

	MODEL NUMBER	SIZE	WT.	GROUP A	C.O.M. Yardage
HUTCH-MOUNT FABRIC TACK BOARDS					
		H x W x THICKNESS			
	TB-HM-1236	12 x 33.5 x .5	7	259	1.25
	TB-HM-1248	12 x 45.5 x .5	10	288	1.50
	TB-HM-1260	12 x 57.5 x .5	14	345	2.00
	TB-HM-1272	12 x 69.5 x .5	18	397	2.25
	TB-HM-1284	12 x 81.5 x .5	21	449	2.50
	TB-HM-1296	12 x 93.5 x .5	24	472	3.00
HUTCH-MOUNT FABRIC TACK BOARDS					
	TB-HM-1836	18 x 33.5 x .5	7	282	1.25
	TB-HM-1848	18 x 45.5 x .5	10	311	1.50
	TB-HM-1860	18 x 57.5 x .5	14	374	2.00
	TB-HM-1872	18 x 69.5 x .5	18	426	2.25
	TB-HM-1884	18 x 81.5 x .5	21	483	2.50
	TB-HM-1896	18 x 93.5 x .5	24	512	3.00
HUTCH-MOUNT FABRIC TACK BOARDS					
	TB-HM-2436	24 x 33.5 x .5	7	305	1.25
	TB-HM-2448	24 x 45.5 x .5	10	339	1.50
	TB-HM-2460	24 x 57.5 x .5	14	403	2.00
	TB-HM-2472	24 x 69.5 x .5	18	472	2.25
	TB-HM-2484	24 x 81.5 x .5	21	523	2.50
	TB-HM-2496	24 x 93.5 x .5	24	569	3.00
FLUORESCENT TASK LIGHTS*					
	TL-F-18-BK	18"w Fits 24" shelf	5	125	*Available while Supplies last.
	TL-F-24-BK	24"w Fits 30-36" shelf	7	135	To be replaced by same unit with LED bulb.
	TL-F-36-BK	36"w Fits 42-48" shelf	9	160	
	TL-F-48-BK	48"w Fits 60" shelf	11	180	
	TL-F-60-BK	60"w Fits 72" shelf	13	265	
LED TASK LIGHT					
	TL-LED-7W-18	18"w Fits 24" shelf	6	196	
	TL-LED-13W-24	24"w Fits 30-36" shelf	7	224	
	TL-LED-17W-36	36"w Fits 42-48" shelf	10	299	
	TL-LED-20W-48	48"w Fits 60" shelf	13	368	
	TL-LED-21W-60	60"w Fits 72" shelf	16	454	

OPTIONS:

LED Task light case is solid aluminum alloy
LED Task lights can be daisy-chained together
Please specify LED light color from Kelvin scale
3000K Warm White = WW, or 5200K Cool White = CW.





NOTES:

Standard fabric is Guilford of Maine "Crosstown", "Mingle", "Anchorage" & "FR701". Please specify the color.
Tack Boards are attached to hutch back panel with pin nails.
Fluorescent Task light case finish is black.
LED Task light is Daisy-chain compatible includes a 12" Daisey-chain cable.

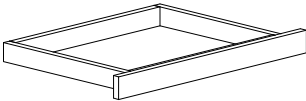
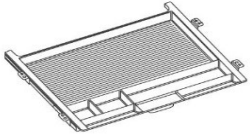
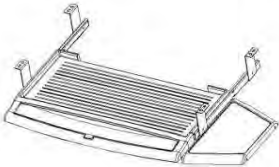

phone: (510) 259-6217
email: info@actionlaminates.com

LANDMARK SERIES ACCESSORIES

	MODEL NUMBER	SIZE D x W x H	WT.	FINISH	LIST PRICE
PENCIL DRAWER, LAMINATE FRONT					
	PD-24	16 x 24 x 3	15	Standard matte finish laminate front	185
PLASTIC PENCIL DRAWER					
	PPD-21	19 x 21 x 2	5	Black plastic	88
PLASTIC KEYBOARD TRAY					
	PKT-26	18-1/4 X 21/26-1/4 X 2	5	Black plastic	95
HORIZONTAL WIRE MANAGER					
	WM-2-□	1-1/4" x 2-1/2"		Black plastic	\$12 per lineal ft.
VERTICAL WIRE MANAGER					
	VWM-1-□	2 X 22		Black plastic Silver plastic	33 33
ONE-PIECE VERTICAL WIRE MANAGER					
	WM-1-□	1-3/4" X 15/16"		Black plastic Silver plastic	\$12 per lineal ft.



phone: (510) 259-6217
 email: info@actionlaminates.com

LANDMARK SERIES ACCESSORIES - DOOR / DRAWER PULLS

	MODEL NUMBER	SIZE	WT.	FINISH	LIST PRICE	
	PULL-1	5" C-to-C		Black, Polished Chrome, Satin Chrome, Nickel Matte	8	All
	PULL-2	5" C-to-C		Brushed Stainless Steel Black Matte	8	S.S. B
	PULL-3	5" C-to-C		Matt Chrome, Matt Nickel	18	All
	PULL-4	5" C-to-C		Brushed Nickel	13	B. N.
	PULL-5	4" C-to-C		Silver Anodized, Bronze, Matte Silver, Satin Chrome, Polished Black, Polished Chrome	38	All
	PULL-6	2" C-to-C		Black, Polished Chrome, Satin Chrome	23	All
	PULL-7	5" C-to-C		Matt Stainless Steel	30	Matt S.S
	PULL-8	5" C-to-C		Stainless Steel	13	All
	PULL-9	2-1/2" C-to-C		Black, Polished Chrome, Stainless Steel	24 35 35	Black Chrome S.S.
	PULL -10	5" C-to-C		Polished Chrome Stainless Steel	14 12	Chrome S.S.

OPTIONS:

Many other pull styles are available, please consult factory.

NOTES:



phone: (510) 259-6217
 email: info@actionlaminates.com

LANDMARK SERIES ACCESSORIES - GROMMETS

	MODEL NUMBER	SIZE	FINISH	LIST PRICE
	GR-1-BK	3/4" hole	Black	26
	GR-3-BK	2-1/2" hole	Black	30
	GR-4-BK	4" hole	Black	45
	GR-3-SC GR-3-PC GR-3-PB	2-1/2" hole 2-1/2" hole 2-1/2" hole	Satin Chrome Polished Chrome Polished Brass (Plastic plated grommets)	65 65 75
	GR-5-SC GR-5-PC GR-5-PB	2-1/2" hole 2-1/2" hole 2-1/2" hole	Satin Chrome Polished Chrome Polished Brass (Solid brass plated grommets)	145 145 155

10% Add effective 7/1/2024

OPTIONS:

Grommets available in other sizes. Consult factory.
 Plastic grommets available in other colors. Consult factory.
 Metal grommets available in other finishes. Consult factory.





phone: (510) 259-6217
 email: info@actionlaminates.com

Vizion Series, Reception Furniture Table of Contents

Edge Details and Finish Specifications	176
Accessories	
Drawer and Door Pulls	191
Pencil Drawers, Keyboard Drawers	190
Metal Standoffs	189
Transaction Top Supports	189
Wire Management	190
Rectilinear Main Desks	177
Bow Front Main Desks	178
Single Radius-Corner Main Desks	179
Double Radius-Corner Main Desks	179
Single Beveled-Corner Main Desks	180
Double Beveled-Corner Main Desks	180
Main Desk with Accent Panel	181
Bridge Units	182
Return Units	183
Credenza Units	184
Pedestals	185-186
Optional Glass Transaction Tops	187-188

100% effective
 7/1/2024

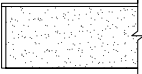
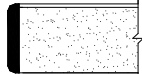
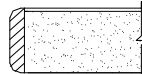
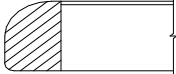
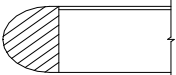
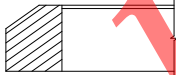
VISION SERIES EDGE DETAILS AND FINISH SPECIFICATIONS

	DESCRIPTION	STANDARD COLORS
GROUP A		
EDGE 2	<p>Self Edge</p>  <p>Core Material: 45lb high density particle board finished with high pressure laminate top, backing sheet on the bottom.</p> <p>Edge: High pressure laminate 1/16" x 1 1/4" thick.</p>	High pressure laminate matching the top. Contrasting self edge consult factory for pricing.
GROUP B		
EDGE 3	<p>PVC Edge</p>  <p>Core Material: 45lb high density particle board finished with high pressure laminate top, backing sheet on the bottom.</p> <p>Edge: PVC 3 mm x 1 1/4" thick.</p>	Antique White, Beigewood, Black, Boardwalk Oak, Cocobala, Designer White, Dove Grey, Fawn Cypress, Figured Mahogany, Fonthill Pear, Frosty White, Fusion Maple, Golden Oak, Grey 1500, Hardrock Maple, Henna Cherry, HM Innertone Light, HM Innertone-R, HM Mediumtone, HW Graphite, HW Putty, HW Smoke, Kensington Maple, Manitoba Maple, Monticello Maple, Pebble, Pepperdust, Platinum, Regency Walnut, River Cherry, Skyline Walnut, Slate, Sterling Ash, Studio Teak, Walnut Heights, Wild Cherry, Windsor Mahogany, Yorkshire Cherry, Witchcraft 1.5mm Satin Chrome
GROUP D		
EDGE 13	<p>1/8" Eased Wood Edge</p>  <p>Core Material: 45lb high density particle board finished with high pressure laminate top, backing sheet on the bottom.</p> <p>Edge: Wood edge, 1/8" x 1 1/4" thick.</p>	Species: Maple, Cherry, Oak or Walnut.
GROUP E		
EDGE 14	<p>Radius Wood Edge</p>  <p>Core Material: 45lb high density particle board finished with high pressure laminate top, backing sheet on the bottom.</p> <p>Edge: Wood edge, 3/4" x 1 1/4" thick.</p>	Species: Maple, Cherry, Oak or Walnut.
EDGE 15	<p>Bullnose Wood</p>  <p>Core Material: 45lb high density particle board finished with high pressure laminate top, backing sheet on the bottom.</p> <p>Edge: Wood edge, 3/4" x 1 1/4" thick.</p>	Species: Maple, Cherry, Oak or Walnut.
EDGE 16	<p>Bevel Wood Edge</p>  <p>Core Material: 45lb high density particle board finished with high pressure laminate top, backing sheet on the bottom.</p> <p>Edge: Wood edge, 3/4" x 1 1/4" thick.</p>	Species: Maple, Cherry, Oak or Walnut.
EDGE 17	<p>Double Beveled Wood Edge</p>  <p>Core Material: 45lb high density particle board finished with high pressure laminate top, backing sheet on the bottom.</p> <p>Edge: Wood edge, 3/4" x 1 1/4" thick.</p>	Species: Maple, Cherry, Oak or Walnut.

Laminates: Standard matte finishes in solid, wood grain, and patterns from Wilsonart, Formica, Nevamar, and Pionite.

Premium finishes or laminates by Abet laminati, Laminart, and others are available upon request.



phone: (510) 259-6217
email: info@actionlaminates.com

VIZION SERIES RECEPTION FURNITURE

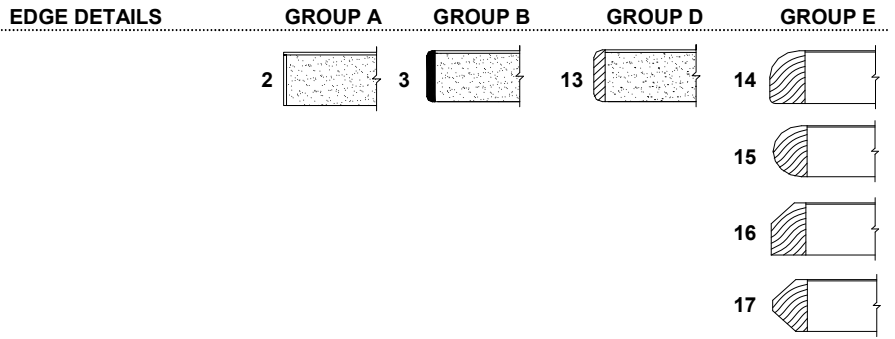

MODEL NUMBER	SIZE	WT.	GROUP A	GROUP B	GROUP D	GROUP E
--------------	------	-----	---------	---------	---------	---------

RECTILINEAR MAIN DESK SHELL, STANDARD TRANSACTION TOP

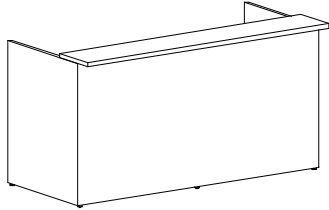

600-2460- ☐	24 x 60	209	2283	2484	2777	2979
600-2466- ☐	24 x 66	224	2536	2760	3105	3364
600-2472- ☐	24 x 72	239	2536	2760	3105	3364
600-2484- ☐	24 x 84	268	3059	3306	3795	4123
600-2496- ☐	24 x 96	297	3059	3306	3795	4123

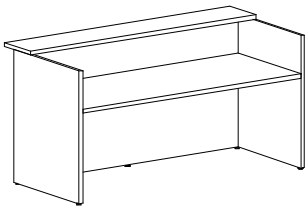

600-3060- ☐	30 x 60	236	2565	2789	3053	3266
600-3066- ☐	30 x 66	252	2835	3088	3404	3663
600-3072- ☐	30 x 72	268	2835	3088	3404	3663
600-3084- ☐	30 x 84	299	3393	3686	4129	4462
600-3096- ☐	30 x 96	331	3393	3686	4129	4462

Note: Standard transaction top is 12"d x full width, overhanging front panel 4".

RECTILINEAR MAIN DESK SHELL, BOW-FRONT TRANSACTION TOP

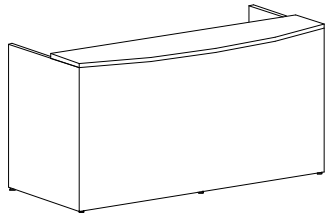

601-2460- ☐	24 x 60	215	2386	2588	2766	3117
601-2466- ☐	24 x 66	230	2639	2881	3249	3496
601-2472- ☐	24 x 72	246	2639	2881	3249	3496
601-2484- ☐	24 x 84	275	3151	3433	3922	4272
601-2496- ☐	24 x 96	306	3151	3433	3922	4272

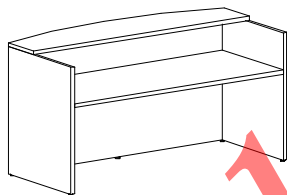

601-3060- ☐	30 x 60	242	2662	2898	3174	3404
601-3066- ☐	30 x 66	258	2933	3203	3542	3801
601-3072- ☐	30 x 72	275	2933	3203	3542	3801
601-3084- ☐	30 x 84	307	3485	3801	4255	4606
601-3096- ☐	30 x 96	340	3485	3801	4255	4606

Note: Bow front transaction top is 12/18"d x full width, overhanging front panel 6".

OPTIONS:

- Round Grommet 3" add \$ 30 List.
- See pedestal selection on Page 185-186.
- 1-1/4" recessed toe kick, at front and/or ends, add \$61 List per lineal ft.
- 1/8" reveal painted black, add \$23 List per lineal ft.
- Extra wide laminate reveal, add \$60 List per lineal ft.
- See glass transaction top selection on Page 187.

NOTES:

- Main desk shells with 3mm pvc edgebanding have 3mm pvc edgebanding on all edges.
- Main desk shells with Group D and Group E wood edge on front edge of worksurface and all edges of transaction top; balance of edges self edge.
- Standard worksurface height is 29"; standard transaction top height is 42".
- Standard with privacy end support panels and 1-1/4" thick construction.
- Standard with exterior laminate skinned to reduce number of visible seams.



phone: (510) 259-6217
email: info@actionlaminates.com

EDGE DETAILS **GROUP A** **GROUP B** **GROUP D** **GROUP E**

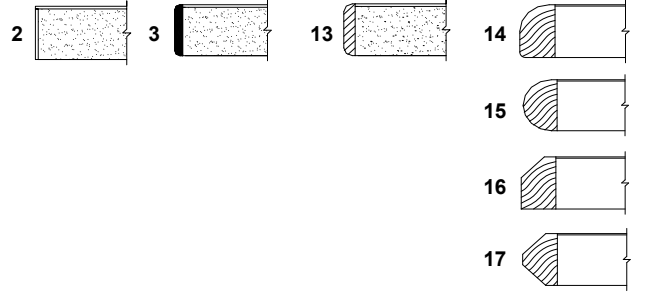

**VIZION SERIES
RECEPTION FURNITURE**

MODEL NUMBER	SIZE	WT.	GROUP A	GROUP B	GROUP D	GROUP E
--------------	------	-----	---------	---------	---------	---------

BOW-FRONT MAIN DESK SHELL, BOW-FRONT TRANSACTION TOP

602-3060- □	24/30 x 60	242	4571	4801	5095	5319
602-3066- □	24/30 x 66	258	4847	5100	5451	5710
602-3072- □	24/30 x 72	275	4847	5100	5451	5710
602-3084- □	24/30 x 84	307	5394	5704	6170	6515
602-3096- □	24/30 x 96	340	5394	5704	6170	6515
602-3660- □	30/36 x 60	269	4727	5106	5371	5601
602-3666- □	30/36 x 66	286	5141	5428	5744	6015
602-3672- □	30/36 x 72	304	5141	5428	5744	6015
602-3684- □	30/36 x 84	338	5733	6072	6503	6848
602-3696- □	30/36 x 96	374	5733	6072	6503	6848

Note: Bow front transaction top is 12/18"d x full width.

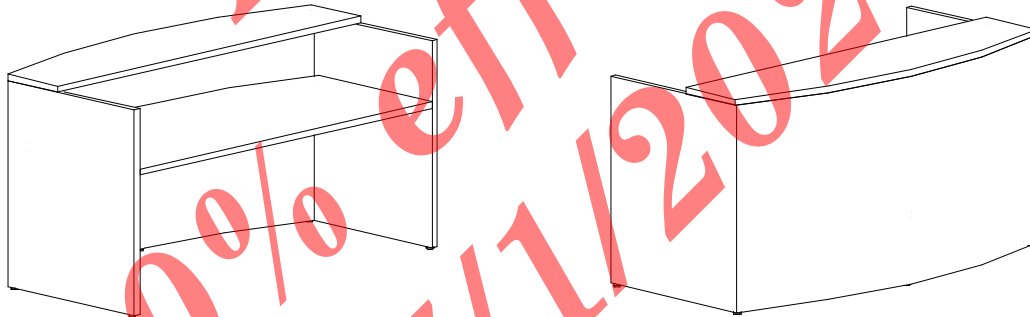

OPTIONS:

Round Grommet 3" add \$ 30 List.
See pedestal selection on Page 185-186.
1-1/4" recessed toe kick, at front and/or ends,
add \$61 List per lineal ft.
1/8" reveal painted black, add \$23 List per lineal ft.
Extra wide laminate reveal, add \$60 List per lineal ft.
See glass transaction top selection on Page 187.

NOTES:

Main desk shells with 3mm pvc edgebanding have 3mm pvc edgebanding on all edges.
Main desk shells with Group D and Group E wood edge on front edge of worksurface
and all edges of transaction top; balance of edges self edge.
Standard worksurface height is 29"; standard transaction top height is 42".
Standard with privacy end support panels and 1-1/4" thick construction.
Standard with exterior laminate skinned to reduce number of visible seams.



phone: (510) 259-6217
email: info@actionlaminates.com

VIZION SERIES RECEPTION FURNITURE

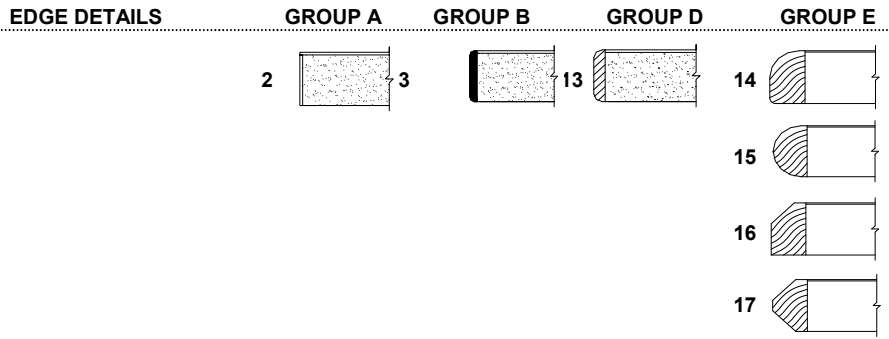

MODEL NUMBER	SIZE	WT.	GROUP A	GROUP B	GROUP D	GROUP E
--------------	------	-----	---------	---------	---------	---------

SINGLE RADIUS-CORNER MAIN DESK SHELL, L-SHAPED TRANSACTION TOP

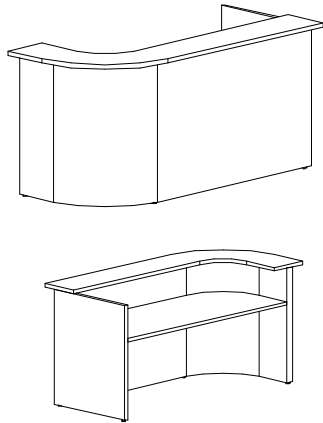

603-□-3060-□	30 x 60	242	5037	5290	5635	5900
603-□-3066-□	30 x 66	258	5411	5693	6089	6400
603-□-3072-□	30 x 72	275	5411	5693	6089	6400
603-□-3084-□	30 x 84	307	6026	6383	6889	7274
603-□-3096-□	30 x 96	340	6026	6383	6889	7274
603-□-3660-□	36 x 60	269	5445	5744	6072	6342
603-□-3666-□	36 x 66	286	5888	6222	6613	6917
603-□-3672-□	36 x 72	304	5888	6222	6613	6917
603-□-3684-□	36 x 84	338	6590	7004	7475	7878
603-□-3696-□	36 x 96	374	6590	7004	7475	7878

Note: Standard L-shaped transaction top is 12"d x full width, overhanging front and (1) end panel 4".

DOUBLE RADIUS-CORNER MAIN DESK SHELL, U-SHAPED TRANSACTION TOP

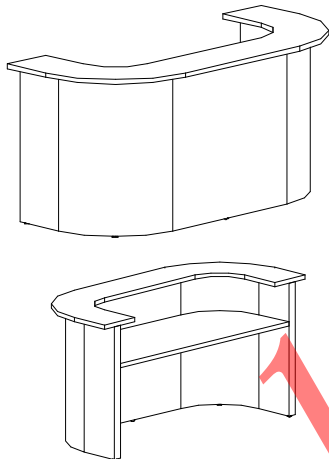

604-3060-□	30 x 60	242	5198	5451	5802	6072
604-3066-□	30 x 66	258	5572	5859	6256	6567
604-3072-□	30 x 72	275	5572	5859	6256	6567
604-3084-□	30 x 84	307	6199	6549	7055	7435
604-3096-□	30 x 96	340	6199	6549	7055	7435
604-3660-□	36 x 60	269	5612	5905	6239	6509
604-3666-□	36 x 66	286	6055	6388	6774	7084
604-3672-□	36 x 72	304	6055	6388	6774	7084
604-3684-□	36 x 84	338	6756	7165	7642	8039
604-3696-□	36 x 96	374	6756	7165	7642	8039

Note: Standard U-shaped transaction top is 12"d x full width, overhanging front and (2) end panels 4".

OPTIONS:

- Round Grommet 3" add \$ 30 List.
- See pedestal selection on Page 185-186.
- 1-1/4" recessed toe kick, at front and/or ends, add \$61 List per lineal ft.
- 1/8" reveal painted black, add \$23 List per lineal ft.
- Extra wide laminate reveal, add \$60 List per lineal ft.
- See glass transaction top selection on Page 187.

NOTES:

- Main desk shells with 3mm pvc edgebanding have 3mm pvc edgebanding on all edges.
- Main desk shells with Group D and Group E wood edge on front edge of worksurface and all edges of transaction top; balance of edges self edge.
- Standard worksurface height is 29"; standard transaction top height is 42".
- Standard with privacy end support panels.
- Please specify radius corner at left or right: add "L" or "R" after "603" in model number.
- Standard with 1-1/4" thick construction.
- Standard with exterior laminate skinned to reduce number of visible seams.



phone: (510) 259-6217
email: info@actionlaminates.com

VIZION SERIES RECEPTION FURNITURE

EDGE DETAILS

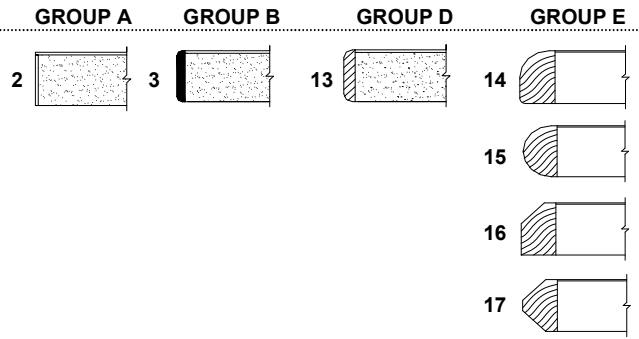

MODEL NUMBER	SIZE	WT.	GROUP A	GROUP B	GROUP D	GROUP E
--------------	------	-----	---------	---------	---------	---------

SINGLE BEVELED-CORNER MAIN DESK SHELL, L-SHAPED TRANSACTION TOP

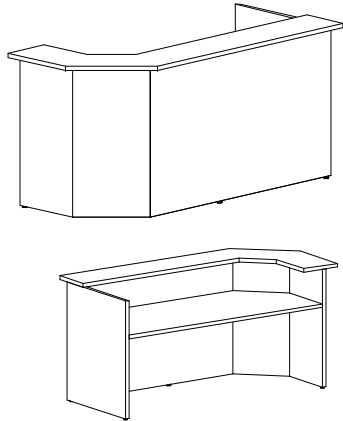

605-□-3060-□	30 x 60	242	3157	3410	3755	4031
605-□-3066-□	30 x 66	258	3531	3818	4215	4525
605-□-3072-□	30 x 72	275	3531	3818	4215	4525
605-□-3084-□	30 x 84	307	4157	4502	5008	5394
605-□-3096-□	30 x 96	340	4157	4502	5008	5394
605-□-3660-□	36 x 60	269	3577	3864	4192	4468
605-□-3666-□	36 x 66	286	4019	4347	4732	5049
605-□-3672-□	36 x 72	304	4019	4347	4732	5049
605-□-3684-□	36 x 84	338	4715	5129	5601	5997
605-□-3696-□	36 x 96	374	4715	5129	5601	5997

Note: Standard transaction top is 12"d x full width, overhanging front and (1) end panel 4".

DOUBLE BEVELED-CORNER MAIN DESK SHELL, U-SHAPED TRANSACTION TOP

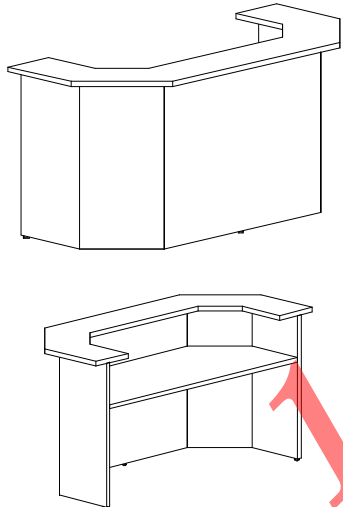

606-3060-□	30 x 60	242	3324	3577	3922	4192
606-3066-□	30 x 66	258	3692	3985	4376	4686
606-3072-□	30 x 72	275	3692	3985	4376	4686
606-3084-□	30 x 84	307	4318	4669	5175	5560
606-3096-□	30 x 96	340	4318	4669	5175	5560
606-3660-□	36 x 60	269	3732	4031	4359	4629
606-3666-□	36 x 66	286	4175	4514	4893	5210
606-3672-□	36 x 72	304	4175	4514	4893	5210
606-3684-□	36 x 84	338	4882	5290	5767	6158
606-3696-□	36 x 96	374	4882	5290	5767	6158

Note: Standard transaction top is 12"d x full width, overhanging front and (2) end panels 4".

OPTIONS:

Round Grommet 3" add \$ 30 List.
See pedestal selection on Page 185-186.
1-1/4" recessed toe kick, at front and/or ends,
add \$61 List per lineal ft.
1/8" reveal painted black, add \$23 List per lineal ft.
Extra wide laminate reveal, add \$60 List per lineal ft.
See glass transaction top selection on Page 187.

NOTES:

Main desk shells with 3mm pvc edgebanding have 3mm pvc edgebanding on all edges.
Main desk shells with Group D and Group E wood edge on front edge of worksurface
and all edges of transaction top; balance of edges self edge.
Standard worksurface height is 29"; standard transaction top height is 42".
Standard with privacy end support panels.
Please specify beveled corner at left or right: add "L" or "R" after "605" in model number.
Standard with 1-1/4" thick construction.
Standard with exterior laminate skinned to reduce number of visible seams.



EDGE DETAILS

GROUP A

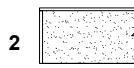

phone: (510) 259-6217
email: info@actionlaminates.com

**VIZION SERIES
RECEPTION FURNITURE**

MODEL NUMBER	SIZE	WT.	GROUP A
--------------	------	-----	---------

RECTANGULAR DESK SHELL WITH ACCENT PANEL & TRANSACTION TOP

611-□-2472-□	24/28 x 72	235	1777
611-□-2484-□	24/28 x 84	276	2110
611-□-2496-□	24/28 x 96	320	2237
611-□-24108-□	24/28 x 108	364	2645
611-□-24120-□	24/28 x 120	408	2818
611-□-3072-□	30/34 x 72	260	1909
611-□-3084-□	30/34 x 84	305	2277
611-□-3096-□	30/34 x 96	349	2404
611-□-30108-□	30/34 x 108	394	2835
611-□-30120-□	30/34 x 120	438	3007

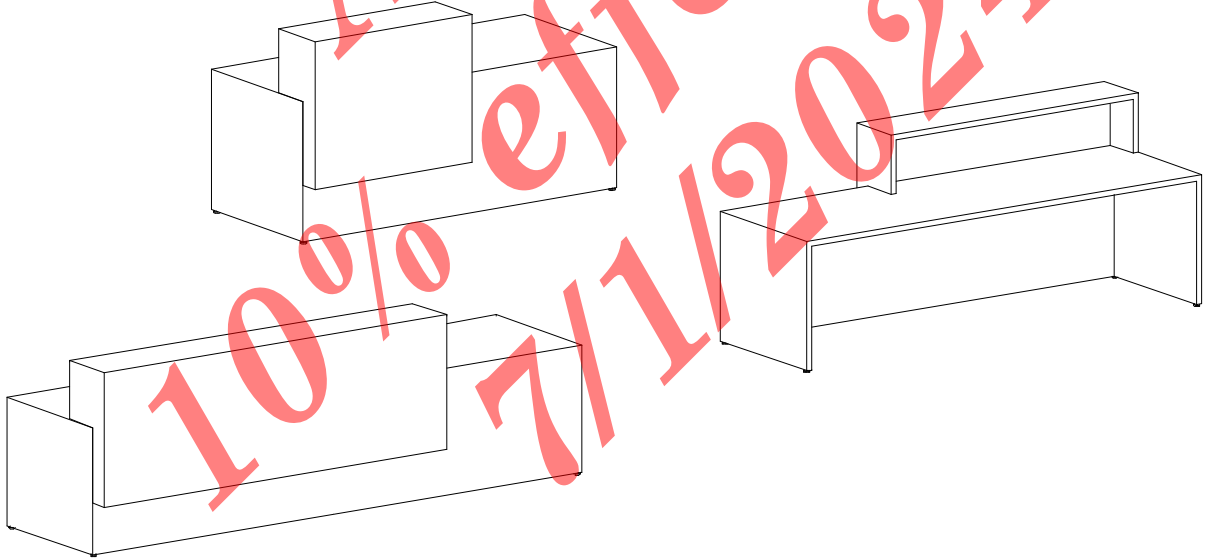

OPTIONS:

- Round Grommet 3" add \$ 30 List.
- See pedestal selection on Page 185-186.
- 1-1/4" recessed toe kick, at front and/or ends, add \$61 List per lineal ft.
- 1/8" reveal painted black, add \$23 List per lineal ft.
- Extra wide laminate reveal, add \$60 List per lineal ft.
- See glass transaction top selection on Page 187.

NOTES:

- Standard worksurface height is 29"; standard transaction top height is 42".
- Standard with skinned laminate all corners, to reduce visible seams.
- Standard with 1-1/4" thick construction.
- Standard transaction top is 12"d, with 36"w ADA section; accent panel overhangs front panel 4". Please consult factory for additional options.



phone: (510) 259-6217
email: info@actionlaminates.com

VIZION SERIES RECEPTION FURNITURE

EDGE DETAILS

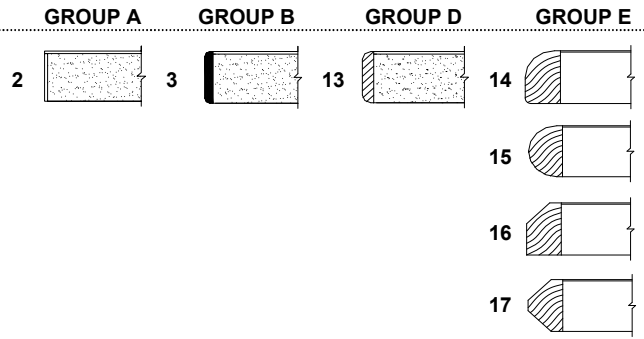

MODEL NUMBER	SIZE	WT.	GROUP A	GROUP B	GROUP D	GROUP E
--------------	------	-----	---------	---------	---------	---------

BRIDGE UNITS

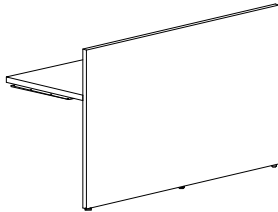

607-2036-□	20 x 36	70	673	742	874	960
607-2042-□	20 x 42	81	845	926	1075	1179
607-2048-□	20 x 48	93	845	926	1075	1179
607-2060-□	20 x 60	116	1035	1139	1300	1409
607-2072-□	20 x 72	140	1236	1351	1524	1645

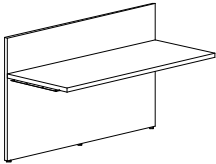

607-2436-□	24 x 36	74	673	742	874	960
607-2442-□	24 x 42	87	845	926	1075	1179
607-2448-□	24 x 48	99	845	926	1075	1179
607-2460-□	24 x 60	124	1035	1139	1300	1409
607-2472-□	24 x 72	149	1236	1351	1524	1645

607-3036-□	30 x 36	81	707	782	943	1047
607-3042-□	30 x 42	95	891	983	1144	1265
607-3048-□	30 x 48	108	891	983	1144	1265
607-3060-□	30 x 60	135	1093	1208	1380	1512
607-3072-□	30 x 72	162	1305	1432	1616	1760

OPTIONS:

- Round Grommet 3" add \$ 30 List.
- See pedestal selection on Page 185-186.
- 1-1/4" recessed toe kick, at front and/or ends,
add \$61 List per lineal ft.
- 1/8" reveal painted black, add \$23 List per lineal ft.
- Extra wide laminate reveal, add \$60 List per lineal ft.

NOTES:

- Bridge units with 3mm pvc edgebanding have 3mm pvc edgebanding on all edges.
- Bridge units with Group D and Group E wood edge on front edge of worksurface only; balance of edges self edge.
- Standard worksurface height is 29".
- Standard with attaching hardware.
- Standard with 1-1/4" thick construction.



phone: (510) 259-6217
email: info@actionlaminates.com

EDGE DETAILS

GROUP A

GROUP B

GROUP D

GROUP E

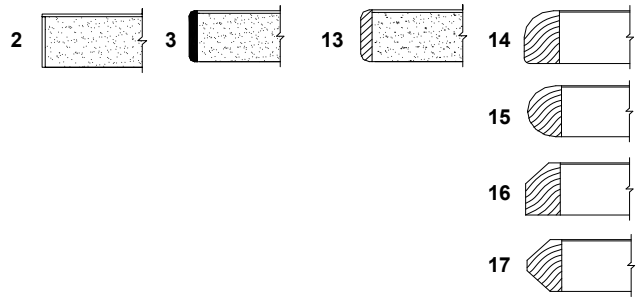

**VIZION SERIES
RECEPTION FURNITURE**

MODEL NUMBER	SIZE	WT.	GROUP A	GROUP B	GROUP D	GROUP E
--------------	------	-----	---------	---------	---------	---------

RETURN UNITS

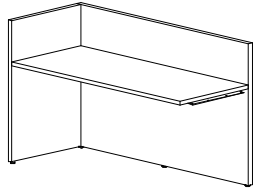

Left Return

608-□-2030-□	20 x 30	84	1081	1173	1271	1351
608-□-2036-□	20 x 36	96	1116	1208	1317	1403
608-□-2042-□	20 x 42	108	1282	1397	1512	1616
608-□-2048-□	20 x 48	119	1277	1397	1512	1616
608-□-2060-□	20 x 60	143	1478	1604	1742	1852
608-□-2072-□	20 x 72	166	1668	1829	1961	2087
608-□-2084-□	20 x 84	189	2059	2260	2409	2565
608-□-2096-□	20 x 96	212	2059	2260	2409	2565

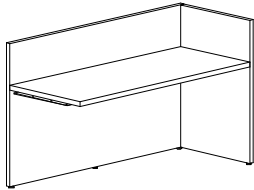

Right Return

608-□-2430-□	24 x 30	93	1081	1173	1271	1351
608-□-2436-□	24 x 36	106	1116	1208	1317	1403
608-□-2442-□	24 x 42	118	1282	1397	1512	1616
608-□-2448-□	24 x 48	131	1277	1397	1512	1616
608-□-2460-□	24 x 60	155	1478	1604	1742	1852
608-□-2472-□	24 x 72	180	1668	1829	1961	2087
608-□-2484-□	24 x 84	205	2059	2260	2409	2565
608-□-2496-□	24 x 96	230	2059	2260	2409	2565

608-□-3030-□	30 x 30	107	1190	1300	1403	1507
608-□-3036-□	30 x 36	120	1219	1323	1443	1553
608-□-3042-□	30 x 42	134	1397	1518	1650	1765
608-□-3048-□	30 x 48	147	1397	1518	1650	1765
608-□-3060-□	30 x 60	174	1599	1748	1892	2018
608-□-3072-□	30 x 72	201	1811	1967	2122	2266
608-□-3084-□	30 x 84	228	2220	2421	2593	2754
608-□-3096-□	30 x 96	255	2220	2421	2593	2754

OPTIONS:

- Round Grommet 3" add \$ 30 List.
- See pedestal selection on Page 185-186.
- 1-1/4" recessed toe kick, at front and/or ends,
add \$61 List per lineal ft.
- 1/8" reveal painted black, add \$23 List per lineal ft.
- Extra wide laminate reveal, add \$60 List per lineal ft.

NOTES:

- Please specify left or right return: add "L" or "R" after "608" in model number.
- Please specify edge detail at the end of the model number.
- Standard worksurface height is 29". Standard with flat bracket for mounting.
- Return units with 3mm pvc edgebanding have 3mm pvc on all edges.
- Return units with Group D and Group E wood edge on front edge of
worksurface only; balance of edges self edge.
- Standard with privacy end support panel and 1-1/4" thick construction.
- Standard with exterior laminate skinned to reduce number of visible seams.



phone: (510) 259-6217
email: info@actionlaminates.com

VIZION SERIES RECEPTION FURNITURE

EDGE DETAILS

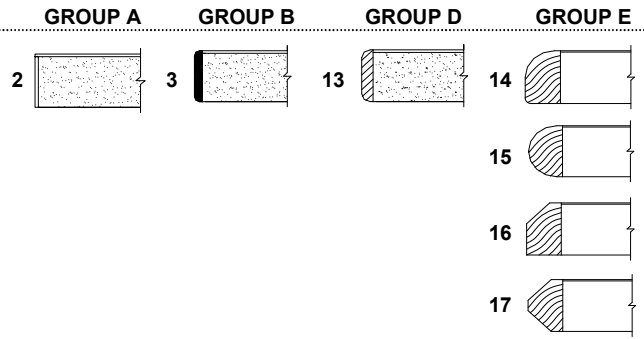

MODEL NUMBER	SIZE	WT.	GROUP A	GROUP B	GROUP D	GROUP E
--------------	------	-----	---------	---------	---------	---------

RECTILINEAR CREDENZA SHELL

609-2060-□	20 x 60	169	1886	2036	2139	2254
609-2066-□	20 x 66	180	2082	2254	2358	2467
609-2072-□	20 x 72	192	2082	2254	2358	2484
609-2084-□	20 x 84	215	2467	2680	2806	2961
609-2096-□	20 x 96	239	2467	2680	2806	2961

609-2460-□	24 x 60	187	1886	2036	2139	2254
609-2466-□	24 x 66	199	2082	2254	2358	2467
609-2472-□	24 x 72	212	2082	2254	2358	2484
609-2484-□	24 x 84	236	2467	2680	2806	2961
609-2496-□	24 x 96	261	2467	2680	2806	2961

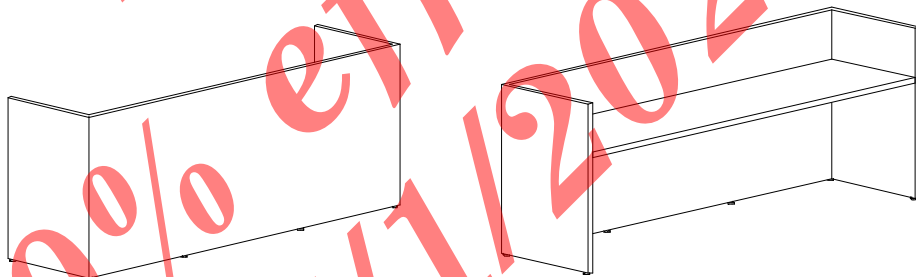

OPTIONS:

- Round Grommet 3" add \$ 30 List.
- See pedestal selection on Page 185-186.
- 1-1/4" recessed toe kick, at front and/or ends,
add \$61 List per lineal ft.
- 1/8" reveal painted black, add \$23 List per lineal ft.
- Extra wide laminate reveal, add \$60 List per lineal ft.

NOTES:

- Please specify edge detail at the end of the model number.
- Credenza units with 3mm pvc edgebanding have 3mm pvc edgebanding on all edges.
- Credenza units with Group D and Group E wood edge on front edge of worksurface only; balance of edges self edge.
- Standard worksurface height is 29".
- Construction standard with 1-1/4" thick material.
- Standard with exterior laminate skinned to reduce number of visible seams.



phone: (510) 259-6217
email: info@actionlaminates.com

EDGE DETAILS

GROUP A

GROUP B



VIZION PEDESTALS

	MODEL NUMBER	SIZE	WT.	GROUP A	GROUP B
FLOOR SUPPORT		D x W x H			
BBF	610-FS-BBF-18-□	18 x 16 x 27.75	90	822	880
	610-FS-BBF-23-□	23 x 16 x 27.75	95	868	937
	610-FS-BBF-29-□	29 x 16 x 27.75	100	932	989
FLOOR SUPPORT					
	610-FS-FF-18-□	18 x 16 x 27.75	90	822	880
	610-FS-FF-23-□	23 x 16 x 27.75	95	868	937
	610-FS-FF-29-□	29 x 16 x 27.75	100	932	989
MOBILE					
	610-M-BBF-18-□	18 x 16 x 27.5	90	932	989
	610-M-BBF-23-□	23 x 16 x 27.5	95	978	1046
	610-M-BBF-29-□	29 x 16 x 27.5	100	1046	1110
MOBILE					
	610-M-FF-18-□	18 x 16 x 27.5	90	932	989
	610-M-FF-23-□	23 x 16 x 27.5	95	978	1046
	610-M-FF-29-□	29 x 16 x 27.5	100	1046	1110
MOBILE					
	610-M-BBB-18-□	18 x 16 x 27.5	90	695	765
	610-M-BBB-23-□	23 x 16 x 27.5	95	753	822
	610-M-BBB-29-□	29 x 16 x 27.5	100	822	880
MOBILE					
	610-M-BF-18-□	18 x 16 x 22.5	80	695	765
	610-M-BF-23-□	23 x 16 x 22.5	85	753	822
	610-M-BF-29-□	29 x 16 x 22.5	90	822	880
MOBILE					
	610-M-BFC-18-□	18 x 16 x 24.5	85	1081	1144
	610-M-BFC-23-□	23 x 16 x 24.5	90	1127	1196
	610-M-BFC-29-□	29 x 16 x 24.5	95	1196	1265

OPTIONS:

Arc pulls in polished chrome or satin chrome, no up charge.
Master key, \$30.
Key-change tool, \$30.

NOTES:

All pedestals are standard with lock.
Standard with Arc Pulls in black.
Floor support pedestals standard with finished back and non-finished top.
Mobile pedestals have finished tops.
Standard filing hardware, pedestals:
letter front-to-back; legal side-to-side
Cushion is wood-backed, w/ French box seams, attached to pedestal. Standard fabric.
Custom fabrics available, consult factory.



phone: (510) 259-6217
email: info@actionlaminates.com

EDGE DETAILS

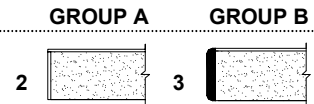

VIZION FLOOR SUPPORT LATERAL FILE AND FILE CENTER

MODEL NUMBER	SIZE	WT.	GROUP A	GROUP B
--------------	------	-----	---------	---------

FLOOR SUPPORT LATERAL FILE

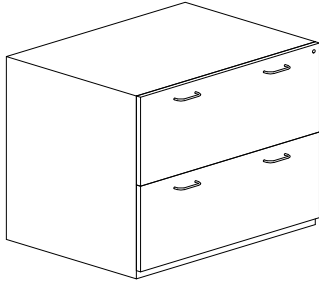

MODEL NUMBER	SIZE	WT.	Columns of letter size files, front-to-back	GROUP A	GROUP B
610-FS-LF-1930-	19 x 30 x 27.75	135	2	1374	1472
610-FS-LF-2330-	23 x 30 x 27.75	145	2	1432	1530
610-FS-LF-1936-	19 x 36 x 27.75	155	2	1472	1564
610-FS-LF-2336-	23 x 36 x 27.75	165	2	1530	1633
610-FS-LF-1941-	19 x 42 x 27.75	175	3	1633	1731
610-FS-LF-2342-	23 x 42 x 27.75	185	3	1696	1794

FLOOR SUPPORT FILE CENTER

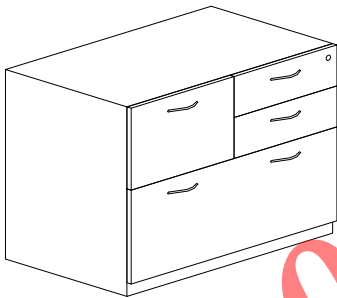

610-FS-FC-1932-	19 x 32 x 27.75	135	2	1829	1955
610-FS-FC-2332-	23 x 32 x 27.75	145	2	1926	2053

Add 10% effective 7/1/2024

OPTIONS:

Arc pulls in polished chrome or satin chrome, no upcharge.
Master key, \$30.
Key-change tool, \$30.

FILE CENTER CONFIGURATIONS:

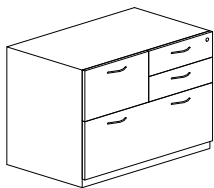

LEFT

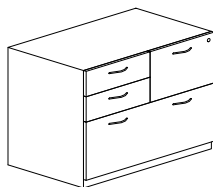

RIGHT

NOTES:

Standard lock on File Center locks drawer(s) at right and lateral drawer.
Standard with Arc Pulls in black.
Standard with finished back and non finished top.
Please specify file center configuration.
Standard filing hardware, lateral files: letter front-to-back; legal side-to-side

**VIZION SERIES
ACCESSORIE**

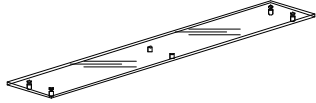
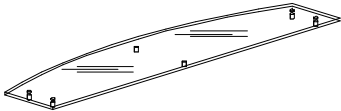
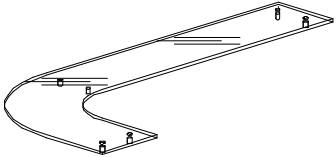
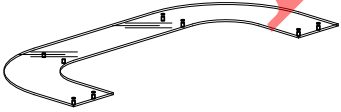
	MODEL NUMBER	SIZE	WT.		LIST PRICE
GLASS TRANSACTION TOP					
including metal stand-offs		D x W		No. of stand-offs included	
	Rectangular				
	623-G-1230	12 x 30	16	4	845
	623-G-1236	12 x 36	20	4	888
	623-G-1242	12 x 42	23	4	924
	623-G-1248	12 x 48	26	4	966
	623-G-1254	12 x 54	29	6	1322
	623-G-1260	12 x 60	32	6	1352
	623-G-1266	12 x 66	35	6	1395
	623-G-1272	12 x 72	38	6	1437
	623-G-1284	12 x 84	45	6	1515
	623-G-1296	12 x 96	51	6	1588
					
Bow Front					
	624-G-1860	12/18 x 60	40	6	2047
	624-G-1866	12/18 x 66	44	6	2131
	624-G-1872	12/18 x 72	48	6	2216
	624-G-1884	12/18 x 84	56	6	2699
	624-G-1896	12/18 x 96	64	6	2874
					
Extended L-shape with (1) radius corner					
	625-□-12-3464	12 x 34 x 64	46	6	2747
	625-□-12-3470	12 x 34 x 70	49	6	2874
	625-□-12-3476	12 x 34 x 76	52	8	3303
	625-□-12-3488	12 x 34 x 88	59	8	3556
	625-□-12-34100	12 x 34 x 100	66	8	3798
					
Right Extension shown above					
	625-□-12-4064	12 x 40 x 64	49	6	2934
	625-□-12-4070	12 x 40 x 70	52	6	3073
	625-□-12-4076	12 x 40 x 76	55	8	3526
	625-□-12-4088	12 x 40 x 88	62	8	3798
	625-□-12-40100	12 x 40 x 100	69	8	4069
U-shape with (2) radius corners					
	626-12-3468	12 x 34 x 68	60	8	3284
	626-12-3474	12 x 34 x 74	63	8	3411
	626-12-3480	12 x 34 x 80	66	8	3629
	626-12-3492	12 x 34 x 92	73	10	4087
	626-12-34104	12 x 34 x 104	80	10	4335
					

OPTIONS:

Other thicknesses of glass are available: please consult factory.
 Other colors of glass are available: please consult factory
 Other edge details available: please consult factory.
 Patterned glass available: please consult factory.
 Frosted glass available: please consult factory.
 Other standoff finishes are available, please consult factory.

NOTES:

Glass transaction tops are 1/2" thick, clear, tempered with flat polish edge.
 Please specify left or right extension: add "L" or "R" after "625" in model number
 Standard metal standoffs are 3/4" dia. x 1" high, with cap, polished chrome finish.



phone: (510) 259-6217
email: info@actionlaminates.com

VIZION SERIES ACCESSORIES

MODEL NUMBER	SIZE	WT.	LIST PRICE	
	D x W		No. of stand-offs included	
GLASS TRANSACTION TOP				
including metal stand-offs				
U-shape with (2) radius corners				
626-12-4068	12 x 40 x 68	66	8	3462
626-12-4074	12 x 40 x 74	69	8	3594
626-12-4080	12 x 40 x 80	72	10	4044
626-12-4092	12 x 40 x 92	79	10	4314
626-12-40104	12 x 40 x 104	86	10	4584
Extended L-shape with (1) beveled corner				
627-□-12-3464	12 x 34 x 64	46	6	2730
627-□-12-3470	12 x 34 x 70	49	6	2856
627-□-12-3476	12 x 34 x 76	52	8	3282
627-□-12-3488	12 x 34 x 88	59	8	3534
627-□-12-34100	12 x 34 x 100	66	8	3774
627-□-12-4064	12 x 40 x 64	49	6	2916
627-□-12-4070	12 x 40 x 70	52	6	3054
627-□-12-4076	12 x 40 x 76	55	8	3504
627-□-12-4088	12 x 40 x 88	62	8	3774
627-□-12-40100	12 x 40 x 100	69	8	4044
U-shape with (2) beveled corners				
628-12-3468	12 x 34 x 68	60	8	3264
628-12-3474	12 x 34 x 74	63	8	3390
628-12-3480	12 x 34 x 80	66	10	3606
628-12-3492	12 x 34 x 92	73	10	4062
628-12-34104	12 x 34 x 104	80	10	4308
628-12-4068	12 x 40 x 68	66	8	3462
628-12-4074	12 x 40 x 74	69	8	3594
628-12-4080	12 x 40 x 80	72	10	4044
628-12-4092	12 x 40 x 92	79	10	4314
628-12-40104	12 x 40 x 104	86	10	4584

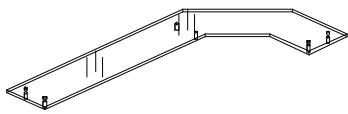
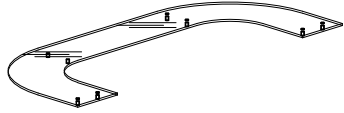

Left Extension shown above

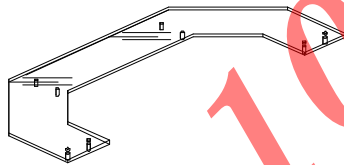

OPTIONS:

- Other thicknesses of glass are available: please consult factory.
- Other colors of glass are available: please consult factory
- Other edge details available: please consult factory.
- Patterned glass available: please consult factory.
- Frosted glass available: please consult factory.
- Other standoff finishes are available, please consult factory.



NOTES:

- Glass transaction tops are 1/2" thick, clear, tempered with flat polish edge.
- Please specify left or right extension: add "L" or "R" after "627" in model number
- Standard metal standoffs are 3/4" dia. x 1" high, with cap, polished chrome finish.



phone: (510) 259-6217
 email: info@actionlaminates.com

VIZION SERIES ACCESSORIES

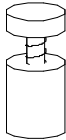
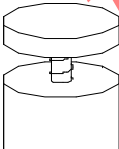
	MODEL NUMBER	SIZE D x W x H	WT.	LIST PRICE
TAPERED TRANSACTION- TOP SUPPORTS				
	TTS-36	3 x 1-1/4 x 36	5	178
TAPERED TRANSACTION- TOP RISER/SUPPORTS				
	TTR-36	8 x 1-1/4 x 36	7	247
METAL STANDOFFS, with cap 3/4" DIAMETER				
	Diameter x Height			
	MSO-751	3/4 x 1		40
	MSO-752	3/4 x 2		46
	MSO-754	3/4 x 4		69
	MSO-756	3/4 x 6		109
METAL STANDOFFS, with cap 1-1/4" DIAMETER				
	MSO-1141	1-1/4 x 1		58
	MSO-1142	1-1/4 x 2		75
	MSO-1144	1-1/4 x 4		121
	MSO-1146	1-1/4 x 6		161

OPTIONS:

Metal standoffs available in brass, polished chrome, brushed stainless, polished stainless, and gun metal finishes at no upcharge, please specify.





NOTES:

Standard finish on metal standoffs is satin chrome.
 Price for metal standoff includes cap.

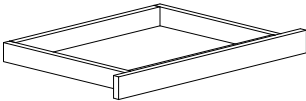
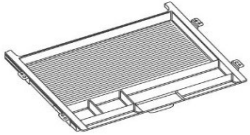
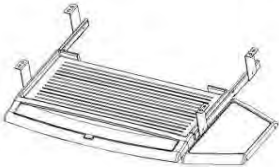

phone: (510) 259-6217
email: info@actionlaminates.com

VIZION SERIES ACCESSORIES

	MODEL NUMBER	SIZE D x W x H	WT.	FINISH	LIST PRICE
PENCIL DRAWER, LAMINATE FRONT					
	PD-24	16 x 24 x 3	15	Standard matte finish laminate front	185
PLASTIC PENCIL DRAWER					
	PPD-21	19 x 21 x 2	5	Black plastic	88
PLASTIC KEYBOARD TRAY					
	PKT-26	18-1/4 X 21/26-1/4 X 2	5	Black plastic	95
HORIZONTAL WIRE MANAGER					
	WM-2-□	1-1/4" x 2-1/2"		Black plastic	12
VERTICAL WIRE MANAGER					
	VWM-1-□	2 X 22		Black plastic Silver plastic	33 33
ONE-PIECE VERTICAL WIRE MANAGER					
	WM-1-□	2-5/16" X 15/16"		Black plastic Silver plastic	12



phone: (510) 259-6217
 email: info@actionlaminates.com

VIZION SERIES ACCESSORIES - DOOR / DRAWER PULLS

	MODEL NUMBER	SIZE	WT.	FINISH	LIST PRICE
	PULL-1	5" C-to-C		Black, Polished Chrome, Satin Chrome, Nickel Matte	8 All
	PULL-2	5" C-to-C		Brushed Stainless Steel Black Matte	8 S.S.
	PULL-3	5" C-to-C		Matte Chrome, Matte Nickel	18 All
	PULL-4	5" C-to-C		Brushed Nickel	13 B. N.
	PULL-5	4" C-to-C		Silver Anodized, Bronze, Matte Silver, Satin Chrome, Polished Black, Polished Chrome	38 All
	PULL-6	2" C-to-C		Black, Polished Chrome, Satin Chrome	23 All
	PULL-7	5" C-to-C		Matt Stainless Steel	30 Matt S.S
	PULL-8	5" C-to-C		Stainless Steel	13 All
	PULL-9	2-1/2" C-to-C		Black, Polished Chrome, Stainless Steel	24 Black 35 Chrome 35 S.S.
	PULL -10	5" C-to-C		Polished Chrome Stainless Steel	14 Chrome 12 S.S.

10% off effective 7/1/2024

OPTIONS:
 Many other pull styles are available, please consult factory.

NOTES:



phone: (510) 259-6217
email: info@actionlaminates.com

Econoline Series Table of Contents

Edge Details and Finish Specifications	193
Commercial Cabinets	
Base Cabinets	200-203
Upper Cabinets	194-199
Mail Organizers	
Hutch-style	205
Wall Mount	204
Specialty Components	
Open Cubbie Units	206

Add
10% effective
7/1/2024



phone: (510) 259-6217
email: info@actionlaminates.com

ECONOLINE SERIES EDGE DETAILS AND FINISH SPECIFICATIONS

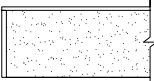
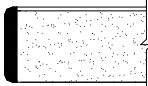
DOOR CONSTRUCTION	DESCRIPTION	Edge Colors
<p>Self Edge</p> <p>EDGE 2 </p>	<p>Core Material: 3/4" thick (7/8" total thickness), 45lb high density particle board finished with standard matte finish laminate both faces.</p>	<p>Self Edge: same color as laminate.</p>
<p>3mm PVC Edge</p> <p>EDGE 3 </p>	<p>Core Material: 3/4" thick (7/8" total thickness), 45lb high density particle board finished with standard matte finish laminate both faces.</p>	<p>Antique White, Beigewood, Black, Boardwalk Oak, Cocobala, Designer White, Dove Grey, Fawn Cypress, Figured Mahogany, Fonthill Pear, Frosty White, Fusion Maple, Golden Oak, Grey 1500, Hardrock Maple, Henna Cherry, HM Innertone Light, HM Innertone-R, HM Mediumtone, HW Graphite, HW Putty, HW Smoke, Kensington Maple, Manitoba Maple, Monticello Maple, Pebble, Pepperdust, Platinum, Regency Walnut, River Cherry, Skyline Walnut, Slate, Sterling Ash, Studio Teak, Walnut Heights, Wild Cherry, Windsor Mahogany, Yorkshire Cherry, Witchcraft</p> <p>1.5mm Satin Chrome</p>

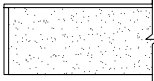
CASE CONSTRUCTION	DESCRIPTION	Edge Colors
<p>1/2mm PVC Edge</p> <p></p>	<p>Core Material: 3/4" thick, 45lb high density particle board finished with melamine both faces. Standard color melamine: Black, White, Folkstone Grey, Hard Rock Maple, Wild Cherry.</p>	<p>1/2mm pvc edgebanding: same color as melamine.</p>

Laminates: Standard matte finishes in solid, wood grain, and patterns from Wilsonart, Formica, Nevamar, and Pionite.
Premium finishes or laminates by Abet laminati, Laminart, and others are available upon request.



phone: (510) 259-6217
email: info@actionlaminates.com

EDGE DETAILS

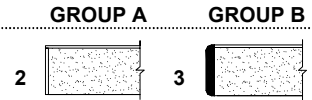

LAMINATE DOORS

ECONOLINE

MELAMINE WALL MOUNT UPPER CABINET, 12" DEEP X 24" HIGH

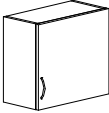
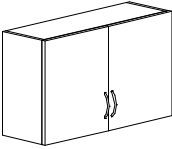
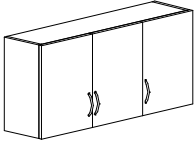
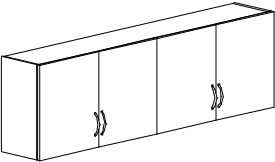
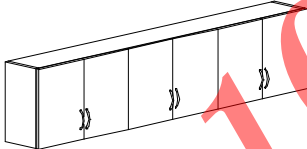
	MODEL NUMBER	SIZE	WT.	ADJ. SHELVES	Doors Only GROUP A	Doors Only GROUP B
D x W x H						
ONE DOOR						
	518-□-2424-□	12 x 24 x 24	54	1	368	408
	Extra Shelf, 12"d x 24"w, add \$40 List Price.					
TWO DOORS						
	518-3024-□	12 x 30 x 24	65	1	437	477
	518-3624-□	12 x 36 x 24	75	1	512	558
	Extra Shelf, 12"d x 30"w, add \$46 List Price.					
	Extra Shelf, 12"d x 36"w, add \$58 List Price.					
THREE DOORS						
	518-□-4224-□	12 x 42 x 24	92	2	621	690
	518-□-4824-□	12 x 48 x 24	102	2	690	765
	Extra Shelf, 12"d x 28"w, add \$46 List Price.					
	Extra Shelf, 12"d x 32"w, add \$58 List Price.					
FOUR DOORS						
	518-6024-□	12 x 60 x 24	123	2	845	932
	518-7224-□	12 x 72 x 24	144	2	983	1081
	Extra Shelf, 12"d x 30"w, add \$46 List Price.					
	Extra Shelf, 12"d x 36"w, add \$58 List Price.					
SIX DOORS						
	518-8424-□	12 x 84 x 24	171	3	1167	1288
	518-9624-□	12 x 96 x 24	192	3	1311	1455
	Extra Shelf, 12"d x 28"w, add \$46 List Price.					
	Extra Shelf, 12"d x 32"w, add \$58 List Price.					

OPTIONS:

- Single door lock add \$50 list.
- Lock for pair of doors, add \$70 list.
- Arc pulls in polished chrome or satin chrome, no up charge.
- Master key, \$30.
- Key-change tool, \$30.
- Flush bottom (no fascia), no up charge.
- Task light not included; see accessories page 119.

NOTES:

- Doors are 7/8" thick with standard matte finish laminate.
- Standard color melamine case with 1/2mm pvc edgebanding.
- Single door units, specify hinge at left or right:
add "L" or "R" after "518" in model number.
- Three door units, specify single door at left or right:
add "L" or "R" after "518" in model number.
- Please specify edge detail at the end of the model number.
- Standard with Arc Pulls in black.
- Standard with recessed back and wall cleat.
- Standard with task light fascia.



phone: (510) 259-6217
email: info@actionlaminates.com

EDGE DETAILS

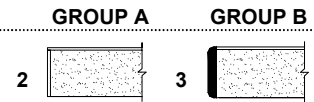

LAMINATE DOORS

ECONOLINE

MELAMINE WALL MOUNT UPPER CABINET, 12" DEEP X 30" HIGH

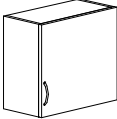
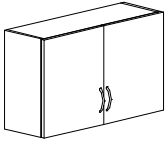
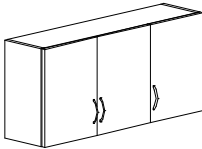
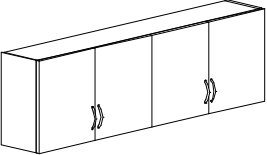
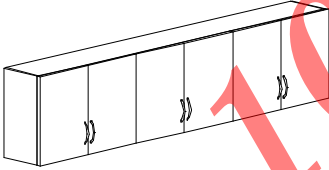
	MODEL NUMBER	SIZE	WT.	ADJ. SHELVES	Doors Only GROUP A	Doors only GROUP B
D x W x H						
ONE DOOR						
	518-□-2430-□	12 x 24 x 30	69	1	460	512
	Extra Shelf, 12"d x 24"w, add \$40 List Price.					
TWO DOORS						
	518-3030-□	12 x 30 x 30	83	1	558	615
	518-3630-□	12 x 36 x 30	96	1	650	719
	Extra Shelf, 12"d x 30"w, add \$46 List Price.					
	Extra Shelf, 12"d x 36"w, add \$58 List Price.					
THREE DOORS						
	518-□-4230-□	12 x 42 x 30	117	2	788	868
	518-□-4830-□	12 x 48 x 30	131	2	886	972
	Extra Shelf, 12"d x 28"w, add \$46 List Price.					
	Extra Shelf, 12"d x 32"w, add \$58 List Price.					
FOUR DOORS						
	518-6030-□	12 x 60 x 30	158	2	1070	1179
	518-7230-□	12 x 72 x 30	185	2	1259	1386
	Extra Shelf, 12"d x 30"w, add \$46 List Price.					
	Extra Shelf, 12"d x 36"w, add \$58 List Price.					
SIX DOORS						
	518-8430-□	12 x 84 x 30	219	3	1495	1639
	518-9630-□	12 x 96 x 30	246	3	1673	1846
	Extra Shelf, 12"d x 28"w, add \$46 List Price.					
	Extra Shelf, 12"d x 32"w, add \$58 List Price.					

OPTIONS:

- Single door lock add \$50 list.
- Lock for pair of doors, add \$70 list.
- Arc pulls in polished chrome or satin chrome, no up charge.
- Master key, \$30.
- Key-change tool, \$30.
- Flush bottom (no fascia), no up charge.
- Task light not included; see accessories page 119.

NOTES:

- Doors are 7/8" thick with standard matte finish laminate.
- Standard color melamine case with 1/2mm pvc edgebanding.
- Single door units, specify hinge at left or right:
add "L" or "R" after "518" in model number.
- Three door units, specify single door at left or right:
add "L" or "R" after "518" in model number.
- Please specify edge detail at the end of the model number.
- Standard with Arc Pulls in black.
- Standard with recessed back and wall cleat.
- Standard with task light fascia.



phone: (510) 259-6217
email: info@actionlaminates.com

EDGE DETAILS

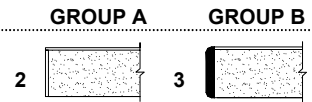

LAMINATE DOORS

ECONOLINE

MELAMINE WALL MOUNT UPPER CABINET, 12" DEEP X 36" HIGH

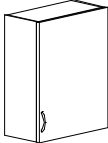
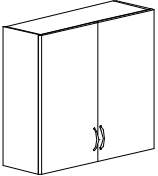
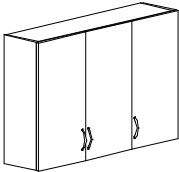
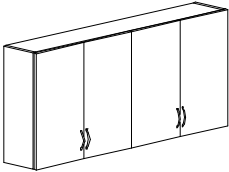
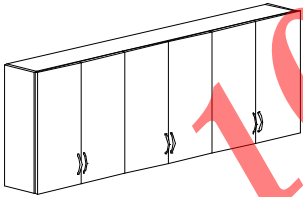
	MODEL NUMBER	SIZE	WT.	ADJ. SHELVES	Doors Only GROUP A	Doors Only GROUP B
D x W x H						
ONE DOOR						
	518-□-2436-□	12 x 24 x 36	84	2	564	621
	Extra Shelf, 12"d x 24"w, add \$40 List Price.					
TWO DOORS						
	518-3036-□	12 x 30 x 36	101	2	679	753
	518-3636-□	12 x 36 x 36	117	2	799	874
	Extra Shelf, 12"d x 30"w, add \$46 List Price.					
	Extra Shelf, 12"d x 36"w, add \$58 List Price.					
THREE DOORS						
	518-□-4236-□	12 x 42 x 36	143	4	960	1058
	518-□-4836-□	12 x 48 x 36	159	4	1075	1179
	Extra Shelf, 12"d x 28"w, add \$46 List Price.					
	Extra Shelf, 12"d x 32"w, add \$58 List Price.					
FOUR DOORS						
	518-6036-□	12 x 60 x 36	192	4	1305	1438
	518-7236-□	12 x 72 x 36	225	4	1530	1679
	Extra Shelf, 12"d x 30"w, add \$46 List Price.					
	Extra Shelf, 12"d x 36"w, add \$58 List Price.					
SIX DOORS						
	518-8436-□	12 x 84 x 36	267	6	1817	1995
	518-9636-□	12 x 96 x 36	300	6	2041	2254
	Extra Shelf, 12"d x 28"w, add \$46 List Price.					
	Extra Shelf, 12"d x 32"w, add \$58 List Price.					

OPTIONS:

- Single door lock add \$50 list.
- Lock for pair of doors, add \$70 list.
- Arc pulls in polished chrome or satin chrome, no up charge.
- Master key, \$30.
- Key-change tool, \$30.
- Flush bottom (no fascia), no up charge.
- Task light not included; see accessories page 119.

NOTES:

- Doors are 7/8" thick with standard matte finish laminate.
- Standard color melamine case with 1/2mm pvc edgebanding.
- Single door units, specify hinge at left or right:
add "L" or "R" after "518" in model number.
- Three door units, specify single door at left or right:
add "L" or "R" after "518" in model number.
- Please specify edge detail at the end of the model number.
- Standard with Arc Pulls in black.
- Standard with recessed back and wall cleat.
- Standard with task light fascia.



phone: (510) 259-6217
email: info@actionlaminates.com

EDGE DETAILS

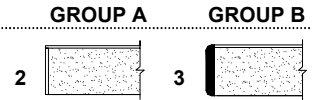

LAMINATE DOORS

ECONOLINE

MELAMINE WALL MOUNT UPPER CABINET, 15" DEEP X 24" HIGH

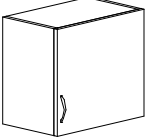
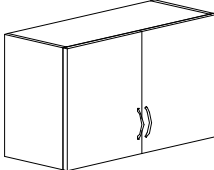
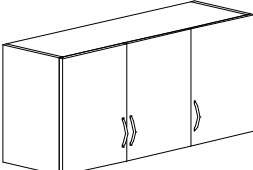
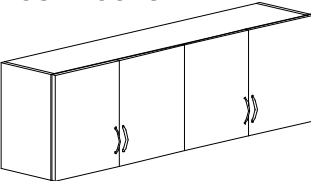
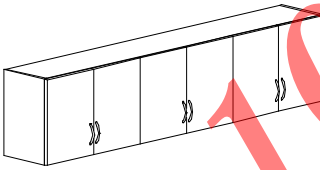
	MODEL NUMBER	SIZE	WT.	ADJ. SHELVES	Doors Only GROUP A	Doors Only GROUP B
D x W x H						
ONE DOOR						
	519-□-2424-□	15 x 24 x 24	64	1	426	466
	Extra Shelf, 15"d x 24"w, add \$52 List Price.					
TWO DOORS						
	519-3024-□	15 x 30 x 24	76	1	512	558
	519-3624-□	15 x 36 x 24	88	1	587	644
	Extra Shelf, 15"d x 30"w, add \$63 List Price.					
	Extra Shelf, 15"d x 36"w, add \$75 List Price.					
THREE DOORS						
	519-□-4224-□	15 x 42 x 24	108	2	719	788
	519-□-4824-□	15 x 48 x 24	120	2	799	880
	Extra Shelf, 15"d x 28"w, add \$63 List Price.					
	Extra Shelf, 15"d x 32"w, add \$75 List Price.					
FOUR DOORS						
	519-6024-□	15 x 60 x 24	144	2	966	1064
	519-7224-□	15 x 72 x 24	168	2	1127	1242
	Extra Shelf, 15"d x 30"w, add \$63 List Price.					
	Extra Shelf, 15"d x 36"w, add \$75 List Price.					
SIX DOORS						
	519-8424-□	15 x 84 x 24	200	3	1340	1478
	519-9624-□	15 x 96 x 24	224	3	1507	1656
	Extra Shelf, 15"d x 28"w, add \$63 List Price.					
	Extra Shelf, 15"d x 32"w, add \$75 List Price.					

OPTIONS:

- Single door lock add \$50 list.
- Lock for pair of doors, add \$70 list.
- Arc pulls in polished chrome or satin chrome, no up charge.
- Master key, \$30.
- Key-change tool, \$30.
- Flush bottom (no fascia), no up charge.
- Task light not included; see accessories page 119.

NOTES:

- Doors are 7/8" thick with standard matte finish laminate.
- Standard color melamine case with 1/2mm pvc edgebanding.
- Single door units, specify hinge at left or right:
add "L" or "R" after "519" in model number.
- Three door units, specify single door at left or right:
add "L" or "R" after "519" in model number.
- Please specify edge detail at the end of the model number.
- Standard with Arc Pulls in black.
- Standard with recessed back and wall cleat.
- Standard with task light fascia.



phone: (510) 259-6217
email: info@actionlaminates.com

EDGE DETAILS

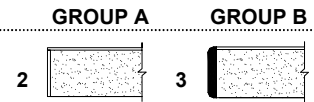

LAMINATE DOORS

ECONOLINE

MELAMINE WALL MOUNT UPPER CABINET, 15" DEEP X 30" HIGH

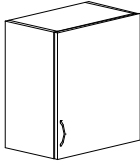
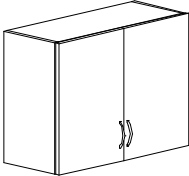
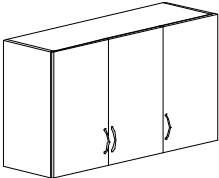
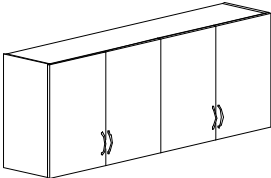
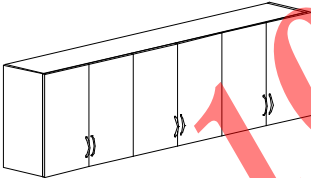
	MODEL NUMBER	SIZE	WT.	ADJ. SHELVES	Doors Only GROUP A	Doors Only GROUP B
ONE DOOR		D x W x H				
	519-□-2430-□	15 x 24 x 30	82	1	541	604
	Extra Shelf, 15"d x 24"w, add \$52 List Price.					
TWO DOORS						
	519-3030-□	15 x 30 x 30	98	1	650	713
	519-3630-□	15 x 36 x 30	113	1	759	828
	Extra Shelf, 15"d x 30"w, add \$63 List Price.					
	Extra Shelf, 15"d x 36"w, add \$75 List Price.					
THREE DOORS						
	519-□-4230-□	15 x 42 x 30	139	2	914	1006
	519-□-4830-□	15 x 48 x 30	154	2	1024	1133
	Extra Shelf, 15"d x 28"w, add \$63 List Price.					
	Extra Shelf, 15"d x 32"w, add \$75 List Price.					
FOUR DOORS						
	519-6030-□	15 x 60 x 30	185	2	1242	1369
	519-7230-□	15 x 72 x 30	216	2	1455	1593
	Extra Shelf, 15"d x 30"w, add \$63 List Price.					
	Extra Shelf, 15"d x 36"w, add \$75 List Price.					
SIX DOORS						
	519-8430-□	15 x 84 x 30	257	3	1725	1898
	519-9630-□	15 x 96 x 30	288	3	1932	2128
	Extra Shelf, 15"d x 28"w, add \$63 List Price.					
	Extra Shelf, 15"d x 32"w, add \$75 List Price.					

OPTIONS:

- Single door lock add \$50 list.
- Lock for pair of doors, add \$70 list.
- Arc pulls in polished chrome or satin chrome, no up charge.
- Master key, \$30.
- Key-change tool, \$30.
- Flush bottom (no fascia), no up charge.
- Task light not included; see accessories page 119.

NOTES:

- Doors are 7/8" thick with standard matte finish laminate.
- Standard color melamine case with 1/2mm pvc edgebanding.
- Single door units, specify hinge at left or right:
add "L" or "R" after "519" in model number.
- Three door units, specify single door at left or right:
add "L" or "R" after "519" in model number.
- Please specify edge detail at the end of the model number.
- Standard with Arc Pulls in black.
- Standard with recessed back and wall cleat.
- Standard with task light fascia.



phone: (510) 259-6217
email: info@actionlaminates.com

EDGE DETAILS

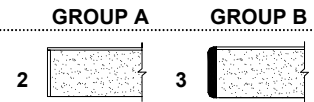

LAMINATE DOORS

ECONOLINE

MELAMINE WALL MOUNT UPPER CABINET, 15" DEEP X 36" HIGH

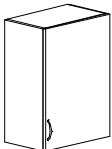
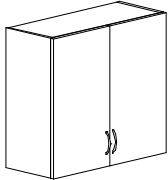
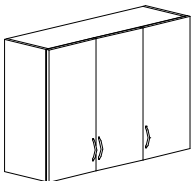
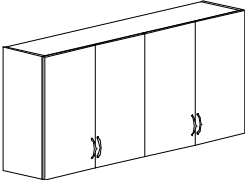
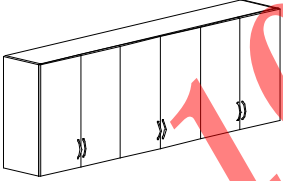
	MODEL NUMBER	SIZE	WT.	ADJ. SHELVES	Doors Only GROUP A	Doors Only GROUP B
D x W x H						
ONE DOOR						
	519-□-2436-□	15 x 24 x 36	100	2	656	730
	Extra Shelf, 15"d x 24"w, add \$52 List Price.					
TWO DOORS						
	519-3036-□	15 x 30 x 36	119	2	788	868
	519-3636-□	15 x 36 x 36	138	2	914	1006
	Extra Shelf, 15"d x 30"w, add \$63 List Price.					
	Extra Shelf, 15"d x 36"w, add \$75 List Price.					
THREE DOORS						
	519-□-4236-□	15 x 42 x 36	169	4	1127	1231
	519-□-4836-□	15 x 48 x 36	188	4	1254	1380
	Extra Shelf, 15"d x 28"w, add \$63 List Price.					
	Extra Shelf, 15"d x 32"w, add \$75 List Price.					
FOUR DOORS						
	519-6036-□	15 x 60 x 36	226	4	1507	1662
	519-7236-□	15 x 72 x 36	264	4	1765	1944
	Extra Shelf, 15"d x 30"w, add \$63 List Price.					
	Extra Shelf, 15"d x 36"w, add \$75 List Price.					
SIX DOORS						
	519-8436-□	15 x 84 x 36	314	6	2099	2306
	519-9636-□	15 x 96 x 36	352	6	2358	2599
	Extra Shelf, 15"d x 28"w, add \$63 List Price.					
	Extra Shelf, 15"d x 32"w, add \$75 List Price.					

OPTIONS:

- Single door lock add \$50 list.
- Lock for pair of doors, add \$70 list.
- Arc pulls in polished chrome or satin chrome, no up charge.
- Master key, \$30.
- Key-change tool, \$30.
- Flush bottom (no fascia), no up charge.
- Task light not included; see accessories page 119.

NOTES:

- Doors are 7/8" thick with standard matte finish laminate.
- Standard color melamine case with 1/2mm pvc edgebanding.
- Single door units, specify hinge at left or right:
add "L" or "R" after "519" in model number.
- Three door units, specify single door at left or right:
add "L" or "R" after "519" in model number.
- Please specify edge detail at the end of the model number.
- Standard with Arc Pulls in black.
- Standard with recessed back and wall cleat.
- Standard with task light fascia.



phone: (510) 259-6217
email: info@actionlaminates.com

EDGE DETAILS

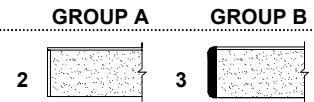

LAMINATE DOORS

**ECONOLINE
MELAMINE BASE CABINET, 18" DEEP X 34-3/4" HIGH**

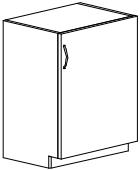
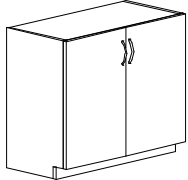
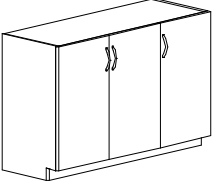
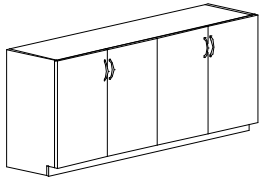
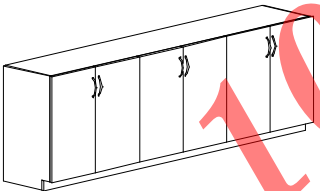
	MODEL NUMBER	SIZE	WT.	ADJ. SHELVES	Doors Only GROUP A	Doors Only GROUP B	
	D x W x H						
ONE DOOR		520-□-2436-□	18 x 24 x 34-3/4	90	1	604	656
		Extra Shelf, 18"d x 24"w, add \$63 List Price					
TWO DOORS		520-3036-□ 520-3636-□	18 x 30 x 34-3/4 18 x 36 x 34-3/4	106 122	1 1	713 822	782 897
		Extra Shelf, 18"d x 30"w, add \$75 List Price					
		Extra Shelf, 18"d x 36"w, add \$86 List Price					
THREE DOORS		520-□-4236-□ 520-□-4836-□	18 x 42 x 34-3/4 18 x 48 x 34-3/4	151 167	2 2	1006 1121	1116 1231
		Extra Shelf, 18"d x 28"w, add \$75 List Price					
		Extra Shelf, 18"d x 32"w, add \$86 List Price					
FOUR DOORS		520-6036-□ 520-7236-□	18 x 60 x 34-3/4 18 x 72 x 34-3/4	198 230	2 2	1340 1558	1478 1719
		Extra Shelf, 18"d x 30"w, add \$75 List Price					
		Extra Shelf, 18"d x 36"w, add \$86 List Price					
SIX DOORS		520-8436-□ 520-9636-□	18 x 84 x 34-3/4 18 x 96 x 34-3/4	275 306	3 3	1857 2082	2047 2289
		Extra Shelf, 18"d x 28"w, add \$75 List Price					
		Extra Shelf, 18"d x 32"w, add \$86 List Price					

OPTIONS:

- Worksurfaces on page 6.
- Single door lock add \$50 list.
- Lock for pair of doors, add \$70 list.
- Arc pulls in polished chrome or satin chrome, no up charge.
- Master key, \$30.
- Key-change tool, \$30.

NOTES:

- Standard with non-finished top and back.
- Standard with 3"d x 3"h toe kick.
- Standard with Arc Pulls in black.
- Doors are 7/8" thick with standard matte finish laminate.
- Standard color melamine case with 1/2mm pvc edgebanding.
- Single door units, specify hinge at left or right:
add "L" or "R" after "521" in model number.
- Three door units, specify single door at left or right:
add "L" or "R" after "521" in model number.
- Please specify edge detail at the end of the model number.



phone: (510) 259-6217
email: info@actionlaminates.com

EDGE DETAILS

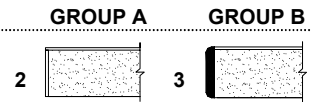

LAMINATE DOORS

**ECONOLINE
MELAMINE BASE CABINET, 18" DEEP X 40-3/4" HIGH**

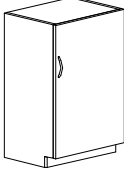
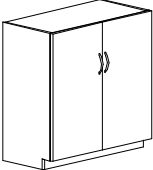
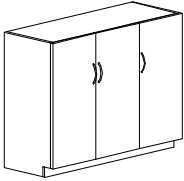
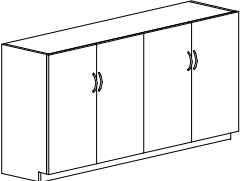
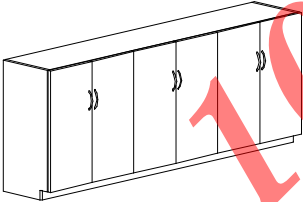
	MODEL NUMBER	SIZE	WT.	ADJ. SHELVES	Doors Only GROUP A	Doors Only GROUP B
ONE DOOR		D x W x H				
	520-□-2442-□	18 x 24 x 40-3/4	110	2	730	799
	Extra Shelf, 18"d x 24"w, add \$63 List Price					
TWO DOORS						
	520-3042-□	18 x 30 x 40-3/4	129	2	863	955
	520-3642-□	18 x 36 x 40-3/4	149	2	995	1093
	Extra Shelf, 18"d x 30"w, add \$75 List Price					
	Extra Shelf, 18"d x 36"w, add \$86 List Price					
THREE DOORS						
	520-□-4242-□	18 x 42 x 40-3/4	184	4	1225	1346
	520-□-4842-□	18 x 48 x 40-3/4	203	4	1369	1501
	Extra Shelf, 18"d x 28"w, add \$75 List Price					
	Extra Shelf, 18"d x 32"w, add \$86 List Price					
FOUR DOORS						
	520-6042-□	18 x 60 x 40-3/4	242	4	1633	1794
	520-7242-□	18 x 72 x 40-3/4	281	4	1898	2093
	Extra Shelf, 18"d x 30"w, add \$75 List Price					
	Extra Shelf, 18"d x 36"w, add \$86 List Price					
SIX DOORS						
	520-8442-□	18 x 84 x 40-3/4	336	6	2266	2490
	520-9642-□	18 x 96 x 40-3/4	375	6	2536	2789
	Extra Shelf, 18"d x 28"w, add \$75 List Price					
	Extra Shelf, 18"d x 32"w, add \$86 List Price					

OPTIONS:

- Worksurfaces on page 6.
- Single door lock add \$50 list.
- Lock for pair of doors, add \$70 list.
- Arc pulls in polished chrome or satin chrome, no up charge.
- Master key, \$30.
- Key-change tool, \$30.

NOTES:

- Standard with non-finished top and back.
- Standard with 3"d x 3"h toe kick.
- Standard with Arc Pulls in black.
- Doors are 7/8" thick with standard matte finish laminate.
- Standard color melamine case with 1/2mm pvc edgebanding.
- Single door units, specify hinge at left or right:
add "L" or "R" after "521" in model number.
- Three door units, specify single door at left or right:
add "L" or "R" after "521" in model number.
- Please specify edge detail at the end of the model number.



phone: (510) 259-6217
email: info@actionlaminates.com

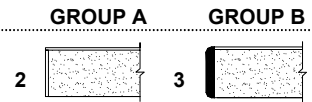

EDGE DETAILS



LAMINATE DOORS

ECONOLINE

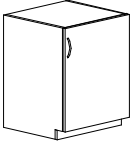
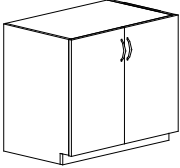
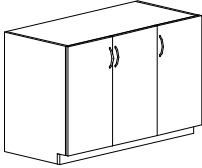
MELAMINE BASE CABINET, 23" DEEP X 34-3/4" HIGH

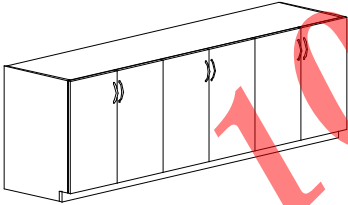
	MODEL NUMBER	SIZE	WT.	ADJ. SHELVES	Doors Only GROUP A	Doors Only GROUP B
D x W x H						
ONE DOOR						
	521-□-2436-□	23 x 24 x 34-3/4	108	1	713	782
	Extra Shelf, 23"d x 24"w, add \$75 List Price					
TWO DOORS						
	521-3036-□	23 x 30 x 34-3/4	126	1	840	914
	521-3636-□	23 x 36 x 34-3/4	144	1	960	1052
	Extra Shelf, 23"d x 30"w, add \$92 List Price					
	Extra Shelf, 23"d x 36"w, add \$109 List Price					
THREE DOORS						
	521-□-4236-□	23 x 42 x 34-3/4	180	2	1190	1305
	521-□-4836-□	23 x 48 x 34-3/4	198	2	1311	1438
	Extra Shelf, 23"d x 28"w, add \$92 List Price					
	Extra Shelf, 23"d x 32"w, add \$109 List Price					
FOUR DOORS						
	521-6036-□	23 x 60 x 34-3/4	234	2	1558	1719
	521-7236-□	23 x 72 x 34-3/4	270	2	1811	1984
	Extra Shelf, 23"d x 30"w, add \$92 List Price					
	Extra Shelf, 23"d x 36"w, add \$109 List Price					
SIX DOORS						
	521-8436-□	23 x 84 x 34-3/4	324	3	2162	2375
	521-9636-□	23 x 96 x 34-3/4	360	3	2404	2645
	Extra Shelf, 23"d x 28"w, add \$92 List Price					
	Extra Shelf, 23"d x 32"w, add \$109 List Price					

OPTIONS:

- Worksurfaces on page 6.
- Single door lock add \$50 list.
- Lock for pair of doors, add \$70 list.
- Arc pulls in polished chrome or satin chrome, no up charge.
- Master key, \$30.
- Key-change tool, \$30.

NOTES:

- Standard with non-finished top and back.
- Standard with 3"d x 3"h toe kick.
- Standard with Arc Pulls in black.
- Doors are 7/8" thick with standard matte finish laminate.
- Standard color melamine case with 1/2mm pvc edgebanding.
- Single door units, specify hinge at left or right:
add "L" or "R" after "521" in model number.
- Three door units, specify single door at left or right:
add "L" or "R" after "521" in model number.
- Please specify edge detail at the end of the model number.



phone: (510) 259-6217
email: info@actionlaminates.com

EDGE DETAILS

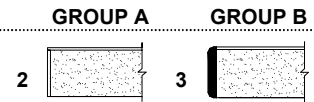

LAMINATE DOORS

**ECONOLINE
MELAMINE BASE CABINET, 23" DEEP X 40-3/4" HIGH**

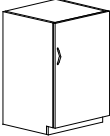
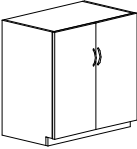
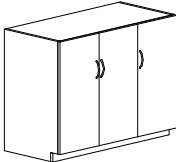
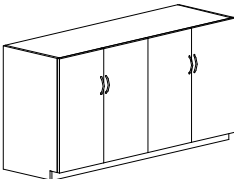
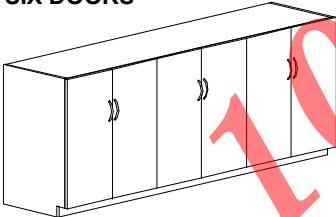
	MODEL NUMBER	SIZE	WT.	ADJ. SHELVES	Doors Only GROUP A	Doors Only GROUP B
D x W x H						
ONE DOOR						
	521-□-2442-□	23 x 24 x 40-3/4	132	2	868	955
	Extra Shelf, 23"d x 24"w, add \$75 List Price					
TWO DOORS						
	521-3042-□	23 x 30 x 40-3/4	155	2	1024	1121
	521-3642-□	23 x 36 x 40-3/4	177	2	1167	1288
	Extra Shelf, 23"d x 30"w, add \$92 List Price					
	Extra Shelf, 23"d x 36"w, add \$109 List Price					
THREE DOORS						
	521-□-4242-□	23 x 42 x 40-3/4	221	4	1455	1593
	521-□-4842-□	23 x 48 x 40-3/4	243	4	1604	1760
	Extra Shelf, 23"d x 28"w, add \$92 List Price					
	Extra Shelf, 23"d x 32"w, add \$109 List Price					
FOUR DOORS						
	521-6042-□	23 x 60 x 40-3/4	288	4	1915	2099
	521-7242-□	23 x 72 x 40-3/4	333	4	2214	2438
	Extra Shelf, 23"d x 30"w, add \$92 List Price					
	Extra Shelf, 23"d x 36"w, add \$109 List Price					
SIX DOORS						
	521-8442-□	23 x 84 x 40-3/4	399	6	2645	2910
	521-9642-□	23 x 96 x 40-3/4	444	6	2950	3249
	Extra Shelf, 23"d x 28"w, add \$92 List Price					
	Extra Shelf, 23"d x 32"w, add \$109 List Price					

OPTIONS:

- Worksurfaces on page 6.
- Single door lock add \$50 list.
- Lock for pair of doors, add \$70 list.
- Arc pulls in polished chrome or satin chrome, no up charge.
- Master key, \$30.
- Key-change tool, \$30.

NOTES:

- Standard with non-finished top and back.
- Standard with 3"d x 3"h toe kick.
- Standard with Arc Pulls in black.
- Doors are 7/8" thick with standard matte finish laminate.
- Standard color melamine case with 1/2mm pvc edgebanding.
- Single door units, specify hinge at left or right:
add "L" or "R" after "521" in model number.
- Three door units, specify single door at left or right:
add "L" or "R" after "521" in model number.
- Please specify edge detail at the end of the model number.



phone: (510) 259-6217
 email: info@actionlaminates.com

ECONOLINE MELAMINE WALL MOUNT MAIL ORGANIZER

MODEL NUMBER	SIZE	WT.	COLUMNS	ADJ. SHELVES	1/2 mm pvc edgebanding
D x W x H					
533-3018-□	14 x 30 x 18	98	3	18	638
533-4218-□	14 x 42 x 18	134	4	24	874
533-4818-□	14 x 48 x 18	154	5	30	1001
533-5418-□	14 x 54 x 18	169	5	30	1104
533-6018-□	14 x 60 x 18	190	6	36	1236
533-7218-□	14 x 72 x 18	226	7	42	1478
<hr/>					
533-3024-□	14 x 30 x 24	124	3	24	805
533-4224-□	14 x 42 x 24	169	4	32	1110
533-4824-□	14 x 48 x 24	195	5	40	1282
533-5424-□	14 x 54 x 24	214	5	40	1403
533-6024-□	14 x 60 x 24	240	6	48	1570
533-7224-□	14 x 72 x 24	285	7	56	1863
<hr/>					
533-3030-□	14 x 30 x 30	150	3	30	983
533-4230-□	14 x 42 x 30	204	4	40	1334
533-4830-□	14 x 48 x 30	236	5	50	1547
533-5430-□	14 x 54 x 30	258	5	50	1696
533-6030-□	14 x 60 x 30	290	6	60	1909
533-7230-□	14 x 72 x 30	344	7	70	2266
<hr/>					
533-3036-□	14 x 30 x 36	176	3	36	1156
533-4236-□	14 x 42 x 36	239	4	48	1576
533-4836-□	14 x 48 x 36	277	5	60	1823
533-5436-□	14 x 54 x 36	303	5	60	1995
533-6036-□	14 x 60 x 36	340	6	72	2237
533-7236-□	14 x 72 x 36	403	7	84	2657
<hr/>					
533-3048-□	14 x 30 x 48	228	3	48	1501
533-4248-□	14 x 42 x 48	310	4	64	2041
533-4848-□	14 x 48 x 48	359	5	80	2363
533-5448-□	14 x 54 x 48	391	5	80	2582
533-6048-□	14 x 60 x 48	440	6	96	2904
533-7248-□	14 x 72 x 48	522	7	112	3444

OPTIONS:

Extra melamine shelf, \$20 List.
 1/4" thick clear acrylic shelves, in place of melamine shelf, same price.



NOTES:

Standard color melamine with 1/2mm pvc edgebanding.
 3/4" thick case construction; shelves are 1/2" thick.
 Shelves adjust with metal pins on 1-1/4" centers.
 Standard with recessed back and wall cleat.
 Standard with flush bottom.

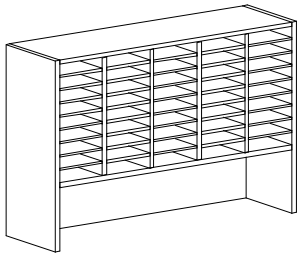

phone: (510) 259-6217
 email: info@actionlaminates.com

ECONOLINE MELAMINE MAIL ORGANIZER HUTCH UNITS

MODEL NUMBER	SIZE D x W x H	WT.	COLUMNS	ADJ. SHELVES	1/2 mm pvc edgebanding
534-3030-□	14 x 30 x 30	122	3	18	782
534-4230-□	14 x 42 x 30	164	4	24	1058
534-4830-□	14 x 48 x 30	190	5	30	1231
534-5430-□	14 x 54 x 30	207	5	30	1328
534-6030-□	14 x 60 x 30	233	6	36	1501
534-7230-□	14 x 72 x 30	276	7	42	1771
					
534-3036-□	14 x 30 x 36	148	3	24	955
534-4236-□	14 x 42 x 36	199	4	32	1294
534-4836-□	14 x 48 x 36	231	5	40	1495
534-5436-□	14 x 54 x 36	251	5	40	1633
534-6036-□	14 x 60 x 36	283	6	48	1834
534-7236-□	14 x 72 x 36	335	7	56	2174
					
534-3042-□	14 x 30 x 42	174	3	30	1121
534-4242-□	14 x 42 x 42	235	4	40	1524
534-4842-□	14 x 48 x 42	272	5	50	1765
534-5442-□	14 x 54 x 42	296	5	50	1926
534-6042-□	14 x 60 x 42	333	6	60	2168
534-7242-□	14 x 72 x 42	394	7	70	2565
					
534-3048-□	14 x 30 x 48	200	3	36	1300
534-4248-□	14 x 42 x 48	270	4	48	1760
534-4848-□	14 x 48 x 48	313	5	60	2036
534-5448-□	14 x 54 x 48	340	5	60	2214
534-6048-□	14 x 60 x 48	383	6	72	2496
534-7248-□	14 x 72 x 48	453	7	84	2961

OPTIONS:

Extra melamine shelf, \$20 List.
 1/4" thick clear acrylic shelves, in place of melamine shelf, same price.

NOTES:

Standard color melamine with 1/2mm pvc edgebanding.
 3/4" thick construction; shelves are 1/2" thick.
 Shelves adjust with metal pins on 1-1/4" centers.
 Standard with 12" height clearance below bottom shelf.
 Standard with fully enclosed back.
 Standard with attachment hardware.



phone: (510) 259-6217
 email: info@actionlaminates.com

ECONOLINE MELAMINE OPEN CUBBIE UNITS

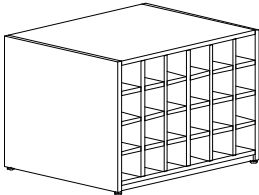
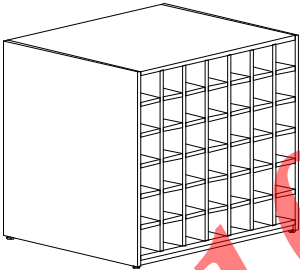
MODEL NUMBER	SIZE D x W x H	WT.	COLUMNS X ROWS	1/2 mm pvc edgebanding	
535-3029	29 x 30 x 29	225	5 x 4	1633	
535-3629	29 x 36 x 29	266	6 x 4	1932	
535-4229	29 x 42 x 29	308	7 x 4	2231	
535-4829	29 x 48 x 29	349	8 x 4	2530	
	535-3036	29 x 30 x 36	251	5 x 5	1823
	535-3636	29 x 36 x 36	297	6 x 5	2156
	535-4236	29 x 42 x 36	343	7 x 5	2484
	535-4836	29 x 48 x 36	389	8 x 5	2818
	535-3042	29 x 30 x 42	278	5 x 6	2007
	535-3642	29 x 36 x 42	328	6 x 6	2375
	535-4242	29 x 42 x 42	378	7 x 6	2743
	535-4842	29 x 48 x 42	428	8 x 6	3105
	536-3029	35 x 30 x 29	266	5 x 4	1932
	536-3629	35 x 36 x 29	315	6 x 4	2283
	536-4229	35 x 42 x 29	364	7 x 4	2634
	536-4829	35 x 48 x 29	413	8 x 4	2990
	536-3036	35 x 30 x 36	297	5 x 5	2156
	536-3636	35 x 36 x 36	351	6 x 5	2542
	536-4236	35 x 42 x 36	405	7 x 5	2933
	536-4836	35 x 48 x 36	459	8 x 5	3324
	536-3042	35 x 30 x 42	328	5 x 6	2375
	536-3642	35 x 36 x 42	387	6 x 6	2806
	536-4242	35 x 42 x 42	446	7 x 6	3237
	536-4842	35 x 48 x 42	506	8 x 6	3669

OPTIONS:

NOTES:

3/4" thick construction with standard color melamine and 1/2mm pvc edgebanding.
 Standard with fixed opening dimension.
 Standard with fully enclosed back.

Add
10% effective
7/1/2024



www.actionlaminates.com

3400 Investment Blvd. Hayward, CA 94545

Phone: 510-259-6217

Email: info@actionlaminates.com